

TOMGAST

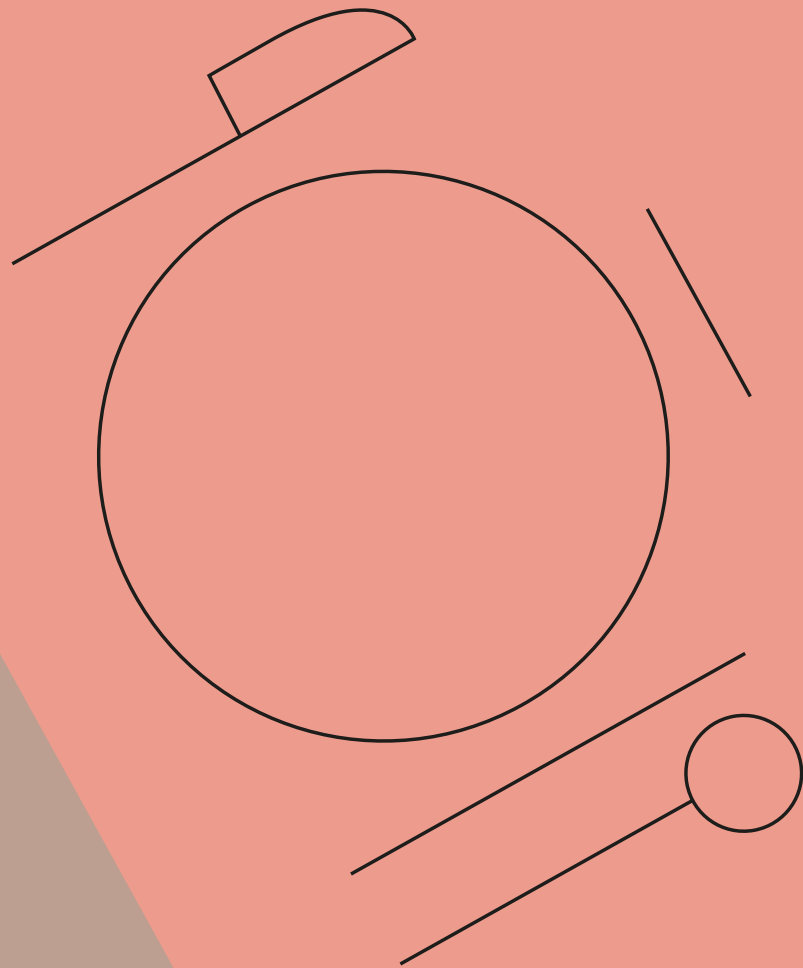

katalog 2024
HoReCa

Objaśnienie ikon / Icon explanation

	Lata gwarancji	<i>Guarantee years</i>
	Maksymalne obciążenie w kg	<i>Maximum load in kg</i>
	Należy natłuścić	<i>Grease the surface</i>
	Nie można myć w zmywarce	<i>Don't use with dishwasher</i>
	Możliwość logowania	<i>Personalization option</i>
	Odpowiednie na indukcję	<i>For induction cookers</i>
	Funkcja chłodzenia	<i>Cooling function</i>
	Spawana konstrukcja	<i>Welded construction</i>
	Wykonane ze szkła borowo-silikatowego	<i>Borosilicate glass</i>
	Gwarancja na wyszczerbienia	<i>Anti-chip guarantee</i>
	Możliwość sztaplowania	<i>Stackable</i>
	Zasilane grzałką elektryczną	<i>Powered by an electric heater</i>
	Zasilane paliwem	<i>Heated by fuel/paste</i>
	Nowość	<i>New</i>

Materiał, z którego został wykonany produkt jest ujęty w nazwie produktu.

Przykłady skrótów dla nazw materiałów:

18/10 – stal nierdzewna 18/10; ALU – aluminium; PP – polipropylen;
PE – polietylen; PC – poliwęglan

The name of the material used to make the product is included in the product name.

Examples of abbreviations for material names:

18/10 – stainless steel 18/10; ALU – aluminum; PP – polypropylene;

PE – polyethylene; PC – polycarbonate

TOMGAST

HISTORIA

JESTEŚMY Z WAMI OD

1998

We've been for you since 1998

ZAUFANIE PONAD

20 000 KLIENTÓW

Over 20000 Customers trust us

WYBÓR PONAD

7000

produktów w katalogu i na magazynie

More than 7000 references in the catalog and in stock

WYBÓR

POWIERZCHNIA
MAGAZYNOWA

7500 m²

zapewnia łatwą dostępność produktów naszym klientom

of storage spaces to meet all customers' needs

PRODUKTY WYSOKIEJ
JAKOŚCI ORAZ
RZETELNE DORADZTWO

quality and reliable products, honest consulting



ŚWIATOWE TRENDY

PONAD 700

nowych produktów każdego roku

OVER 700

novelties each year

JESTEŚMY eco

redukcja emisji CO₂ w skali roku, dzięki nowoczesnemu systemowi fotowoltaiki

36 000 kg

CO₂ reduction during the year thanks to the modern photovoltaic system



POZNAJ NAS

MEET OUR
COMPANY



#ECO

Tom-Gast buduje świadome relacje z otoczeniem. Dbamy o środowisko, w którym żyjemy! Działamy w długoterminowej perspektywie dla poprawy jakości gleby, powietrza i wody oraz prawidłowego rozwoju roślin i zwierząt.



Jak dbamy o środowisko?

- redukujemy emisję CO₂, optymalizując logistykę dostaw
- ograniczyliśmy do minimum plastik w ofercie sprzedażowej
- stawiamy na surowce eco – wszystkie jednorazowe, naczynka FINGERFOOD wyprodukowane są z biodegradowalnych surowców
- zadaliśmy o źródło odnawialnej energii dla organizacji naszej pracy
- stosujemy ZERO WASTE: oferujemy porcelanę z recyklingu No.W marki Revol, a produkty odrzucone w procesie kontroli jakości przekazujemy potrzebującym

Tom-Gast is a consciously building relations with the environment. We care about the environment in which we live! We act, in the long-term perspective, to improve the quality of soil, air and water as well as the proper live of plants and animals.

How do we care for the environment?

- we reduce CO₂ emissions by optimizing the logistics of deliveries
- we limited the plastic in the sales offer to a minimum
- we focus on ecoresources – all of our disposable FINGERFOOD dishes are made of biodegradable materials
- we provided a renewable energy and we use it in the organization of work
- we apply ZERO WASTE: offering recycled porcelain to the Polish market – No.W by Revol or handing over to those in need products rejected in the quality control process.



REVOL

Rewolucja w ochronie środowiska? TAK! Recyclay, pierwsza glina ceramiczna wykonana z odpadów przemysłowych. Aby pomóc chronić zasoby naszej planety, Revol przetwarza i ponownie wykorzystuje odpady przemysłowe, produkując No.W – designerskie porcelanowe naczynia najwyższej jakości, wykonane z gliny ceramicznej i emaliów pochodzących z recyklingu z własnej produkcji.

Recyclay, the first ceramic clay made from industrial waste. To help conserve our planet's resources, Revol recycles and reuses industrial waste, producing No.W – premium designer porcelain dishes are made from household ceramic clays.



Ekologiczne naczynia Weck w twojej restauracji, hotelu, barze = ZERO WASTE! Szkło jest najbardziej neutralnym tworzywem do przechowywania żywności. Nie jest podatne na działanie wysokiej temperatury, dzięki czemu nie wchodzi w interakcje z jedzeniem. Uszczelki wykonane są z naturalnego kauczuku, pozyskiwanego z kontrolowanych, legalnych plantacji (wolne od fenoli).

Ecological Weck dishes in your restaurant, hotel, bar = ZERO WASTE! Glass is the most neutral material for storing food. It is not susceptible to high temperatures, so it does not interact with food. The seals are made of natural rubber obtained from controlled, legal plantations (phenol free).

Verlo

Naczynka „fingerfood” jednorazowego użytku są biodegradowalne lub nadają się do recyklingu, a surowiec do asortymentu z drewna pozyskujemy z kontrolowanych upraw w Polsce.

Single-use „finger food” dishes are biodegradable or recyclable, and the raw material for the wood is obtained from assorted controlled crops in Poland.



RobuЯ

Tekstylia produkowane z certyfikowanych surowców OEKOTEX standard 100, są wolne od niekorzystnie wpływających na zdrowie ludzi środków (m. in. formaldehydów, pestycydów czy substancji alergizujących). Inicjatywa SEAQUEL, to wykorzystywanie do produkcji przędzy odpadów pochodzących z morza oraz postkonsumpcyjnego plastiku, wdrażanie systemów recyklingu zużytych tkanin i odzieży, recykling papieru i odpadów przemysłowych.

Textiles made of OEKOTEX standard 100 certified raw materials are free from substances that adversely affect human health (e.g. formaldehyde, pesticides or allergenic substances). The SEAQUEL initiative is the use of marine waste and post-consumer plastic for the production of yarn, implementation of recycling systems for used fabrics and clothing, recycling of paper and industrial waste.



Z WIESEL
GLAS

Innowacyjna technologia TRITAN® zapewnia, wyjątkową trwałość, a tym samym sprawia, że szkło jest przyjazne dla środowiska. Opatentowana masa kryształowa pozabawiona jest baru i ołowiu, co sprawia, że produkty te są bezpieczne dla zdrowia i naszej planety.

The innovative TRITAN® technology ensures exceptional durability and thus makes the glass environmentally friendly. The patented crystal mass is free of barium and lead, which makes these products safe for health and our planet.



Drewno używane do produkcji młynków Peugeot pochodzi z europejskich lasów i posiada etykietę PEFC™. Wióry i trociny z produkcji są odzyskiwane i poddawane recyklingowi. Do wykańczania drewnianych młynków stosuje się farby przyjazne dla środowiska i zdrowia.

The wood used to make Peugeot mills comes from European forests and carries the PEFC™ label. The shavings and sawdust from production are recovered and recycled. For the finishing of wooden mills, environmentally friendly and health-friendly paints are used.



Trwałość i solidność swoich produktów to cechy, którymi firma zachęca do odpowiedzialnej konsumpcji. Firma promuje model gospodarki o obiegu zamkniętym. Firma włączyła do swojej działalności demontaż zużytych produktów, po to, aby umożliwić recykling zużytych materiałów.

The durability and reliability of its are the true features by which the company encourages responsible consumption. The company promotes a circular economy model. Also, the company promotes a closed loop system to support a circular economy, including the dismantling of used products in its activities in order to enable recycling of used materials.

echtermann®
for professionals

Unijny zakaz przetwarzania trójtlenku chromu stanowi poważne wyzwanie dla naszego przemysłu. Otwarcie na innowację potraktowaliśmy tę zmianę jako okazję do zainicjowania zmiany. Stopniowo przekształcamy naszą ofertę produktów z mosiądzu na stal nierdzewną – i opieramy się na strategii premium.

We are well prepared for the future. Our industry is facing great challenges due to the EU ban on processing chromium trioxide. Due to our enjoyment in innovations, we have taken this change as an opportunity to undergo a transformation process. We are gradually converting our product portfolio from the material brass to stainless steel – while pursuing a premium strategy.

NASZE USŁUGI

OUR SERVICE



SPECJALNA DOSTAWA W 24 GODZINY NA TERENIE KRAJU
Delivery in 24 hours throughout the country



SKLEP INTERNETOWY
Online store



PLATFORMA B2B – KOMFORTOWE SKŁADANIE ZAMÓWIEŃ
B2B platform - a comfortable way of placing orders



ZESPÓŁ PROFESJONALNYCH DORADCÓW
A team of professional consultants



PROGRAM SZKOLEŃ PRODUKTOWYCH
Product training program



DEDYKOWANY OPIEKUN KLIENTA B2B
Dedicated B2B customer service



4 SKLEPY / SHOWROOMY NA TERENIE POLSKI
4 shops / showrooms in Poland



WARSZAWA



ŁÓDŹ



GDAŃSK



KRAKÓW

**ZAOBSERWUJ
NAS!**
FOLLOW US!

 @tomgast1998

 @tomgast_polska

Spis treści | *Table of contents*

6	ODZIEŻ <i>CLOTHING</i>
24	GARNKI I PATELNIĘ <i>POTS & FRYING PANS</i>
40	POJEMNIKI GASTRONOMICZNE <i>GN CONTAINERS</i>
48	AKCESORIA KUCHENNE <i>KITCHEN ACCESORIES</i>
116	ARMATURA <i>ARMATURE</i>
124	URZĄDZENIA I KUCHNIA NOWOCZESNA <i>MODERN KITCHEN & EQUIPMENT</i>
148	CUKIERNICTWO <i>PASTRY</i>
180	PIZZA <i>PIZZA</i>
190	CATERING <i>CATERING</i>
198	Verlo BUFET I DODATKI STOŁOWE <i>Verlo BUFFET & TABLEWARE</i>
288	SŁOIKI WECK <i>WECK JARS</i>
298	PORCELANA I DODATKI STOŁOWE <i>PORCELAIN & TABLEWARE</i>
	— 298 – Verlo
	— 338 – RAK
	— 414 – Revol
442	SZTUĆCE <i>CUTLERY</i>
	— 442 – Verlo
	— 454 – ETERNUM
476	SZKŁO I KOSZE DO SZKŁA <i>DRINKING GLASS & GLASS RACKS</i>
528	MŁYNKI <i>MILLS</i>
536	BAR I KAWIARNIA <i>BAR & CAFÉ</i>
575	OUTLET



Francuski producent kitli i odzieży gastronomicznej, sięgający historią 1922 roku. Zarówno najlepsi szefowie kuchni z całego świata, jak i młodzi adepci sztuki kulinarnej doceniają przedstawianie najnowszych trendów fashion w sektorze profesjonalnym horeca.

Robur is a French manufacturer of professional wear. The brand has been on the market since 1922. In its offer there are cooking jackets, kitchen aprons used by the best chefs as well as children's sets for young adepts of culinary art.

SEAQUAL
INITIATIVE



TENCEL™

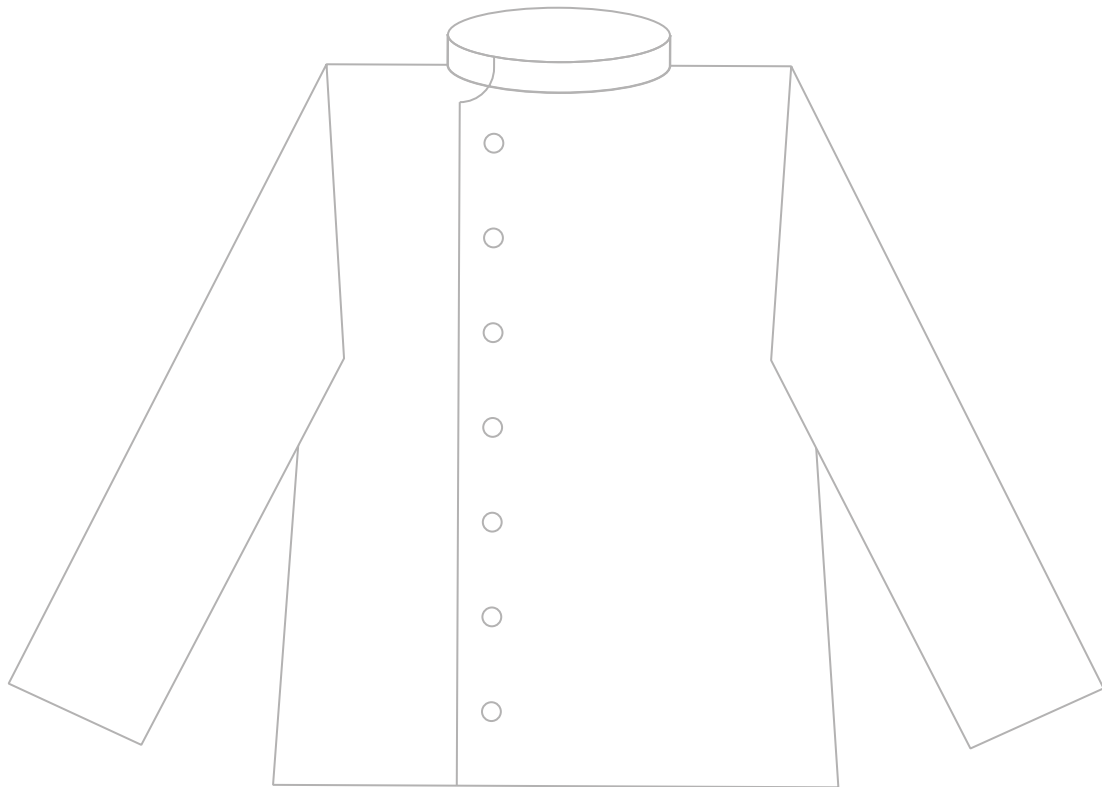

MADE IN FRANCE

profesjonalizm

Szeroki wybór rozmaitych krojów i zaawansowanych technologicznie tkanin dla komfortu i ergonomii.

professionalism: The Robur brand has a wide range of outfits for professional kitchen use.

Nieustający rozwój i bycie liderem w swojej dziedzinie to założenia Robur. Duża różnorodność produktów, z zachowaniem dbałości o każdy najmniejszy detal sprawia, że każda kolekcja jest jeszcze lepsza od poprzedniej.

It is a company that constantly focuses on development in order to be a market leader in its field. The offer is characterised by a huge variety of products so that everyone can find something suitable for themselves.

trendy

Dla profesjonalistów trendy to nie tylko cechy wizualne, ale także jakość materiałów i wykonania. Komfort termiczny użytkownika, czy łatwość czyszczenia, to dla Robura priorytet.

trends: Robur products are characterised by comfort, high quality, ease of cleaning, innovative fabric technologies, remarkable resistance and they always follow current fashion trends.

KUP ON-LINE

Możliwość personalizacji (logo, podpis, hasło, grafika itd.) – o szczegóły zapytaj sprzedawcę
 Personalize your ROBUR product by adding a logo, caption, a catchphrase or a graphic element – ask for details



Objaśnienie symboli i rozmiarówka odzieży | Symbol definition and size charts

Długi rękaw Long Sleeve	Krótki rękaw Short Sleeve	Rękaw 3/4 3/4 lengthsleeve	Dł. i kr. rękaw Long and short-sleeved	Krój dopasowany Slim	Krój dopasowany Slim	Tk. antibakteryjna Antibacterial	Tk. antyfalowa Anti-wave	Tk. antypotowa Anti-odour	Tk. antystatyczna Antistatic	Męskie Men
Kontrola temp. Controls temp.	Tk. szybko schnąca Fast dry	Tk. oddychająca Breathable	Tk. komfortowa Comfort	X-Static Srebro X-Static	100% Bawełna 100% Cotton	Polibawełna Polyester Cotton	Bawełna Poli Cotton Polyester	Bawełna Poli Elastyczna Cotton Polyester Elasthane	Bawełna Poli Elastyczna Polyester Cotton Elasthane	Damskie Women
Polibawełna Natura Polyester Cotton Natura	Polibawełna T400 Polyester Cotton T400	Bawełna elastyczna Cotton Elastane	Poliester Tencel Polyester Tencel	Poliester Tencel Seaqual Polyester Tencel Seaqual	Wiskoza Viscose	PVC PVC	Pranie przemysłowe zgodne z normą ISO 15797 – BIEL Industrial washing, compatible according to ISO 15797 – Whites	Pranie przemysłowe zgodne z normą ISO 15797 – KOLOR Industrial washing, compatible according to ISO 15797 – Colours	Unisex Unisex	



TENCEL® – INNOWACYJNY materiał – bardziej chłonny od bawełny, bardziej miękki od jedwabiu, chłodniejszy niż len
 Textiles made with TENCEL® are more absorbent than cotton, softer than silk and cooler than linen

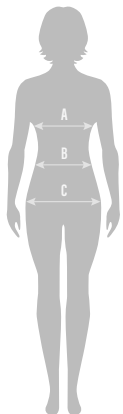

Rozmiarówka bluz i spodni damskich | Women blouses size chart

Rozmiar size		A – obwód w klatce bust		B – obwód w pasie waist		C – obwód w biodrach hips	
FR	PL	Rozm. size	(cm)	Rozm. size	(cm)	Rozm. size	(cm)
0	XS	34–36	78–85	34–36	60–67	34–36	84–92
1	S	38–40	86–93	38–40	68–75	38–40	93–100
2	M	42–44	94–101	42–44	76–83	42–44	101–108
3	L	46–48	102–109	46–48	84–91	46–48	109–116
4	XL	50–52	110–117	50–52	92–99	50–52	117–124
5	XXL	54–56	118–125	54–56	100–107	54–56	125–131
6	XXXL	58–60	126–133	58–60	108–115	58–60	132–139

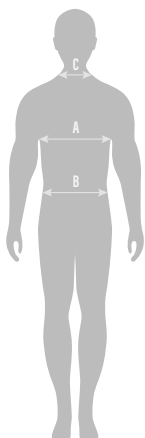

Rozmiarówka bluz i spodni męskich i unisex | Men and unisex blouses and trousers size chart

Rozmiar size		A – obwód w klatce chest		B – obwód w pasie waist		C – kołnierz collar
FR	PL	Rozm. size	(cm)	Rozm. size	(cm)	(cm)
0	XS	38–40	74–81	34–36	66–73	35–36
1	S	42–44	82–89	38–40	74–81	37–38
2	M	46–48	90–97	42–44	82–89	39–40
3	L	50–52	98–105	46–48	90–97	41–42
4	XL	54–56	106–113	50–52	98–105	43–44
5	XXL	58–60	114–121	54–56	106–113	45–46
6	XXXL	62–64	122–129	58–60	114–121	47–48

KUP ON-LINE





RAZEM DLA CZYSTYCH OCEANÓW

SEAQUAL INITIATIVE to organizacja, która zwiększa świadomość istnienia problemu odpadów morskich działa na rzecz oczyszczania oceanów.

Przędza SEAQUAL® YARN jest wytwarzana w 10% z odpadów wyłowionych z morza i w 90% z postkonsumpcyjnego plastiku PET pochodzącego ze źródeł lądowych.

Odzyskany z wody plastik jest przetwarzany na przędzę SEAQUAL® YARN, czyli włókno poliestrowe pochodzące w 100% z recyklingu, które trafia ponownie do fabryk, gdzie tworzy się z niego nowe, zrównoważone środowiskowo produkty.

TOTAL FOR CLEAN OCEANS

SEAQUAL INITIATIVE is a community of people, organizations and companies working together to help cleanse our oceans and raise awareness of the problem of marine litter.

SEAQUAL® YARN yarn is made from 10% of saltwater catches and 90% of post-consumer PET plastic fromland-based sources.

The plastic recovered from the water is processed into SEAQUAL® YARN, a 100% recycled polyester fiber that is returned to factories to create new, environmentally sustainable products.

SEAQUAL INITIATIVE



Escale

Nr kat.	rękaw	rozmiary	PLN	EUR
○ U-ES-WTS	krótki	XS - XXL	331,27	-
● U-ES-BLS	długi	XS - XXL	331,27	-

Poliester Tencel Seaqual 185g/m2 • Oddychająca, szybkoschnąca tkanina, bluza dopasowana do sylwetki (taliowana) • Siateczka pod ramionami, kontrastowe lamówki

Polyester Tencel Seaqual 185g/m2 • Breathable • Fast dry • Fitted jacket • Mesh yokes under arms • Contrasting edging on front side cut-outs





Elbax

Nr kat.	rękaw	rozmiary	PLN	EUR
○ U-EL-BLS	długi	XS - XXL	234,08	-

Polibawełna 215g/m² (65% poliester, 35% bawełna) • Oddychająca tkanina • Ukryte zatrzaski • Wstawka z oddychającej tkaniny po bokach • Kieszonki na piersi i rękawie

Polyester Cotton 215g/m² • Breathable fabric • Concealed press studs • Breathable fabric insert on the sides • Pocket on the chest and sleeve



Expression

Nr kat.	rękaw	rozmiary	PLN	EUR
○ U-EX-GLS	długi	XS - XXXL	234,08	-
○ U-EX-GTS	krótki	XS - XXXL	234,08	-
○ U-EX-WLS	długi	XS - XXXL	234,08	-

Polibawełna 215 g/m² • Oddychająca tkanina dżersejowa po bokach dla komfortu termicznego • Ukryte zatrzaski • Kieszonki na piersi i rękawie

Polycotton 215 g/m² • Breathable mesh strip on sides • Hidden snaps • Sleeve pen pocket and breast pocket



KUP ON-LINE



Technologia 37.5® utrzymuje temperaturę ciała na idealnym poziomie. Cząsteczki 37.5® pochodzą z naturalnych materiałów - cząsteczek lawy wulkanicznej.

Para wytworzona z potu, tworząca się podczas aktywności, chłodzi nasze ciało podczas pracy. Jeśli para wodna nie może zostać usunięta z odzieży, obuwia lub rękawic, gromadzi się i tworzy wilgotny, nieprzyjemny mikroklimat. Technologia 37.5® wzmacnia naturalny mechanizm chłodzenia - organizm wytwarza pot, aby się schłodzić, zaś technologia 37.5® skutecznie usuwa go z odzieży.



Aktywne cząsteczki 37.5® zwiększają wydajność i komfort pracy

37.5® active particles increase performance and comfort



Technologia 37.5® pomaga rozgrzać się, gdy jest Ci zimno i ochłodzić Cię, gdy jest Ci gorąco

37.5® technology helps warm you up when you're cold and cool you down when you're hot



Technologia 37.5® pomaga zachować optymalną wilgotność

37.5® technology helps you maintain a comfortable personal microclimate relative humidity of 37.5%



Technologia 37.5® usuwa pot już w fazie parowania i nie dopuszcza do powstania ciekłego potu

37.5® technology removes sweat in the vapor stage before liquid sweat forms



Cząsteczki aktywne 37.5® są pochodzenia naturalnego

37.5® active particles are derived from nature



Technologia 37.5® zatrzymuje zapachy, a następnie uwalnia je podczas prania i suszenia

37.5® technology traps odors and then releases them when washed and dried



Technologia 37.5® działa przez cały okres użytkowania odzieży

37.5® technology works for the life of the garment/clothing



The 37.5® technology keeps your body temperature at an ideal level. The 37.5® particles come from natural materials - volcanic lava particles.

The steam of sweat that comes out during activity cools our body, when it's easily evaporated thanks to 37.5® technology.

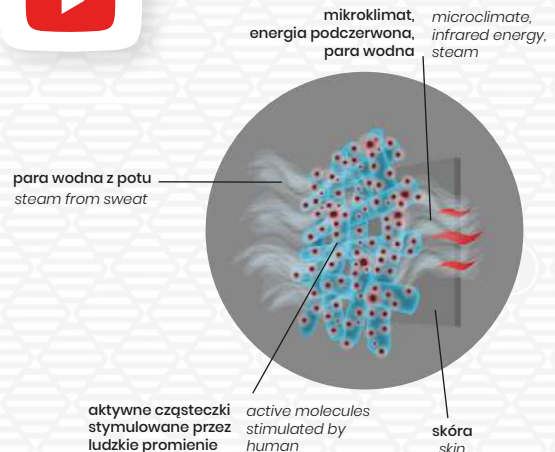

Cavane

Nr kat.	rękaw	rozmiary	PLN	EUR
0 U-CV-WLS	długi	XS - XXL	331,27	-

Polibawełna 37.5® 170g/m2 (65% poliester, 35% bawełna) • Oddychająca, szybkoschnąca, kontrolująca temperaturę, antyzapachowa tkanina • Ukryte zatrzaski • Siateczkowa wstawka po bokach

Polyester Cotton 37.5® 170g/m2 • Breathable • Fast dry • Controls temperature • Anti-odor • Snap buttons • Mesh insert on the sides





Cadix

Nr kat.	rękaw	rozmiary	PLN	EUR
● U-CX-BTS	krótki	XS - XXL	331,27	-

Polibawełna 37.5@ 170g/m2 • Oddychająca, szybkoschnąca, kontrolująca temperaturę antyzapachowa tkanina • Stójka • Ukryte zatrzaski • Wstawka z oddychającej tkaniny na ramionach • Kieszeń na lewym rękawie • Rozcięcia boczne

Polyester Cotton 37.5@ 170g/m2 • Breathable, quick-drying, temperature-controlling anti-odor fabric • Stand-up collar • Concealed press studs • Breathable fabric insert on the shoulders • Left sleeve pocket • Side slits



Unera

Nr kat.	rozmiary	PLN	EUR
● U-UN-BTS	XS-XXXL	187,06	-
● U-UN-GTS	XS-XXXL	187,06	-
● U-UN-PTS	XS-XXXL	187,06	-
● U-UN-RTS	XS-XXXL	187,06	-
○ U-UN-WTS	XS-XXXL	187,06	-

Polibawełna 195 g/m2 • Ukryte zatrzaski • Kieszeń na rękawie
Cotton Polyester 195 g/m2 • Hidden snaps • Sleeve pen pocket



KUP ON-LINE

SEAQUAL
INITIATIVE

Więcej informacji na str. 8



Dunes

Nr kat.	rękaw	rozmiary	PLN	EUR
● U-DU-BTS	krótki	XS - XXXL	331,27	-
○ U-DU-WLS	długi	XS - XXXL	331,27	-

Poliester Tencel Seaqual 185g/m² • Oddychający ekologiczny, szybkoschnący materiał i ukryte zatrzaski • Siatkowa wstawka pod pachami • Kieszonki na piersi • Kontrastowe lamówki

Polyester Tencel Seaqual 185g/m² • Breathable, ecological and fast dry textiles • Hidden snap buttons • Underarm mesh insert • Weltd breast pocket • Contrasting piping



Tencel



Bergame

Nr kat.	rozmiary	PLN	EUR
● U-BE-BLS	XS-XXXL	349,03	-

Tencel 195 g/m² • Asymetryczna listwa zapięcia • Panel naramienny • Ukryte zatrzaski • Kieszonki na piersi • Rozcięcia po bokach

Tencel 195 g/m² • Asymmetrical button placket • Panel on shoulder • Hidden snaps • Piped sleeve pocket • Slits on cuffs

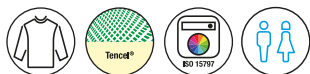



Siaka

Nr kat.	rękaw	rozmiary	PLN	EUR
● U-SI-GLS	długi	XS - XXXL	319,77	-
● U-SI-GTS	krótki	XS - XXXL	319,77	-

Polibawełna 160 g/m2 (67% poliester, 33% bawełna) - najwyższej jakości bawełna z fakturą „wafle” + unikalna, oddychająca tkanina po bokach • Stójka podszyta wewnątrz miękką frotte • Ukryte zatrzaski • Kieszon na rękawie • Rozcięcia z tyłu

Polycotton 160 g/m2 waffle texture • Unique, breathable fabric on the sides • Stand-up collar lined inside with a soft terry cloth • Concealed press studs • Pocket on the sleeve • Slits at the back



tkanina „wafel”

kieszon na rękawie



ukryte zatrzaski

tkanina oddychająca po bokach



rozcięcia z tyłu

stójka frotte





Siaka

Nr kat.	rękaw	rozmiary	PLN	EUR
● U-SI-BLS	długi	XS - XXXL	319,77	-
● U-SI-BTS	krótki	XS - XXXL	319,77	-

Polibawełna 160 g/m² (67% poliester, 33% bawełna) - najwyższej jakości bawełna z fakturą „wafła” + unikalna, oddychająca tkanina po bokach • Stójka podszyta wewnątrz miękką frotte • Ukryte zatrzaski • Kieszon na rękawie • Rozcięcia z tyłu

Polycotton 160 g/m² waffle texture • Unique, breathable fabric on the sides • Stand-up collar lined inside with a soft terry cloth • Concealed press studs • Pocket on the sleeve • Slits at the back



Siaka

Nr kat.	rękaw	rozmiary	PLN	EUR
○ U-SI-WLS	długi	XS - XXXL	319,77	-
○ U-SI-WTS	krótki	XS - XXXL	319,77	-

Polibawełna 160 g/m² (67% poliester, 33% bawełna) - najwyższej jakości bawełna z fakturą „wafła” + unikalna, oddychająca tkanina po bokach • Stójka podszyta wewnątrz miękką frotte • Ukryte zatrzaski • Kieszon na rękawie • Rozcięcia z tyłu

Polycotton 160 g/m² waffle texture • Unique, breathable fabric on the sides • Stand-up collar lined inside with a soft terry cloth • Concealed press studs • Pocket on the sleeve • Slits at the back

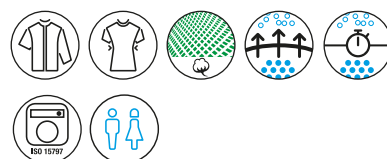



Więcej informacji na str. 10



Bolt

Nr kat.	rękaw	rozmiary	PLN	EUR
○ U-BO-WTS	krótki	XS - XXXL	274,84	-

Polibawełna 37.5® 170g/m2 • Wstawki siatkowe 37.5® na bokach • Stójka • Kontrastowe szwy na przodzie odzieży i na kołnierzu • Ukryte zatrzaski

Polyester Cotton 37.5® 170g/m2 • 37.5® mesh inserts on the sides of the garment • Mandarin collar • Contrasted topstitching on garment front and on the collar • Hidden snap buttons

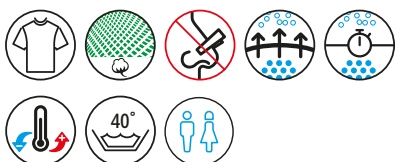

Więcej informacji na str. 10



Broto

Nr kat.	rozmiary	PLN	EUR
○ U-BR-WLS	XS-XXXL	391,88	-

Polibawełna 170 g/m2 • Siatkowa tkanina 37,5® po bokach i na ramionach • Ukryte zatrzaski • Kieszeń na rękawie • Rozcięcia na mankietach

Polycotton 170 g/m2 • Mesh additions on the sides and panels on the shoulders and collar • Hidden snaps • Piped sleeve pocket • Slits on the cuffs

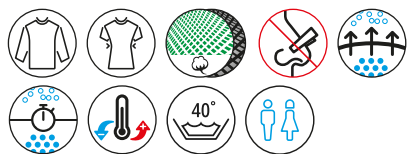

KUP ON-LINE



Energy

Nr kat.	rękaw	rozmiary	PLN	EUR
U-EN-GLS	długi	XS - XXXL	234,08	-
U-EN-GTS	krótki	XS - XXXL	234,08	-
U-EN-WLS	długi	XS - XXXL	234,08	-

Polibawełna 215 g/m² • Oddychająca tkanina dżersejowa po bokach dla komfortu termicznego • Ukryte zatrzaski • Kieszeń na piersi i rękawie

Polycotton 215 g/m² • Breathable mesh strip on sides • Hidden snaps • Sleeve and breast pocket



Bovi

Nr kat.	rozmiary	PLN	EUR
U-BR-JLS	XS-XXXL	349,03	-

100% Bawełna 155 g/m² • Zatrzaski w kolorze miedzi • Listwa z zatrzaskami, stojka i mankiety od wewnątrz oraz przeszycia w kontrastowym kolorze granatowym

100% Cotton 155 g/m² • Brass capped snaps • Button placket, neckband inside the collar, sleeve slit inside and topstitching in contrasting blue





Nero

Nr kat.	rozmiary	PLN	EUR
● U-NE-ALS	XS - XXXL	187,06	-
● U-NE-BLS	XS - XXXL	187,06	-
● U-NE-FLS	XS - XXXL	187,06	-
● U-NE-PLS	XS - XXXL	187,06	-

Polibawełna 195 - 215 g/m2 (w zależności od koloru) • Ukryte zatrzaski • Kieszonki na rękawie

Polycotton 195 - 215 g/m2 (depending on colour) • Hidden snaps • Sleeve pocket



Nero

Nr kat.	rozmiary	PLN	EUR
● U-NE-BTS	XS - XXXL	187,06	-
● U-NE-GTS	XS - XXXL	187,06	-
● U-NE-JTS	XS - XXXL	211,09	-
● U-NE-MTS	XS - XXXL	187,06	-
● U-NE-RTS	XS - XXXL	187,06	-
● U-NE-TTS	XS - XXXL	187,06	-
○ U-NE-WTS	XS - XXXL	187,06	-

Polibawełna 195 - 215 g/m2 (w zależności od koloru) • Ukryte zatrzaski • Kieszonki na rękawie

Polycotton 195 - 215 g/m2 (depending on colour) • Hidden snaps • Sleeve pocket



biała bluza
z wyjątkiem
denim



KUP ON-LINE





Więcej informacji na str. 10



Caden

Nr kat.	rozmiary	PLN	EUR
● U-CA-B	XS - XXXL	331,27	-

Polibawełna 37.5® 170g/m² • Oddychająca tkanina, kontrolująca temperaturę ciała • Pas ze szlufkami • 2 włoskie kieszenie z przodu z kontrastowym przeszyciem • 1 tylna kieszeń ze ściągaczem • Metalowe zapięcie na guzik i suwak

Polyster Cotton 37.5® 170g/m² • Breathable • Fast dry • Controls temperature • Waistband with loops • 2 italian pockets in front with contrast bias • 1 rear welt pocket • Metal button closure and zip

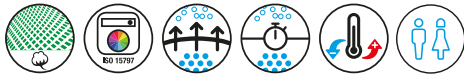

Austin

Nr kat.	rozmiary	PLN	EUR
● U-AU-D	XS - XXXL	438,90	-

Bawełna ze strechem 250 g/m² • Elastyczny pasek • Przednie kieszenie typu western • 2 naszyte kieszenie z tyłu • Dopasowany krój

Polycotton Elastane 250 g/m² • Elastic waistband • Zipper • Western front pockets • 2 back patch pockets • Slim - cut



Umini

Nr kat.	rozmiary	PLN	EUR
● U-UI-B	XS - XXXL	144,21	-
○ U-UI-W	XS - XXXL	144,21	-

Polibawełna 195 - 215 g/m² (w zależności od koloru) • Guma w pasie • Kieszenie boczne na szwie • Podwijane nogawki z zatraskami

Polycotton 195 - 215 g/m² (depending on colour) • Elastic waistband • Seamed side pockets • Leg bottoms with snaps for adjusting



Rosace

Nr kat.	rozmiary	PLN	EUR
● U-RO-G	XS - XXXL	229,90	-

Polibawełna 195 g/m² • Elastyczny pas z oddychającą tkaniną dżersejowej • 1 tylna kieszonka zapinana na zatrask • Strzałkowe przeszycia na kolanach

Polycotton 195 g/m² • Natura® mesh elastic waistband • 1 snap-buttoned back pocket • Darts on knees





Oural

Nr kat.	rozmiary	PLN	EUR
● U-OR-G	XS - XXXL	148,39	-

100% bawełna 260 g/m² • Pasek z elastycznymi bokami • Rozporek zapinany na guziki • 2 kieszenie przednie i 1 tylna zapinana na guzik

100% Cotton 260 g/m² • Waistband with elastic sides • Fly fastened with buttons • 2 front pockets and 1 back pocket fastened with a button



Arenal

Nr kat.	rozmiary	PLN	EUR
● U-AR-B	XS - XXXL	358,44	-
● U-AR-G	XS - XXXL	358,44	-

Polibawełna 195 g/m² • Elastyczny, regulowany na rzep pas frotte zapewnia wysoki komfort termiczny • Zamek błyskawiczny • Przednie kieszenie typu western, wąska boczna na nogawce i jedna tylna • Strzałkowe przeszycia na kolanach

Polycotton 195 g/m² • Terry cloth elastic waistband • Zipper • Western front pockets • Piped back pocket and thigh-side phone pocket • Darts on knees



Blino

Nr kat.	rozmiary	PLN	EUR
● U-BL-G	XS-XXXL	266,48	-

Polibawełna ze strechem 200 g/m² • Zapinanie na zamek i guzik • 2 kieszenie z przodu, jedna kieszeń z tyłu

Polycotton Elastane 200 g/m² • Front zip and metallic button fastening • 2 Italian front pockets, 1 piped back pocket



Archet

Nr kat.	rozmiary	PLN	EUR
● U-AR-A	XS - XXXL	337,54	-

Polibawełna 195 g/m² • Elastyczny pasek frotte • Rozporek na suwak • Przednie kieszenie typu western • Wszyta tylna kieszeń

Polycotton 195 g/m² • Terry cloth elastic waistband • Zipper • Western front pockets • Piped back pocket



KUP ON-LINE



Parme

Nr kat.	PLN	EUR
○ U-PA-W	126,97	-

PVC 475 g/m², wodoodporne • Spełnia wymagania Dyrektywy Europejskiej 89/686/EEC • Regulowany pasek • Dł. paska: 89 cm, wys. 100 cm, szer. 75 cm

PVC 475 g/m², waterproof • Complies with the requirements of the European Directive 89/686/EEC • Adjustable neckband

PVC



Vignoble

Nr kat.	PLN	EUR
● U-VN-J	197,51	-

100% Bawełna 200 g/m², denim • Pasek z kłama do regulacji długości • Naszyta kieszeń z klapą • Dł. paska: 100 cm, wys. 90 cm, szer. 89,5 cm • Pasuje do Verveine i Vincho

100% Cotton 200 g/m², denim look • Adjustable neckband with buckle • Patch pockets, pen pocket with flap • Short denim belt: 100 cm Height: 90 cm /Width: 89.5 cm • Matching jackets: VERVEINE - VINHO



Vini

Nr kat.	PLN	EUR
● U-VI-M	170,34	-

Bawełna / Poliester 275 g/m² • Pasek z zatraskami do regulacji długości • Przędz zszyty na zakładkę • Można prac przemysłowo • Dł. paska: 100 cm, wys. 90 cm, szer. 89,5 cm

Cotton Polyester 275 g/m² • Adjustable neckband with snaps • Patch pocket • Crossed front middle slit • Short denim belt: 100 cm Height: 90 cm /Width: 89.5 cm



Var

Nr kat.	PLN	EUR
● U-VR-B	186,01	-

Polibawełna 200 g/m² • Pasek z zatraskami do regulacji długości • Kieszeń w pasie • Dł. paska tylniego: 54,5 cm, wys. 91,5 cm, szer. 84,5 cm

Polycotton 200 g/m² • Neckband with snaps for adjusting • Pockets in waist • Cumberbund belt • Crossed front middle slit • Short belt with back tie: 54.5 cm, Height: 91.5 cm /Width: 84.5



Porto

Nr kat.	PLN	EUR
● U-PO-B	44,41	-
○ U-PO-W	44,41	-

100% Bawełna 245 g/m² • Dł. paska: 100 cm, wys. 90 cm, szer. 105 cm

100% Cotton • Tie belt Height: 90 cm, Width: 105 cm, Belt length: 100 cm



SEAQUAL INITIATIVE

Więcej informacji na str. 8



Dax

Nr kat.	PLN	EUR
● U-DX-B	132,72	-
● U-DX-N	132,72	-
● U-DX-O	132,72	-

Tencel Poliester Seaqual 185g/m² • Kieszzeń na długopis na lewej klapie • Regulowany pasek na szyję z zatrzaskami • Kieszzeń po lewej stronie

Tencel Polyester Seaqual 185g/m² • Pen pocket on left side flap • Adjustable fabric neck strap with snap buttons • Pocket on left side

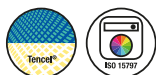

Pise

Nr kat.	PLN	EUR
● U-PI-B	55,39	-
○ U-PI-W	55,39	-

100% Bawełna 245 g/m² • Duża frontowa kieszeń • Dł. paska: 100 cm, wys. 100 cm, szer. 105 cm

100% Cotton • Large central pocket • Neckband length: 60 cm, Height: 100 cm, Width: 105 cm, Belt length: 100 cm



Loti

Nr kat.	PLN	EUR
● U-LO-G	111,82	-
● U-LO-M	111,82	-
● U-LO-C	111,82	-
● U-LO-P	111,82	-
● U-LO-Z	111,82	-

Polibawełna 195-210 g/m² (w zależności od koloru) • Regulowany pasek na na zatrzaski • 1 kieszeń na biodrze • Dł. paska: 110 cm, wys. 90 cm, szer. 70 cm

Polycotton 195-210 g/m² • Neckband with snaps for adjusting • Side pen pocket • 1 low pocket on left-side • Fabric belt: 110 cm, Height: 90 cm, Width: 70 cm



KUP ON-LINE





Elder

Nr kat.	PLN	EUR
● U-ED	170,34	-

Polibawełna 245g/m² • Pasek Sommeliera z regulacją kłamy • Zapięcie na haczyk • 5 Kieszoni: 2 duże z przegródkami, kieszeń z zamkiem i 2 kieszenie na długopisy

Polycotton/ Cotton Polyester 245g/m² • Sommelier's belt with buckle adjustment • Hook fastening • 5 pockets: 2 large compartmentalised pockets, zippered pocket and 2 pen pockets

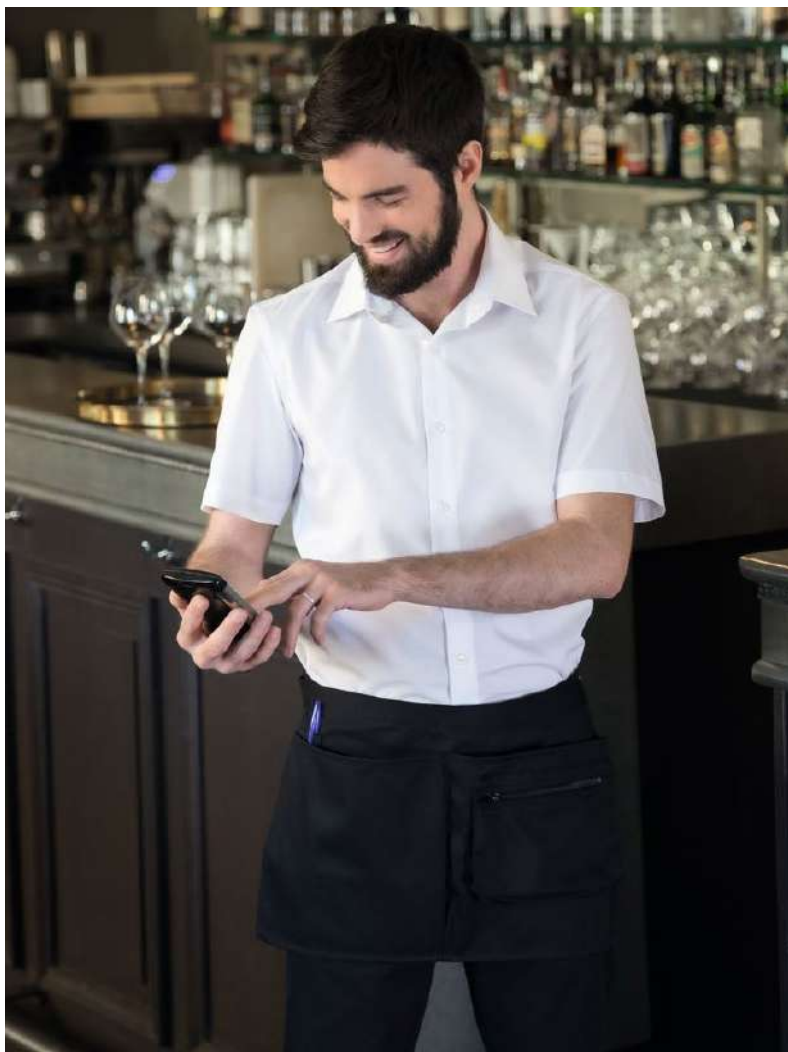

Songe

Nr kat.	PLN	EUR
● U-SO-B	99,28	-
● U-SO-H	99,28	-
● U-SO-K	99,28	-

Polibawełna 195 g/m² • 3 kieszenie: 1 większa na środku i 2 mniejsze po bokach • Rozcięcie z przodu dla komfortowych ruchów • Dł. paska: 100 cm, wys. 59 cm, szer. 98 cm

Polycotton 195 g/m² • 3 patch pockets: 1 central and 2 side • Neckband with snaps for adjusting • Front middle slit • Fabric belt: 100 cm, Height: 59 cm; Width: 98 cm



Phoenix

Nr kat.	PLN	EUR
● U-PH-B	37,62	-
● U-PH-G	87,78	-
○ U-PH-W	37,62	-

100% Bawełna 245 g/m², kolor szary - Polibawełna • Dł. Paska: 100 cm, wys. 60 cm, szer. 105 cm

100% Cotton 245 g/m², grey colour: Polycotton • Height: 60 cm; Width: 105 cm; Belt length: 100 cm





Bandy

Nr kat.	PLN	EUR
● U-BD-B	67,93	-
● U-BD-G	67,93	-

Polibawełna 195 g/m² • Regulowana
 Polycotton 195 g/m² • Fabric tie for adjusting



Atlanta Hat

Nr kat.	PLN	EUR
● U-AT-A	72,11	-
● U-AT-B	72,11	-

Polibawełna 195 g/m² • Regulowana • Sprzedawane w op. po 2 sztuki, w cenie: 45,00 zł • Wys. 8 cm
 Polycotton 195 g/m² • Fabric tie for adjusting • Sold as a set of 2 for 45,00 PLN • H: 8 cm



Athenes

Nr kat.	PLN	EUR
● U-AH-B	62,70	-
● U-AH-A	62,70	-

Polibawełna 195 g/m² • Wymiary: 105x46 cm • Sprzedawane w op. po 2 sztuki, w cenie: 88,00 zł
 Polycotton 195 g/m² • Dim: 105x46 cm • Sold as a set of 2 for 88,00 PLN



Czapka kucharska Cookhat Cook hat

Nr kat.	PLN	EUR
○ U-CH	6,69	-

Wiskoza • Regulowana • Wys: 25 cm
 Viscose • Adjustable • H: 25 cm



Czapka kucharska Premium Cook hat Premium

Nr kat.	PLN	EUR
○ T-147-450	2,76	-

Taśma mocująca, regulowana • Wzór nadrukowany • Bez topu • 50 szt. w opakowaniu, karton zbiorczy: 50 op. • Wys: 22 cm
 Adjusting band • Fake, printed pleats • Open top • Package contains 5 pcs. • H: 22 cm



Rękawiczki kelnerskie Waiter's gloves

Nr kat.	rozmiary	PLN	EUR
○ U-AN-K	S/M	27,17	-
○ U-AN-M	L/XL	27,17	-

100% Bawełna • Cena za parę
 100% Cotton • Price for the pair of 2



TOMGAST

Produkty oznaczone marką TOM-GAST to starannie wyselekcjonowana, spełniająca najostrzejsze kryteria jakościowe, gama produktów dla profesjonalnej gastronomii. Dzięki wieloletniemu doświadczeniu firmy TOM-GAST powstała seria garnków premium, tłoczonych z jednego kawałka najlepszej jakości stali nierdzewnej 18/10.

Products marked with the TOM-GAST brand logo are carefully selected, meeting the strictest quality criteria for products for professional gastronomy. Thanks to many years of experience, the TOM-GAST brand has created a range of premium pots pressed from one piece of the best quality 18/10 stainless steel.

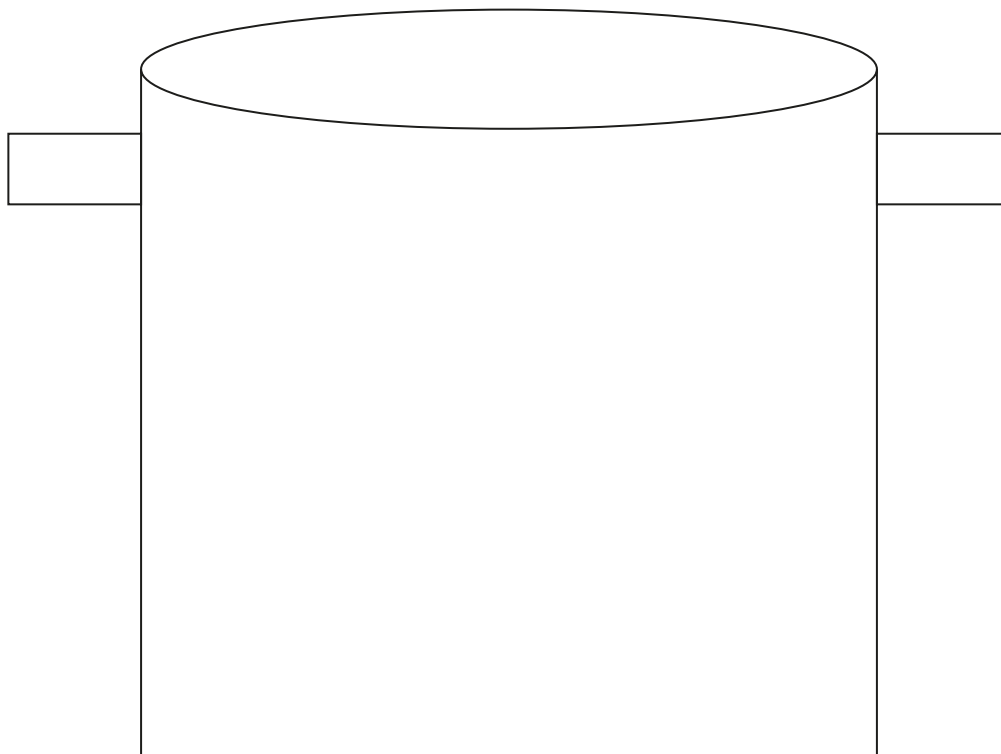

solidność i komfort użytkowania

Garnki Tom-Gast posiadają **grubość ścianki od 1 mm do 1,2 mm**, a w części polerowanej 1,32 mm. Można je stosować również na indukcji oraz nadają się do mycia w zmywarce.

solidity and comfort of use: Tom-Gast pots have a **wall thickness of 1-1.2 mm** and in the polished part 1,32 mm. They are suitable for induction cooking and can be washed in industrial dishwashers.

Wysokopolerowana stal w garnkach Tom-Gast Exclusive, nadaje im eleganckiego charakteru i sprawdzi się świetnie w przestrzeni „open kitchen”. Gładka powierzchnia jest łatwa w utrzymaniu czystości. Uchwyty zgrzewane w 10 punktach. Wielowarstwowe dno o grubości 7 mm perfekcyjnie przewodzi ciepło.

Tom-Gast Exclusive pots have a polished finish. They have an ergonomic handle, welded without rivets in 10 points and a high-gloss lid with a recess under the handle. The 7 mm thick multi-layer bottom ensures good heat transfer.



EXCLUSIVE



Garnek wysoki EXCLUSIVE; 18/10
Stock pot EXCLUSIVE; 18/10

Nr kat.	Ø cm	h cm	cap l	PLN	EUR
P3-2101-16	16	14	2,8	114,75	-
P3-2101-20	20	17	5	166,30	-
P3-2101-24	24	20	8,5	220,99	-
P3-2101-28	28	24	14	323,63	-
P3-2101-32	32	27	20,5	464,96	-



Garnek średni EXCLUSIVE; 18/10
Medium stock pot EXCLUSIVE; 18/10

Nr kat.	Ø cm	h cm	cap l	PLN	EUR
P3-2107-16	16	11	2,2	102,10	-
P3-2107-20	20	12,5	4	145,30	-
P3-2107-24	24	15	6,5	187,21	-
P3-2107-28	28	17	10	259,80	-
P3-2107-32	32	19,5	14	374,36	-



Garnek niski EXCLUSIVE; 18/10
Deep casserole pot EXCLUSIVE; 18/10

Nr kat.	Ø cm	h cm	cap l	PLN	EUR
P3-2109-16	16	7	1,4	115,13	-
P3-2109-20	20	9	2,5	125,10	-
P3-2109-24	24	10,5	4,5	169,91	-
P3-2109-28	28	12	7	232,95	-
P3-2109-32	32	13	10	336,20	-



Rondel EXCLUSIVE; 18/10
Saucepan EXCLUSIVE; 18/10

Nr kat.	Ø cm	h cm	cap l	PLN	EUR
P3-2108-13	13	5	0,7	98,90	-
P3-2108-16	16	7,5	1,4	99,89	-
P3-2108-20	20	9	2,6	145,67	-
P3-2108-24	24	10,5	4,4	195,76	-
P3-2108-28	28	12,5	7	242,47	-



Rondel głęboki EXCLUSIVE; 18/10
Deep saucepan EXCLUSIVE; 18/10

Nr kat.	Ø cm	h cm	cap l	PLN	EUR
P3-2105-16	16	11	2,2	122,38	-
P3-2105-20	20	13	4	161,98	-
P3-2105-24	24	15,5	6,5	205,42	-
P3-2105-28	28	17,5	10	269,00	-



KUP ON-LINE



POKRYWKA | LID

Pokrywka pasuje do garnków linii EXCLUSIVE
Lid fits both EXCLUSIVE and lines pots



Pokrywka EXCLUSIVE; 18/10
Lid EXCLUSIVE; 18/10

Nr kat.	Ø cm	PLN	EUR
P2-2161-16	16	33,00	-
P2-2161-20	20	39,70	-
P2-2161-24	24	54,29	-
P2-2161-28	28	64,67	-
P2-2161-32	32	83,17	-



PRO



Garnek wysoki z pokrywką PRO; 18/10
Stock pot with lid PRO; 18/10

Nr kat.	Ø cm	h cm	cap l	PLN	EUR
P1-2101-16L	16	14	2,8	119,95	-
P1-2101-20L	20	17	5	169,43	-
P1-2101-24L	24	20	8,5	220,15	-
P1-2101-28L	28	24	14	314,85	-
P1-2101-32L	32	27	20,5	427,19	-
P1-2101-36L	36	36	35,5	600,86	-
P1-2101-40L	40	40	50	773,14	-
P1-2101-45L	45	45	65	1 023,14	-
P1-2101-50L	48	43	75,5	1 145,40	-
P1-2105-50L	53	48	100	1 332,50	-



Garnek średni z pokrywką PRO; 18/10
Medium stock pot with lid PRO; 18/10

Nr kat.	Ø cm	h cm	cap l	PLN	EUR
P1-2107-16L	16	11	2,2	110,00	-
P1-2107-20L	20	12,5	4	142,54	-
P1-2107-24L	24	15	6,5	191,18	-
P1-2107-28L	28	17	10	254,06	-
P1-2107-32L	32	19,5	14	359,82	-
P1-2107-36L	36	23	23	454,10	-
P1-2107-40L	40	25	31	604,50	-
P1-2107-45L	45	28	42,5	799,10	-



Garnek niski z pokrywą PRO; 18/10
Shallow casserole with lid PRO; 18/10

Nr kat.	Ø cm	h cm	cap l	PLN	EUR
P1-2109-20L	20	9	2,5	132,10	-
P1-2109-24L	24	10,5	4,5	183,68	-
P1-2109-28L	28	12	7	234,34	-
P1-2109-32L	32	13	10	329,32	-
P1-2109-36L	36	14	14	423,17	-
P1-2109-40L	40	16	20	551,89	-



Garnek płytki z pokrywą PRO; 18/10
Shallow casserole with lid PRO; 18/10

Nr kat.	Ø cm	h cm	cap l	PLN	EUR
P1-2110-32L	32	7,5	6	301,01	-
P1-2110-36L	36	8	8	372,34	-
P1-2110-40L	40	8	10	470,83	-
P1-2110-45L	44	11	16	608,80	-
P1-2110-50L	48	12,5	22	718,73	-



PRO



Garnek wysoki PRO; 18/10
Deep stock pot PRO; 18/10

Nr kat.	Ø cm	h cm	cap l	PLN	EUR
P1-2101-16	16	14	2,8	100,80	-
P1-2101-20	20	17	5	153,94	-
P1-2101-24	24	20	8,5	195,37	-
P1-2101-28	28	24	14	282,40	-
P1-2101-32	32	27	20,5	384,09	-
P1-2101-36	36	36	35,5	550,15	-
P1-2101-40	40	40	50	714,31	-
P1-2101-45	45	45	65	953,04	-
P1-2101-50	48	43	75,5	1 063,15	-
P1-2105-50	53	48,5	100	1 234,15	-



Garnek średni PRO; 18/10
Medium stock pot PRO; 18/10

Nr kat.	Ø cm	h cm	cap l	PLN	EUR
P1-2107-16	16	11	2,2	94,32	-
P1-2107-20	20	12,5	4	126,35	-
P1-2107-24	24	15	6,5	165,28	-
P1-2107-28	28	17	10	225,92	-
P1-2107-32	32	19,5	14	325,53	-
P1-2107-36	36	23	23	400,30	-
P1-2107-40	40	25	31	551,15	-
P1-2107-45	45	28	42,5	729,32	-



Garnek niski PRO; 18/10
Shallow casserole PRO; 18/10

Nr kat.	Ø cm	h cm	cap l	PLN	EUR
P1-2109-20	20	9	2,5	114,31	-
P1-2109-24	24	10,5	4,5	155,40	-
P1-2109-28	28	12	7	199,98	-
P1-2109-32	32	13	10	292,35	-
P1-2109-36	36	14	14	357,05	-
P1-2109-40	40	16	20	490,26	-



Garnek płytki PRO; 18/10
Shallow Casserole PRO; 18/10

Nr kat.	Ø cm	h cm	cap l	PLN	EUR
P1-2110-32	32	7,5	6	246,96	-
P1-2110-36	36	8	8	306,22	-
P1-2110-40	40	8	10	392,17	-
P1-2110-45	44	11	16	512,47	-
P1-2110-50	48	12,5	22	607,10	-



Garnek z kranem i pokrywką; 18/10
Pot with tap and lid; 18/10

Nr kat.	Ø cm	h cm	cap l	PLN	EUR	
P1-2111-40		40	40	50	1 026,71	-
P1-2111-001	kranik zapasowy				173,61	-
P1-2112-40	wkładka do gotowania ziemniaków	40	35		304,00	-

W komplecie z pokrywką • Kranik ze stali nierdzewnej 18/10 • Informacja o gwarancji dotyczy tylko granka

Pot & Lid set • 18/10 stainless steel tap • Guarantee information refers only to the pot



Pokrywka PRO; 18/10
Lid PRO; 18/10

Nr kat.	Ø cm	PLN	EUR
P1-2161-16	16	25,78	-
P1-2161-20	20	30,00	-
P1-2161-24	24	41,10	-
P1-2161-28	28	51,89	-
P1-2161-32	32	75,68	-
P1-2161-36	36	95,87	-
P1-2161-40	40	117,99	-
P1-2161-45	45	134,86	-
P1-2161-50	48	156,28	-
P1-2165-50	53	167,94	-

Pasuje do wszystkich garnków, patelni i rondli marki TOM-GAST®

Fits all TOM-GAST® stockpots, frypans and saucepans



PRO



Rondel głęboki PRO; 18/10
Deep sauce pan PRO; 18/10

Nr kat.	Ø cm	h cm	cap l	PLN	EUR
P1-2105-16	16	11	2,2	103,50	-
P1-2105-20	20	13	4	133,11	-
P1-2105-24	24	15	6,5	182,10	-
P1-2105-28	28	17	10	241,43	-



Rondel PRO; 18/10
Sauce pan PRO; 18/10

Nr kat.	Ø cm	h cm	cap l	PLN	EUR
P1-2108-13	13	5	0,7	77,43	-
P1-2108-16	16	7,5	1,3	88,50	-
P1-2108-20	20	9	2,6	124,32	-
P1-2108-24	24	10,5	4,5	173,79	-
P1-2108-28	28	12,5	7	229,00	-



5-warstwowa konstrukcja
5-layer construction



de Buyer

Rondel wielowarstwowy Affinity; 18/10, Al.
Saucepan Affinity; 18/10, Al.



Nr kat.	Ø cm	l cm	h cm	cap l	PLN	EUR
D-3706-16	13 / 16	33	8	1,8	466,96	-
D-3706-20	17 / 20	39	10	3,4	592,42	-

Skrócony czas gotowania dzięki doskonałemu przewodzeniu ciepła wielowarstwowej stali (stal 18/10 na zewnątrz, aluminium wewnątrz) • Nitowany, ergonomiczny, nienagrzewający się uchwyt • Taka sama grubość ścianek i dna 2,3 mm dla równomiernego rozprowadzania ciepła - potrawy nie przypalają się i nagrzewają się tak samo w każdym punkcie garnka

Combination of stainless steel on the outside and aluminium on the inside - hyper reactive material: very rapide increase in temperature; cooking immediatelly, stops when off the heat • Uniform diffusion of heat on the entire skirt and perfect heat distribution: even cooking, ideal for reduction cooking, sauces • Riveted, ergonomic, low temperature guaranteed handle



de Buyer

Rondel; miedź, 18/10
Saucepan; copper, 18/10

Nr kat.	Ø cm	h cm	cap ml	thk mm	PLN	EUR
D-6453-09	9	4,8	300	1	463,48	-



TOMGAST



Rondel konikalny PRO; 18/10
Conical saute pan PRO; 18/10

Nr kat.	Ø cm	h cm	cap l	PLN	EUR
P1-2104-16	16	6	1	93,00	-
P1-2104-20	20	7	1,5	132,20	-
P1-2104-24	24	7,5	2,8	145,20	-



de Buyer

CHOC
CLASSIC

Rondel konikalny Choc; Al/non-stick
Conical saute pan Choc; Al, non-stick

Nr kat.	Ø cm	l cm	h cm	PLN	EUR
D-8188-20	20	35,8	6,5	151,70	-
D-8188-24	24	43	6,5	188,10	-



de Buyer

Garnek z płaszczem wodnym; 18/10
Bain-mare cooker; 18/10

Nr kat.	Ø cm	h cm	cap l	thk mm	PLN	EUR
D-3437-16	16	12,5	1,5	5	234,95	-

Podwójne ścianki, pomiędzy którymi podgrzewana jest woda • Doskonale nadaje się do topienia czekolady oraz podgrzewania sosów

Hollow stainless steel in which water is heated • Best for melting chocolate or keeping sauces warm



Garnek do gotowania szparagów; 18/10
Asparagus steamer pot; 18/10

Nr kat.	Ø cm	h cm	cap l	PLN	EUR
T-6660	16	23,5	4,5	256,50	-

W zestawie pokrywa i wkład

With lid and basket insert



Wkładka do gotowania makaronu; 18/10
Pasta/steamer basket; 18/10

Nr kat.	→ □	h cm	PLN	EUR
T-1406-360	P1-2107-36	23	220,88	-
T-1406-400	P1-2107-40	26	266,00	-

Śr. otworów 3,5 mm • Z haczykiem do zawieszania na brzegu garnka

Diameter of holes 3,5 mm • With hook to hang it on the edge of the pot

TOMGAST



Sito bambusowe
Bamboo steamer

Nr kat.	Ø cm	PLN	EUR
V-30060	15	36,05	-
V-30061	20	45,46	-

produkt zawiera 3 elementy: 2 podstawy i 1 pokrywę

product contains 3 elements: 2 base baskets and 1 lid





3-warstwowa konstrukcja
3-layer construction

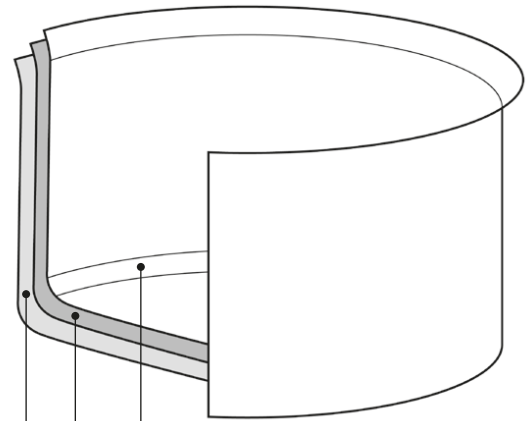

Wnętrze ze stali nierdzewnej 18/10
Stainless steel 18/10 inside

Aluminium
Aluminium

INOX INDUCTION Powłoka indukcyjna ze stali
nierdzewnej 18/10
INOX INDUCTION Stainless steel 18/10 outside

ALCHIMY

Kolekcja **ALCHIMY** została stworzona, aby uhonorować stulecie współpracy de Buyer i szefów kuchni. Zaprojektowane z największą dbałością, aby sprostać wymaganiom profesjonalnych kucharzy.



można używać
w piekarniku

*The **ALCHIMY** collection has been created to honor & celebrate a 100 year collaboration between de Buyer and CHEFs around the world. Designed with attention to detail to meet professional's demands.*

- wykonana ze stali nierdzewnej łatwej do czyszczenia, nietoksycznej i wytrzymałej
- wielowarstwowa konstrukcja gwarantuje równomierne rozprzowanie ciepła i kontrolę temperatury
- miarka wewnątrz
- ergonomiczne, solidnie nitowane uchwyty zapewniają wieloletnią trwałość i komfort użytkowania.
- eleganckie szczotkowane wykończenie
- można stosować na każdym rodzaju płyt grzewczych
- inner layer stainless steel 18/10, easy to clean, non-toxic and durable
- stainless steel 3-ply construction guarantees uniform temperature distribution and heat control
- capacity marks
- stay-cool handle with rock-solid riveted attachment
- brushed finish
- all heat sources including induction and oven





Garnek Alchimy; stal nierdzewna
Alchimy Pot; SS

Nr kat.	Ø cm	h cm	cap l	thk mm	PLN	EUR
D-3605-16	13/16	8,6	1,5	2,3	416,90	-
D-3605-20	15,4/20	9,6	2,5	2,3	492,14	-
D-3605-24	21/24	12,4	5	2,3	570,80	-
D-3605-28	24,5/28	14,8	7	2,3	707,94	-



Patelnia Alchimy; stal nierdzewna
Alchimy frying pan; SS

Nr kat.	Ø cm	l cm	h cm	thk mm	PLN	EUR
D-3604-20	13,5/20	36,5	3,3	2,3	396,84	-
D-3604-24	17/24	46,5	4,6	2,3	386,12	-
D-3604-28	20/28	51	4,8	2,3	423,74	-
D-3604-32	23/32	56	5	2,3	498,98	-



Rondel niski Alchimy; stal nierdzewna
Alchimy saucepan; SS

Nr kat.	Ø cm	l cm	h cm	cap l	thk mm	PLN	EUR
D-3602-24	20,5/24	49	7,3	3	2,3	498,98	-
D-3602-28	24,5/28	51	8,6	4,6	2,3	668,22	-



Rondel Alchimy; stal nierdzewna
Alchimy saucepan; SS

Nr kat.	Ø cm	l cm	h cm	cap l	thk mm	PLN	EUR
D-3601-14	11/14	31	7,5	1	2,3	396,84	-
D-3601-16	13/16	31	8,6	1,5	2,3	440,10	-
D-3601-20	15,5/20	39,5	8,7	2,5	2,3	530,56	-



Rondel konikalny Alchimy; stal nierdzewna
Alchimy Conical saute pan; SS

Nr kat.	Ø cm	l cm	h cm	cap l	thk mm	PLN	EUR
D-3603-24	17/24	47	7,4	2,5	2,3	530,56	-



KUP ON-LINE



De Buyer to francuska marka z ponad 180-letnim doświadczeniem, ceniąca tradycję, a zarazem nowoczesne rozwiązania. Produkuje naczynia do gotowania i pieczenia o niezwykłej jakości, takie jak patelnie do smażenia mięs i ryb, woki, misy, garnki, a także artykuły cukiernicze.

De Buyer is a French brand with over 180 years of experience, valuing tradition and modern solutions. It produces cooking and baking utensils of unusual quality, such as frying pans for meat and fish, woks, bowls, pots, and confectionery.

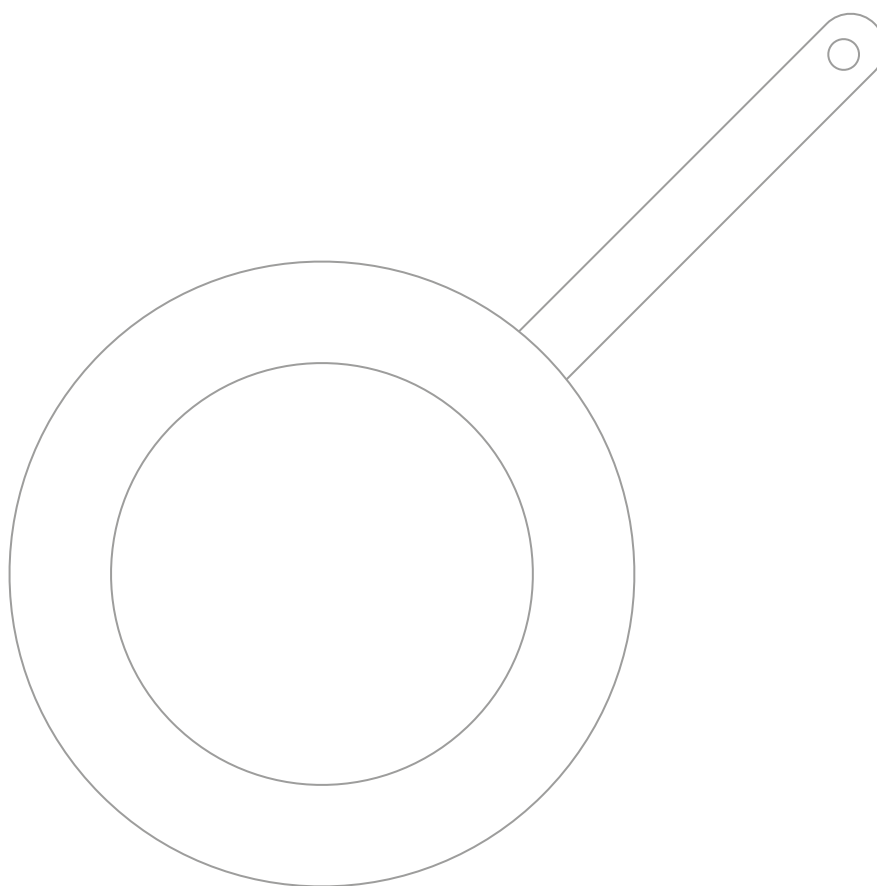

Profesjonalne patelnie: ze stali węglowej - do smażenia w wysokich temperaturach, a także non-stick, pokrytych wysokiej jakości powłoką zapobiegającą przywieraniu dania. Doskonale rozprawdzają ciepło.

De Buyer's professional pans are divided into steel pans and pans with a non-stick coating. They perfectly distribute heat.

Wysokowęglowe patelnie stalowe de Buyer są dedykowane do smażenia mięs w wysokich temperaturach, by stało się ono chrupkie na zewnątrz, a pozostało soczyste wewnątrz.

De Buyer has in its offer an excellent selection of steel pan, thanks to which the fried meat immediately caramelizes on the outside and remains juicy inside.



PATELNIĘ STALOWE:

**Carbono Plus**

Stal węglowa
gr.: 2,5 do 3 mm
indukcja: TAK
zmywarka: NIE

**Lyonnaisse**

Stal niebieska
gr.: 1 do 1,5 mm
indukcja: NIE
zmywarka: NIE

**#OUTDOOR**

Stal niebieska
gr.: 2 mm
indukcja: TAK
zmywarka: NIE

**ALCHIMY**

Stal nierdz. / Al
gr.: 2,7 mm
indukcja: TAK
zmywarka: TAK

**TOMGAST**

Stal nierdzewna
gr.: 1-1,5 mm; dno 7mm
indukcja: TAK
zmywarka: TAK

PATELNIĘ ŻELIWNE

**Żeliwo**

indukcja: TAK
zmywarka: NIE

PATELNIĘ Z POWŁOKĄ NON-STICK:

**CHOC CLASSIC**

Aluminium
gr.: 4 do 5 mm
pokrycie: PTFE
indukcja: NIE
zmywarka: NIE

**CHOC ACCESS**

Aluminium
gr.: 4 mm
pokrycie: PTFE
indukcja: NIE
zmywarka: NIE

**CHOC RESTO INDUCTION**

Aluminium
gr.: 5 mm
pokrycie: PTFE
indukcja: TAK
zmywarka: NIE

**CHOC EXTRÊME**

Aluminium
gr.: 3 do 8 mm
pokrycie: wys. jakości PTFE
indukcja: TAK
zmywarka: NIE

**TOMGAST**

Stal 18/10
gr.: 1 mm; dno 7 mm
pokrycie: powłoka non-stick
indukcja: TAK
zmywarka: NIE

**TOMGAST**

Stal 18/10
gr.: 1-1,5 mm; dno 7 mm
pokrycie: powłoka non-stick
indukcja: TAK
zmywarka: NIE

KONSERWACJA PATELNI:



PATELNIĘ Z POWŁOKĄ NON-STICK

CHOC CLASSIC**CHOC RESTO INDUCTION****CHOC EXTRÊME****CHOC ACCESS****TOMGAST**

Przed zanurzeniem w wodzie należy odczekać aż patelnia ostygnie • Stosować miękką ściereczkę oraz gąbkę • Patelnię nagrzewaj tylko wtedy, gdy jest na niej tłuszcz lub potrawa • Do mieszania potraw używaj łypek z tworzywa lub drewna

PATELNIĘ ZE STALI WĘGLOWEJ I NIEBIESKIEJ

Carbono Plus**Lyonnaisse****#OUTDOOR**

Sezonowanie patelni przed pierwszym użyciem:

Krok 1



Zalej patelnię cienką warstwą oleju.

Krok 2



Smaż olej aż do pojawienia się dymu, po czym ściągaj olej i wytrzyj patelnię papierowym ręcznikiem

WYGLĄD PATELNI PRZED I PO PIERWSZYM SEZONOWANIU:

SEZONOWANA



NOWA

Myj patelnię w gorącej wodzie • Nie namaczaj zbyt długo i nie używaj ostrej ściereczki - doskonale sprawdzi się grubo ziarnista sól • Po zakończeniu smażenia wypłucz i wytrzyj do sucha • Nasmaruj patelnię kilkoma kroplami oleju • Nie myj patelni w zmywarce • Stalowa patelnia po długim użytkowaniu staje się czarna, co oznacza że wytworzyła się na niej warstwa węglowej patyny odpowiedzialnej za nieprzywieranie do patelni smażonych produktów • Jeżeli na patelni pojawi się rdzawy nalot, zetrzyj go szczotką • Po zakupie natłuszc patelnię aby zabezpieczyć ją przed korozją



STEEL PANS:



CarbonePlus

Carbon steel
thk: 2,5 to 3 mm
induction: YES
dishwasher: NO



La Lyonnaise

Blue steel
thk: 1 to 1,5 mm
induction: NO
dishwasher: NO



#OUTDOOR

Blue steel
thk: 2 mm
induction: YES
dishwasher: NO



ALCHIMY

SS / Aluminium
thk: 2,7 mm
induction: YES
dishwasher: YES



TOMGAST

Stainless steel
thk: 1-1,5 mm; bottom 7mm
induction: YES
dishwasher: YES

CAST IRON PANS:



Cast iron

induction: YES
dishwasher: NO

NON-STICK PANS:



CHOC CLASSIC

Aluminium
thk: 4 to 5 mm
covering: PTFE
induction: NO
dishwasher: NO



CHOC ACCESS

Aluminium
thk: 4 mm
covering: PTFE
induction: NO
dishwasher: NO



CHOC RESTO INDUCTION

Aluminium
thk: 5 mm
covering: high q PTFE
induction: YES
dishwasher: NO



CHOC EXTRÊME

Aluminium
thk: 3 do 8 mm
covering: high q PTFE
induction: YES
dishwasher: NO



TOMGAST

Stainless steel 18/10
thk: 1 mm; bottom 7 mm
covering: non-stick
induction: YES
dishwasher: NO



TOMGAST

Stainless steel 18/10
thk: 1-1,5 mm; bottom 7 mm
covering: non-stick
induction: YES
dishwasher: NO

TIPS AND MAINTENANCE:



NON-STICK PANS

CHOC CLASSIC

CHOC RESTO INDUCTION

CHOC EXTRÊME

CHOC ACCESS

TOMGAST

Before immersing in water, allow the pan to cool down • Clean/use with a soft cloth or sponge • Do not heat the pan without fat or food • Use plastic or wooden spatulas to mix dishes

CARBON AND BLUE STEEL PANS

CarbonePlus

La Lyonnaise

#OUTDOOR

Seasoning a pan before first use:

Step 1



Coat the base of the pan with a thin layer of oil

Step 2



Heat the oil until smoke appears, then remove the pan from fire, pour off the oil and wipe the pan with a paper towel

THE APPEARANCE OF THE PAN BEFORE AND AFTER THE FIRST SEASONING



SEASONED

NEW

Wash the pan with hot water • Do not soak for too long and do not use a coarse cloth - a coarse salt will work well • After cooking, rinse and wipe dry • Coat the pan with a few drops of oil • Do not wash the pan in the dishwasher • The steel frying pan becomes dark after long use, which means that a layer of carbon patina, which is responsible for not sticking fried products to the pan, has been formed on it. • If a rusty coating appears on the pan, wipe it with a brush • After purchase, grease the pan to protect it from corrosion





La Lyonnaise

max. 10 min
max. 200° C

Patelnia La Lyonnaise; stal niebieska
Frying pan La Lyonnaise; blue steel

Nr kat.	Ø cm	l cm	h cm	thk mm	PLN	EUR
D-5020-14	9/14	26,2	3,3	1	45,79	-
D-5020-18	13/18	34,9	3,6	1	64,11	-
D-5020-20	14/20	36,9	4	1	63,41	-
D-5020-24	17/24	41,2	4,5	1	73,97	-
D-5020-28	20/28	49,3	4,7	1,2	104,27	-
D-5020-32	24/32	55,5	5,5	1,2	118,36	-
D-5020-36	27/36	65,8	6	1,5	162,04	-
D-5020-40	30/40	69,1	6,5	1,5	187,05	-
D-5020-45	34/45	83,2	7,5	1,5	250,10	-

Szybkie zamykanie porów w mięsie i karmelizacja jego soków • Wysokie, zaokrąglone ścianki • Lekka • Sezonowanie przed pierwszym użyciem nadaje właściwości non-stick - instrukcja str. 33

Quick caramelizing the meat juices • High flared and curved skirt and no sharp angles enables the food easily slide from a pan • Light • Seasoning, adding non-stick property, before the first use is needed - manual p.34



Carbon:Plus

max. 10 min
max. 200° C

Patelnia Carbon; stal węglowa
Frying pan Carbon; carbon steel

Nr kat.	Ø cm	l cm	h cm	thk mm	PLN	EUR
D-5110-20	14/20	36,8	3,2	2,5	114,13	-
D-5110-24	17,5/24	44	3,5	2,5	133,16	-
D-5110-28	20/28	50,5	4	3	172,96	-
D-5110-32	23/32	60	4,5	3	212,42	-
D-5110-36	26/36	69,5	4,5	3	262,08	-
D-5110-40	30/40	73	5,3	3	321,97	-

Szybkie zamykanie porów w mięsie i karmelizacja jego soków • Optymalnie zaprojektowany rant ułatwiający zsuniecie potrawy na talerz • Patelnie Ø 32, 36, 40 posiadają dodatkowy uchwyt • Sezonowanie przed pierwszym użyciem nadaje właściwości non-stick - instrukcja str. 33

Quick caramelizing the meat juices • Shape with soft angles enables the food easily slide from a pan • Ø size: 32, 36 and 40 pans come with an additional handle • Seasoning, adding non-stick property, before the first use is needed - manual p.34



Carbon:Plus

max. 10 min
max. 200° C

Patelnia grillowa Carbon; stal węglowa
Grill frying pan Carbon; carbon steel

Nr kat.	Ø cm	l cm	h cm	thk mm	PLN	EUR
D-5530-26	18,5/26	48	4,3	2	146,54	-
D-5530-30	21,5/30	54	4,5	2	193,04	-

Świetna do pracy w wysokiej temperaturze • Szybkie zamykanie porów w mięsie i karmelizacja jego soków • Sezonowanie przed pierwszym użyciem nadaje właściwości non-stick - instrukcja str. 33

Ideal for working long on high temperature • Quick caramelizing the meat juices • Seasoning, adding non-stick property, before the first use is needed - manual p. 34



Carbon:Plus

max. 10 min
max. 200° C

Patelnia Carbon z wentylowanym uchwytem; stal węglowa
Frying pan with cold handle Carbon; carbon steel

Nr kat.	Ø cm	l cm	h cm	thk mm	PLN	EUR
D-5130-20	14/20	36,6	3,2	2,5	135,62	-
D-5130-24	17,5/24	43,7	3,5	2,5	158,52	-
D-5130-28	20/28	51	4	3	202,55	-
D-5130-32	23/32	59,6	4,5	3	257,15	-

Szybkie zamykanie porów w mięsie i karmelizacja jego soków • Optymalnie zaprojektowany rant ułatwiający zsuniecie potrawy na talerz • Ergonomiczny, nienagrzewający się uchwyt ze stali nierdzewnej • Sezonowanie przed pierwszym użyciem nadaje właściwości non-stick - instrukcja str. 33

Quick caramelizing the meat juices • Shape with soft angles enables the food easily slide from a pan • Seasoning, adding non-stick property, before the first use is needed - manual p. 34



MINERAL B

max. 10 min
max. 200° C

Patelnia do steków Mineral B; stal węglowa
Steak frying pan Mineral B; carbon steel

Nr kat.	Ø cm	l cm	h cm	thk mm	PLN	EUR
D-5616-24	18/24	44	3,8	2,5	178,34	-
D-5616-28	21,3/28	51	4	2,5	249,92	-

Idealna do smażenia steków • Pokrywa mięso wzorem kratki podczas smażenia • Sezonowanie przed pierwszym użyciem nadaje właściwości non-stick - instrukcja str. 33

Ideal for frying steaks • The ribbed base marks the meat • Seasoning, adding non-stick property, before the first use is needed - manual p.34



Carbon:Plus

max. 10 min
max. 200° C

Patelnia owalna Carbon; stal węglowa
Frying pan carbon oval; carbon steel

Nr kat.	l cm	h cm	w cm	thk mm	PLN	EUR
D-5131-36	50,3	4,6	26	2,5	249,32	-

Idealna do smażenia ryb w całości • Nitowana rękojść • Sezonowanie przed pierwszym użyciem nadaje właściwości non-stick - instrukcja str. 33

Ideal for frying fish whole • Riveted handle • Seasoning, adding non-stick property, before the first use is needed - manual p.34



Carbon:Plus

max. 10 min
max. 200° C

Patelnia grillowa prostokątna Carbon; stal węglowa
Grill frying pan rectangular Carbon; carbon steel

Nr kat.	l cm	w cm	thk mm	PLN	EUR
D-5540-38	38	26	2,5	354,02	-

Świetna do pracy w wysokiej temperaturze • Szybkie zamykanie porów w mięsie i karmelizacja jego soków • Sezonowanie przed pierwszym użyciem nadaje właściwości non-stick - instrukcja str. 33

Ideal for working long on high temperature • Quick caramelizing the meat juices • Seasoning, adding non-stick property, before the first use is needed - manual p.34





Patelnia grillowa; żeliwo
Grill frying pan; cast iron

Nr kat.	Ø cm	PLN	EUR
T-120710	28	442,49	-

Świetna do pracy w wysokiej temperaturze • Szybkie zamykanie porów w mięsie i karmelizacja jego soków

Ideal for working long on high temperature • Quick caramelizing the meat juices



Patelnia; żeliwo
Frying pan; cast iron

Nr kat.	Ø cm	PLN	EUR
T-112410	25	332,24	-
T-112810	28	402,44	-

Świetna do pracy w wysokiej temperaturze • Szybkie zamykanie porów w mięsie i karmelizacja jego soków

Ideal for working long on high temperature • Quick caramelizing the meat juices



Patelnia grillowa prostokątna; żeliwo
Grill frying pan rectangular; cast iron

Nr kat.	l cm	w cm	PLN	EUR
T-152300	23	23	230,39	-

Świetna do pracy w wysokiej temperaturze • Szybkie zamykanie porów w mięsie i karmelizacja jego soków

Ideal for working long on high temperature • Quick caramelizing the meat juices



de Buyer

TOMGAST

TOMGAST

Patelnia Alchimy; stal nierdzewna
Alchimy frying pan; SS

Nr kat.	Ø cm	l cm	h cm	thkmm	PLN	EUR
D-3604-20	13,5/20	36,5	3,3	2,3	396,84	-
D-3604-24	17/24	46,5	4,6	2,3	386,12	-
D-3604-28	20/28	51	4,8	2,3	423,74	-
D-3604-32	23/32	56	5	2,3	498,98	-



Patelnia Exclusive; 18/10
Frying pan Exclusive; 18/10

Nr kat.	Ø cm	l cm	h cm	PLN	EUR
P3-2103-20	15,5/22	23,6/44,8	5	103,86	-
P3-2103-24	19/26	23,4/48,3	5	137,60	-
P3-2103-28	23/30	28,5/57,6	5,5	182,57	-
P3-2103-32	27/34	31,4/64,6	6	253,49	-

Grube, trójwarstwowe dno „sandwich” • Nienagrzewający się, beznitowo mocowany uchwyt • Doskonała do smażenia na maśle

Thick sandwich bottom • Not heated while cooking, welded stainless steel handles



Patelnia PRO; 18/10
Frying pan PRO; 18/10

Nr kat.	Ø cm	l cm	h cm	PLN	EUR
P1-2103-20	15,5/22	24/44,8	5	94,02	-
P1-2103-24	19/26	23/48,3	5	120,93	-
P1-2103-28	23/30	28,5/57,6	5,5	162,51	-
P1-2103-32	27/34	31,6/64,6	6	233,63	-
P1-2103-36	31/38	34/75,2	6	281,30	-
P1-2103-40	35/42,5	34/79	6,5	349,87	-

Grube, trójwarstwowe dno „sandwich” • Nienagrzewający się, beznitowo mocowany uchwyt • Doskonała do smażenia na maśle

Thick sandwich bottom • Not heated while cooking, welded stainless steel handles



TOMGAST

Patelnia PRO; 18/10, non-stick
Frying pan PRO; 18/10, non-stick

Nr kat.	Ø cm	l cm	h cm	PLN	EUR
N P1-2102-20	15,5/22	24/44,8	5	158,24	-
P1-2102-24	19/26	28,5/57	5	208,40	-
P1-2102-28	23/30	28,7/58	5,5	280,84	-
P1-2102-32	27/34	29/61,7	6	358,60	-

Grube, trójwarstwowe dno „sandwich” • Nienagrzewający się, beznitowo mocowany uchwyt

Thick sandwich bottom • Not heated while cooking, welded stainless steel handles



TOMGAST

Patelnia Granite EXCLUSIVE; 18/10, non-stick
Frying pan Granite EXCLUSIVE; 18/10, non-stick

Nr kat.	Ø cm	l cm	h cm	PLN	EUR
N P1-2106-20	15,5/22	23,6/44,8	5	158,24	-
P1-2106-24	19/26	23,6/49	5	209,92	-
P1-2106-28	23/30	28,6/57,6	5,5	276,70	-
P1-2106-32	27/34	29/61,5	6	362,70	-

Wzmocniona powłoka non-stick o charakterystycznej marmurkowej teksturze • Wysokopolerowana stal nierdzewna • Grube, trzywarstwowe dno typu sandwich. • Wentylowany, mocowany beznitowo uchwyt • Wysokopolerowana stal nierdzewna





CHOC
CLASSIC

PFOA FREE

Patelnia Choc; aluminium, non-stick
Frying pan Choc; Al, non-stick

Nr kat.	Ø cm	l cm	h cm	thkmm	PLN	EUR
D-8140-12	9,5 / 12	24,2	1,5	3,3	75,24	-
D-8140-14	11 / 14	26	1,7	4	85,50	-
D-8180-20	14,2 / 20	36,7	3	4	106,02	-
D-8180-24	17,5 / 24	43,5	3,5	4	131,67	-
D-8180-26	18,8 / 26	48	3,7	4	143,64	-
D-8180-28	21 / 28	50	3,8	4	157,32	-
D-8180-32	23,5 / 32	55,6	4,5	4	181,26	-
D-8180-36	27,5 / 36	66	4,7	5	270,18	-
D-8180-40	30 / 40	70	5,3	5	306,09	-

Optymalnie zaprojektowany rant ułatwiający zsuniecie potrawy na talerz
Shape with soft angles enables the food easily slide from a pan



CHOC
ACCESS

PFOA FREE



Patelnia Choc Access; aluminium, non-stick
Frying pan Choc Access; Al, non-stick

Nr kat.	Ø cm	l cm	h cm	thk mm	PLN	EUR
D-8030-20	20	37	3	3	87,98	-
D-8030-24	24	43,3	3,5	3,3	105,60	-
D-8030-28	28	49,5	4	3,3	125,84	-
D-8030-32	32	55,5	4,5	3,3	137,49	-
D-8030-36	36	65	4,5	4	224,00	-
D-8030-40	40	70	5,2	4	254,69	-

Idealna do odgrzewania, gotowania delikatnych potraw • Nitowany uchwyt zakrzywiony w stylu francuskim • Możliwość zapiekania w piekarniku: 10 min / 200°C

Ideal for reheating, cooking delicate dishes • Riveted French-style curved handle • Oven baking: 10 min / 200°C



CHOC
CLASSIC

PFOA FREE

Patelnia owalna Choc; aluminium, non-stick
Frying pan Choc oval; Al, non-stick

Nr kat.	l cm	h cm	w cm	thk mm	PLN	EUR
D-8181-36	36 / 66	4,3	26	5	319,77	-

Optymalnie zaprojektowany rant ułatwiający zsuniecie potrawy na talerz
Shape with soft angles enables the food easily slide from a pan



CHOC
RESTO
INDUCTION

PFOA FREE

Patelnia Choc Resto Induction; aluminium, non-stick
Frying pan Choc Resto Induction; Al, non-stick

Nr kat.	Ø cm	l cm	h cm	thk mm	PLN	EUR
D-8480-20	13 / 20	36,7	3	5	171,00	-
D-8480-24	16 / 24	43,5	3,5	5	224,01	-
D-8480-28	20 / 28	50	3,8	5	254,79	-
D-8480-32	23 / 32	55,6	4,5	5	302,67	-

Optymalnie zaprojektowany rant ułatwiający zsuniecie potrawy na talerz
Shape with soft angles enables the food easily slide from a pan



- Ekstremalnie odporne na odkształcenia
- Wykonane z grubego aluminium odlewane ciśnieniowo
- Uchwyty z odlewanej stali nierdzewnej
- Idealne do zdrowego gotowania, nawet bez użycia tłuszczu
- Można używać w piecu – do 250°C

- *Extremely resistant to deformation*
- *Made of thick, cast aluminium*
- *A long cast stainless steel handle*
- *Perfect for healthy cooking, even without any fat*
- *Can be used in an oven – up to 250°C*



CHOC
EXTREME

PFOA FREE

Patelnia Choc Extreme; aluminium, non-stick
Frying pan Choc Extreme; Al, non-stick

Nr kat.	Ø cm	l cm	h cm	thk mm	PLN	EUR
D-8310-20	12,5 / 20	40	4,2	3	326,78	-
D-8310-24	16 / 24	45,5	4,2	3	414,89	-
D-8310-28	18,5 / 28	52	4,6	3	509,24	-
D-8310-32	22 / 32	63	4,6	3	557,01	-
D-8310-36	23 / 36	72	4,6	3	607,44	-

Ergonomiczny, nienagrzewający się uchwyt ze stali nierdzewnej • Grubość dna: 8 mm • Ekstremalnie odporne patelnie z odlewane aluminium z zaawansowaną powłoką typu non-stick, która maksymalnie wydłuża jej żywotność

Hollow stainless steel, not heated while cooking handles • Bottom thickness: 8mm • Heavy duty cast aluminium with the highest quality non-stick coating which is consolidated by a PTFE projection





Wok; stal węglowa
Wok; carbon steel

Nr kat.		Ø cm	l cm	h cm	thk mm	PLN	EUR
D-5618-32	Mineral B	32	60,5	9,7	2	263,00	-
D-5114-35	Carbone	35,5	69,5	8,5	1,5	277,36	-
D-5618-40	Mineral B	40	69	10,4	2	273,26	-

Sezonowanie przed pierwszym użyciem nadaje właściwości non-stick - instrukcja str. 33
Seasoning, adding non-stick property, before the first use is needed - manual p. 34



CarbonePlus



Koszyk do głębokiego smażenia;
drot cynowany
Deep fryer basket; tinned wire

Nr kat.	Ø cm	h cm	PLN	EUR
D-5051-32	32	8,7	195,09	-

Gęsty splot
Close-woven



OUTDOOR

Patelnia wysoka Force Blue; stal niebieska
Deep frying pan Force Blue; blue steel

Nr kat.	Ø cm	l cm	h cm	cap l	thk mm	PLN	EUR
D-5414-20	14/20	39,5	7	1,7	2	119,02	-
D-5414-24	17/24	46,5	7,5	2,5	2	140,56	-
D-5414-28	20/28	51,5	8,5	4	2	169,29	-
D-5414-32	dodatkowy uchwyt	22/32	66,5	9	5,5	272,80	-

Szybkie zamykanie porów w mięsie i karmelizacja jego soków • Głębokość ułatwiająca pracę z dużą ilością produktu • Sezonowanie przed pierwszym użyciem nadaje właściwości non-stick - instrukcja str. 33

Quick caramelizing the meat juices • High-sided ideal for large quantities of ingredients, easily reducing juice spat • Seasoning, adding non-stick property, before the first use is needed - manual p. 34



CarbonePlus

Patelnia do paelli Carbone; stal węglowa
Paella frying pan Carbone; carbon steel

Nr kat.	Ø cm	l cm	h cm	thk mm	PLN	EUR
D-5113-32	23,5/32	40	3	3	200,07	-
D-5113-40	30/40	48,5	5	3	309,51	-
D-5113-50	40/50	57	5,7	3	490,77	-

Sezonowanie przed pierwszym użyciem nadaje właściwości non-stick - instrukcja str. 33

Seasoning, adding non-stick property, before the first use is needed - manual p. 34



OUTDOOR

Patelnia do paelli La Lyonnaise; stal niebieska
Paella frying pan La Lyonnaise; blue steel

Nr kat.	Ø cm	l cm	h cm	thk mm	PLN	EUR
D-5026-24	19/24	34,5	3,5	1	39,33	-
D-5026-28	23/28	38,2	4	1	53,35	-

Młotkowane dno • Nie można zapiekać w piekarniku
The hammered bottom • Not suitable for baking in oven



Brytfanna; 18/10
Roasting pan; 18/10

Nr kat.	l cm	h cm	w cm	PLN	EUR
T-1941-40	40	9	26	611,44	-
T-1941-50	50	9	30	813,96	-
T-1948-40	40			276,17	-
T-1948-50	50			412,31	-

Pokrywa do kupienia oddzielnie
Lid sold separately





CHOC
CLASSIC

PFOA FREE



CHOC
RESTO
INDUCTION

PFOA FREE

Patelnia do naleśników Choc; aluminium, non-stick
Pancake pan Choc; Al, non-stick

Nr kat.	Ø cm	l cm	h cm	thk mm	PLN	EUR
D-8185-22	17,5/22	42	1,5	3	94,05	-
D-8185-26	21,5/26	45	1,5	3,3	111,15	-
D-8185-30	25,5/30	54	1,5	3,3	131,67	-

Niskie ścianki i optymalna gładkość pozwalają z łatwością odwrócić naleśnik oraz zsunąć go na talerz • Powłoka non-stick

Low skirt and optimum slip qualities allow pancakes to be easily turned or slid onto a plate



Patelnia do naleśników Choc Resto Induction;
aluminium, non-stick
Pancake pan Choc Resto Induction; Al, non-stick

Nr kat.	Ø cm	l cm	h cm	thk mm	PLN	EUR
D-8485-26	18/26	48	1,5	4	206,91	-
D-8485-30	22/30	58	1,5	4	263,34	-

Niskie ścianki i optymalna gładkość pozwalają z łatwością odwrócić naleśnik oraz zsunąć go na talerz

Low skirt and optimum slip qualities allow pancakes to be easily turned or slid onto a plate



OUTDOOR



Carbon:Plus

Mini patelnia; stal niebieska
Mini frying pan; blue steel

Nr kat.	Ø cm	l cm	h cm	thk mm	PLN	EUR
D-5440-12	9/12	24,1	2	2	50,00	-

Sezonowanie przed pierwszym użyciem nadaje właściwości non-stick - instrukcja str. 33

Seasoning, adding non-stick property, before the first use is needed - manual p. 34



Patelnia do naleśników Carbone; stal węglowa
Pancake pan Carbone; carbone steel

Nr kat.	Ø cm	l cm	h cm	thk mm	PLN	EUR
D-5120-26	22,5/26	48	1,5	2,5	110,12	-
D-5120-30	25,5/30	54	1,7	2,5	140,90	-

Niskie ścianki pozwalają na łatwe przewrócenie naleśnika • Sezonowanie przed pierwszym użyciem nadaje właściwości non-stick - instrukcja str. 33

Low skirt and optimum slip qualities allow pancakes to be easily turned or slid onto a plate • Seasoning, adding non-stick property, before the first use is needed - manual p. 34



Patelnia do jajek sadzonych; żeliwo
Fried eggs pan; cast iron

Nr kat.	Ø cm	Ø o cm	PLN	EUR
T-152100	24	8	201,79	-



Szpatuła do ciasta naleśnikowego; drewno
Crepe dough spreader; wood

Nr kat.	l cm	h cm	w cm	PLN	EUR
D-4873-02	20	3	16	12,65	-



Pierścień do jaj sadzonych; 18/10
Eggs ring; 18/10

Nr kat.	Ø cm	h cm	PLN	EUR
T-2785	8,5	1,5	15,20	-



POJEMNIKI GN – STALOWE | STEEL GN CONTAINERS

- Przygotowanie potraw: podgrzewanie, gotowanie, pieczenie, garowanie w piecach
- Do zastosowania w: podgrzewaczach, ciągach wydawczych, barmach, termoportach, ladach chłodniczych, barach sałatkowych itp.

- Preparation of food: heating, cooking, baking, oven cooking
- Can be used in: preheaters, serving lines, bain maries, thermoports, refrigerated counters, salad bars, etc.



POJEMNIKI TOM-GAST PRIX

- Grubość blachy: 0,6 mm – 0,7 mm
- Wykonane w całości ze stali nierdzewnej 18/10
- Zgodne z normą EN 631
- 2 różne typy pokryw

TOM-GAST PRIX CONTAINERS

- Sheet thickness: 0,6 mm - 0,7 mm
- Made entirely of 18/10 stainless steel
- Compliant with EN 631
- 2 different types of lids

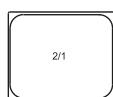

GN 2/1 650 x 530 mm

h cm	cap l	Nr kat.	PLN/EUR
2	5	VL-21020	140,33 / -
4	10	VL-21040	129,29 / -
6,5	19	VL-21065	143,86 / -
10	31	VL-21100	178,91 / -
15	42,5	VL-21150	227,21 / -
20	57,5	VL-21200	292,44 / -
P1		VL-21001	142,39 / -



GN 1/1 530 x 325 mm

h cm	cap l	Nr kat.	PLN/EUR
2	2,5	VL-11020	43,88 / -
4	5	VL-11040	51,83 / -
6,5	9	VL-11065	57,87 / -
10	14	VL-11100	78,78 / -
15	21	VL-11150	119,42 / -
20	28	VL-11200	138,86 / -
P1		VL-11001	56,99 / -
P2		—	—
P3		VL-11001S	147,69 / -
P4		—	—



GN 2/3 325 x 354 mm

h cm	cap l	Nr kat.	PLN/EUR
2	1,5	VL-23020	33,28 / -
4	3	VL-23040	40,79 / -
6,5	5,5	VL-23065	49,18 / -
10	9	VL-23100	67,74 / -
15	13	VL-23150	102,49 / -
20	18	—	—
P1		VL-23001	42,70 / -
P2		—	—
P3		VL-23001S	130,46 / -



GN 1/2 265 x 325 mm

h cm	cap l	Nr kat.	PLN/EUR
2	1,2	VL-12020	23,27 / -
4	2	VL-12040	30,19 / -
6,5	4	VL-12065	38,57 / -
10	6,5	VL-12100	50,36 / -
15	9,5	VL-12150	75,24 / -
20	12,5	VL-12200	90,41 / -
P1		VL-12001	30,48 / -
P2		—	—
P3		VL-12001S	108,38 / -
P4		—	—





GN 1/3 175 x 325 mm

h cm	cap l	Nr kat.	PLN/EUR
2	0,7	VL-13020	20,76/-
4	1,5	VL-13040	26,21/-
6,5	2,5	VL-13065	27,54/-
10	4	VL-13100	39,17/-
15	5,7	VL-13150	60,81/-
20	7,8	VL-13200	69,21/-
P1		VL-13001	20,32/-
P2		—	—
P3		VL-13001S	85,26/-



GN 2/4 530 x 162 mm

h cm	cap l	Nr kat.	PLN/EUR
10	5,8	VL-24100	63,02/-
15	8,6	VL-24150	101,46/-
P1		VL-24001	34,90/-



GN 1/4 162 x 265 mm

h cm	cap l	Nr kat.	PLN/EUR
4	1	—	—
6,5	1,8	VL-14065	25,33/-
10	2,8	VL-14100	36,08/-
15	4	VL-14150	54,04/-
20	5,5	VL-14200	60,67/-
P1		VL-14001	18,55/-
P2		—	—
P3		VL-14001SIL	72,59/-



GN 1/6 162 x 176 mm

h cm	cap l	Nr kat.	PLN/EUR
6,5	1	VL-16065	20,03/-
10	1,6	VL-16100	27,83/-
15	2,4	VL-16150	38,58/-
20	3,4	VL-16200	53,60/-
P1		VL-16001	13,25/-
P2		—	—
P3		VL-16001S	51,39/-



GN 1/9 108 x 176 mm

h cm	cap l	Nr kat.	PLN/EUR
6,5	0,6	VL-19065	16,20/-
10	0,8	VL-19100	25,03/-
15	1,4	VL-19150	32,84/-
P1		VL-19001	10,31/-

POJEMNIKI GN PRIX – PERFOROWANE | PERFORATED PRIX GN CONTAINERS



GN 1/1 530 x 325 mm

h cm	cap l	Nr kat.	PLN/EUR
4	5	VL-11040P	63,91/-
6,5	9	VL-11065P	69,94/-
10	14	VL-11100P	90,85/-
15	21	VL-11150P	131,79/-
20	28	VL-11200P	151,08/-



GN 2/3 325 x 354 mm

h cm	cap l	Nr kat.	PLN/EUR
6,5	5,5	VL-23065P	56,40/-
10	9	VL-23100P	74,80/-



GN 1/2 265 x 325 mm

h cm	cap l	Nr kat.	PLN/EUR
6,5	4	VL-12065P	41,38/-
10	6,5	VL-12100P	57,57/-



Zobacz wózki do tac GN na str. 194

See GN trolleys on page 194



POJEMNIKI GN Z PORCELANY | PORCELAIN GN CONTAINERS

Verlo



biały połysk / white gloss



GN 1/1 530 x 325 mm

biały połysk | white

h cm	cap l	Nr kat.	op.	PLN/EUR
2,2	2,5	V-BUGN-11022-2	2	306,35/-
6,5	9	V-BUGN-11065-1	1	306,35/-



GN 2/3 325 x 354 mm

biały połysk | white gloss

h cm	cap l	Nr kat.	op.	PLN/EUR
2,2	1,5	V-BUGN-23022-3	3	162,47/-
6,5	5,5	V-BUGN-23065-1	1	162,47/-



GN 1/2 265 x 325 mm

biały połysk | white gloss

h cm	cap l	Nr kat.	op.	PLN/EUR
2,2	1,2	V-BUGN-12022-3	3	161,34/-
6,5	4	V-BUGN-12065-2	2	161,34/-



GN 1/3 175 x 325 mm

biały połysk | white gloss

h cm	cap l	Nr kat.	op.	PLN/EUR
2,2	0,7	V-BUGN-13022-6	6	116,21/-
6,5	2,5	V-BUGN-13065-3	3	116,21/-



GN 2/4 530 x 162 mm

biały połysk | white gloss

h cm	cap l	Nr kat.	op.	PLN/EUR
2,2	1,2	V-BUGN-24022-4	4	138,68/-
6,5	4	V-BUGN-24065-2	2	184,66/-



biały mat / matte white



szary mat / matte grey



czarny mat / matte black



GN 1/1 530 x 325 mm

biały mat | matte white

h cm	cap l	Nr kat.	op.	PLN/EUR
2,2	2,5	—	—	—
6,5	9	R-NFBU-11065WH-1	1	447,62/-

szary mat | matte grey

h cm	cap l	Nr kat.	op.	PLN/EUR
2,2	2,5	R-NFBU-11022GY-2	2	447,62/-
6,5	9	—	—	—

czarny mat | matte black

h cm	cap l	Nr kat.	op.	PLN/EUR
2,2	2,5	R-NFBU-11022BK-2	2	447,62/-
6,5	9	R-NFBU-11065BK-1	1	447,62/-



GN 1/2 265 x 325 mm

biały mat | matte white

h cm	cap l	Nr kat.	op.	PLN/EUR
2,2	1,2	—	—	—
6,5	4	R-NFBU-12065WH-2	2	235,72/-

szary mat | matte grey

h cm	cap l	Nr kat.	op.	PLN/EUR
2,2	1,2	R-NFBU-12022GY-3	3	235,72/-
6,5	4	R-NFBU-12065GY-2	2	235,72/-

czarny mat | matte black

h cm	cap l	Nr kat.	op.	PLN/EUR
2,2	1,2	R-NFBU-12022BK-3	3	235,72/-
6,5	4	R-NFBU-12065BK-2	2	235,72/-





Pojemnik GN 1/1 emaliowany
Enamelled GN container

Nr kat.	l cm	h cm	w cm	cap l	PLN	EUR
M3-11020	53	2	32,5	2,5	98,80	-
M3-11040	53	4	32,5	5	106,60	-
M3-11065	53	6,5	32,5	9	114,30	-



Blacha GN 1/1; Al, non-stick
Sheet GN 1/1; Al, non-stick

Nr kat.	l cm	h cm	w cm	thk mm	PLN	EUR
D-8161-53	53	1	32,5	2	123,46	-



Taca do gotowania jaj GN 1/1; 18/10
Boiled eggs frame GN 1/1 18/10

Nr kat.	l cm	h cm	w cm	PLN	EUR
T-7038	47	3	28,5	296,88	-

Otwory o śr. 35 mm • Na 38 jaj
Holes ø 35 mm • Holds 38 eggs



Blacha GN do jaj sadzonych z powłoką non-stick
Fried eggs pan GN; non-stick

Nr kat.	l cm	h cm	w cm	PLN	EUR
T-MR11007	47	3	28,5	439,19	-

8 miejsc wypiekowych
8 baking pockets



Ruszt GN; 18/10
Grate GN; 18/10

Nr kat.	l cm	w cm	PLN	EUR	
T-R23001	GN 2/3	35,4	32,5	66,03	-
T-R11001	GN 1/1	53	32,5	65,55	-
T-R21001	GN 2/1	65	53	130,70	-

Grubość drutów: 3 mm, rama 6 mm
Thickness of the wire: 3 mm, frame 6 mm



Listwa wspornikowa; 18/10
Support bar; 18/10

Nr kat.	l cm	PLN	EUR
T-2903-53	53	22,23	-
T-2904-32	32,5	13,71	-



POJEMNIKI GN Z MELAMINY | MELAMINE GN CONTAINERS

Verlo



GN 1/1 530 x 325 mm



h cm	cap l		Nr kat.	op.	PLN/EUR
2	1,3	○	V-11020M	12	86,70 / -
2	1,3	●	N V-11020M-BK	12	84,79 / -
6,5	7,1		V-11065M	6	173,25 / -



GN 1/2 265 x 325 mm



h cm	cap l		Nr kat.	op.	PLN/EUR
2	0,8	○	V-12020M	24	45,15 / -
2	0,8	●	N V-12020M-BK	24	44,18 / -
6,5	3,4		V-12065M	12	90,00 / -
10	5,5		V-12100M	12	110,25 / -



GN 1/3 175 x 325 mm



h cm	cap l		Nr kat.	op.	PLN/EUR
2	0,4		V-13020M	24	42,60 / -
6,5	2		V-13065M	12	65,85 / -
10	3,15		V-13100M	12	89,25 / -



GN 1/6 176 x 162 mm



h cm	cap l		Nr kat.	op.	PLN/EUR
6,5	1		V-16065M	24	51,30 / -
10	1,6		V-16100M	12	62,85 / -

AKCESORIA | ACCESSORIES

Pokrywa GN 1/1; PC
Cover GN 1/1; PC

Nr kat.	l cm	h cm	w cm	PLN	EUR
V-61100-L	53	10	33	151,35	-

Pokrywa GN 1/2; PC
Cover GN 1/2; PC

Nr kat.	l cm	h cm	w cm	PLN	EUR
V-61200-L	32,5	10	27	81,75	-

Pokrywa roll top; PC
Cover roll top GN 1/1; PC

Nr kat.	l cm	h cm	w cm	PLN	EUR
V-61199	32,5	17	53	145,35	-



- Do przechowywania, transportu i wydawania posiłków
- Szybka lokalizacja zawartości bez otwierania pojemnika
- Łatwa kontrola świeżości przechowywanej żywności
- Łatwe w utrzymaniu czystości, higieniczne
- Pojemniki PC można używać w kuchence mikrofalowej
- Możliwość zamontowania kolorowych klipsów na pokrywie
- For storing, transporting and serving meals
- Contents easy to recognise without opening the container
- Convenient control of the freshness of stored food
- Easy to clean, hygienic
- PC containers are safe to use with microwave ovens
- Coloured lid clips are optional



GN 1/1 530 x 325 mm

poliwęglan | polycarbonate
|temp. -40°C – 99°C|

poliwęglan | polycarbonate
|temp. -40°C – 99°C|

polipropylen | polypropylene
|temp. -40°C – 80°C|

h cm	cap l	Nr kat.	PLN / EUR	Nr kat.	PLN / EUR	Nr kat.	PLN / EUR
6,5	9	CM-12CW135	44,18/-	CM-12CW110	44,18/-	CM-12PP190	26,86/-
10	14	CM-14CW135	55,96/-	CM-14CW110	55,96/-	CM-14PP190	33,13/-
15	21	CM-16CW135	68,69/-	CM-16CW110	68,69/-	CM-16PP190	42,43/-
20	28	CM-18CW135	87,88/-	—	—	CM-18PP190	55,18/-
P1		CM-10CWC135	38,00/-	—	—	—	—
P5		CM-10PPCWSC190	27,55/-	—	—	CM-10PPCWSC190	27,55/-
P6		CM-10CWD135	46,55/-	—	—	—	—



GN 1/2 265 x 325 mm

h cm	cap l	Nr kat.	PLN / EUR	Nr kat.	PLN / EUR	Nr kat.	PLN / EUR
6,5	4	CM-22CW135	24,80/-	CM-22CW110	24,80/-	CM-22PP190	15,99/-
10	6,5	CM-24CW135	31,73/-	CM-24CW110	31,73/-	CM-24PP190	20,06/-
15	9,5	CM-26CW135	40,76/-	CM-26CW110	40,76/-	CM-26PP190	25,50/-
20	12,5	CM-28CW135	49,21/-	—	—	CM-28PP190	31,25/-
P1		CM-20CWC135	18,34/-	—	—	—	—
P5		CM-20PPCWSC190	15,15/-	—	—	CM-20PPCWSC190	15,15/-
P6		CM-20CWD135	13,68/-	—	—	—	—



GN 1/3 175 x 325 mm

h cm	cap l	Nr kat.	PLN / EUR	Nr kat.	PLN / EUR	Nr kat.	PLN / EUR
6,5	2,5	CM-32CW135	19,10/-	CM-32CW110	19,10/-	CM-32PP190	12,33/-
10	4	CM-34CW135	24,70/-	CM-34CW110	24,70/-	CM-34PP190	14,35/-
15	5,7	CM-36CW135	30,78/-	CM-36CW110	30,78/-	CM-36PP190	19,65/-
20	7,8	CM-38CW135	38,57/-	—	—	CM-38PP190	23,72/-
P1		CM-30CWC135	12,92/-	—	—	—	—
P5		CM-30PPCWSC190	11,08/-	—	—	CM-30PPCWSC190	11,08/-
P6		—	—	—	—	—	—



GN 1/4 162 x 265 mm

h cm	cap l	Nr kat.	PLN / EUR	Nr kat.	PLN / EUR	Nr kat.	PLN / EUR
6,5	1,8	CM-42CW135	16,17/-	CM-42CW110	16,17/-	CM-42PP190	11,29/-
10	2,8	CM-44CW135	18,53/-	CM-44CW110	18,53/-	CM-44PP190	11,95/-
15	4	CM-46CW135	25,56/-	CM-46CW110	25,56/-	CM-46PP190	15,78/-
P1		CM-40CWC135	9,94/-	—	—	—	—
P5		CM-40PPCWSC190	8,42/-	—	—	CM-40PPCWSC190	8,42/-
P6		—	—	—	—	—	—





GN 1/6 162 x 176 mm

h cm	cap l	transparentne <i>transparent</i>		czarne <i>black</i>		polipropylen <i>polypropylene</i>	
		Nr kat.	PLN/EUR	Nr kat.	PLN/EUR	Nr kat.	PLN/EUR
6,5	1	CM-62CW135	11,31/-	CM-62CW110	11,31/-	CM-62PP190	7,42/-
10	1,6	CM-64CW135	13,68/-	CM-64CW110	13,68/-	CM-64PP190	8,57/-
15	2,4	CM-66CW135	17,43/-	CM-66CW110	17,43/-	CM-66PP190	11,18/-
P1		CM-60CWC135	6,56/-	—	—	—	—
P5		CM-60PPCWSC190	5,38/-	—	—	CM-60PPCWSC190	5,38/-
P6		—	—	—	—	—	—



GN 1/9 108 x 176 mm

h cm	cap l	transparentne <i>transparent</i>		czarne <i>black</i>		polipropylen <i>polypropylene</i>	
		Nr kat.	PLN/EUR	Nr kat.	PLN/EUR	Nr kat.	PLN/EUR
6,5	0,6	CM-92CW135	9,79/-	—	—	CM-92PP190	8,65/-
10	0,8	CM-94CW135	10,45/-	—	—	CM-94PP190	9,72/-
P1		CM-90CWC135	6,33/-	—	—	—	—
P5		CM-90PPCWSC190	4,78/-	—	—	CM-90PPCWSC190	4,78/-

Pojemnik magazynowy; PC
Storage container; PC

Nr kat.	l cm	h cm	w cm	cap l	PLN	EUR
CM-2SFSCW	18,5	10	18,5	1,9	27,08	-
CM-4SFSCW	18,5	18,7	18,5	3,8	41,33	-
CM-6SFSCW	21,5	18,5	21,5	5,7	59,42	-
CM-8SFSCW	21,5	23	21,5	7,6	70,68	-
CM-12SFSCW *	25,6	21	31	11,4	86,93	-
CM-18SFSCW *	25,6	32	31	17,2	135,95	-
CM-22SFSCW *	25,6	40	31	20,8	162,45	-

* - z uchwytem

* - with handle

Pokrywa do pojemnika; PP
Lid for container; PP

Nr kat.		PLN	EUR
CM-SFC12SCPP	do pojemników 11,4 l, 17,2 l, 20,8 l	31,04	-
CM-SFC2SCPP	do pojemników 1,9 l, 3,8 l	17,14	-
CM-SFC6SCPP	do pojemników 5,7 l, 7,6 l	21,11	-



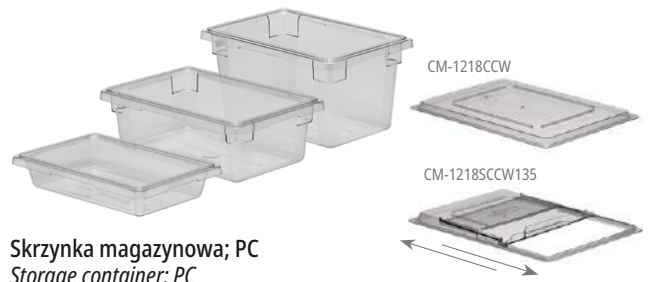

Skrzynka magazynowa; PC
Storage container; PC

Nr kat.	l cm	h cm	w cm	cap l	PLN	EUR
CM-12183CW	46	9	30,5	6,6	114,29	-
CM-12186CW	46	15	30,5	11,5	144,97	-
CM-12189CW	46	23	30,5	18	195,61	-
CM-1218CCW	<i>pokrywa standardowa</i> 45,7		30,5		70,97	-
CM-1218SCCW135	<i>pokrywa rozsuwana</i> 45,7		30,5		150,96	-

Pojemności od 6,6 l do 83,3 l • Wykonane z trwałego poliwęglanu • Przezroczyste, co umożliwia łatwą identyfikację zawartości • Specjalnie zaprojektowane pokrywy pozwalają utrzymać odpowiednią wilgotność przechowywanych produktów • Do magazynów, chłodni i transportu

Capacity from 6.6 liters to 83.3 liters • Made of durable polycarbonate • Transparent, which allows easy identification of content • Specially designed covers allow to maintain the appropriate humidity of stored products • For warehouses, cold storage and transport



Skrzynka magazynowa; PC
Storage container; PC

Nr kat.	l cm	h cm	w cm	cap l	PLN	EUR
CM-18263CW	66	9	46	18,9	209,19	-
CM-18266CW	66	15	46	33,1	271,13	-
CM-18269CW	66	23	46	49,2	356,16	-
CM-182615CW	66	38	46	83,3	511,77	-
CM-1826CCW	<i>pokrywa standardowa</i> 66		45,7		142,31	-
CM-1826SCCW	<i>pokrywa rozsuwana</i> 66		45,7		254,70	-

Pojemności od 6,6 l do 83,3 l • Wykonane z trwałego poliwęglanu • Przezroczyste, co umożliwia łatwą identyfikację zawartości • Specjalnie zaprojektowane pokrywy pozwalają utrzymać odpowiednią wilgotność przechowywanych produktów • Do magazynów, chłodni i transportu

Capacity from 6.6 liters to 83.3 liters • Made of durable polycarbonate • Transparent, which allows easy identification of content • Specially designed covers allow to maintain the appropriate humidity of stored products • For warehouses, cold storage and transport



Wózek na produkty sypkie z pokrywą; PP

Nr kat.	l cm	h cm	w cm	cap l	PLN	EUR
CM-IBS27	75	71	42	102	1 833,12	-

Nie absorbuje zapachu żywności • Przezroczysta pokrywa umożliwia szybką identyfikację zawartości • Wymiary przystosowane do wsuwania pod standardowy stół roboczy • Bardzo stabilne szerokie kółka z litej gumy • W komplecie z pokrywą

Does not absorb odour of ingredients • Comfortable clear sliding lid reduces handling and allows for quick content identification • Designed to fit under standard work tables • Casters feature wide wheels for excellent stability • Including lid



T-8023



T-9012

Pojemnik na jajka; PP
Eggs box; PP

Nr kat.	l cm	h cm	w cm	PLN	EUR
T-8023	<i>pojemnik</i> 28	20	31	174,80	-
T-9012	<i>tacka na jajka</i>			12,59	-

W komplecie z 8 tackami • 1 tacka / 30 jajek

Including 8 egg trays • 1 tray / 30 eggs





Misa z wygiętym rantem; 18/10
Rolled edge bowl; 18/10

Nr kat.	Ø cm	h cm	cap l	PLN	EUR
T-2360-12	12	7	0,6	15,11	-
T-2360-16	16	8	1	19,74	-
T-2360-20	20	9	2	24,18	-
T-2360-24	24	10	3,1	29,76	-
T-2360-30	30	12,5	5	48,17	-
T-2360-36	36	13,5	8,2	56,93	-



Misa z wygiętym rantem; 18/10
Rolled edge bowl; 18/10

Nr kat.	Ø cm	h cm	cap l	PLN	EUR
T-2380-40	40	12	7	62,00	-
T-2380-50	50	13,5	14	86,82	-
T-2380-55	55	14	19	102,88	-
T-2380-60	60	16	28	140,54	-
T-2380-70	70	19	43	212,67	-
T-2380-80	80	20	62	302,95	-



Misa z miarką; 18/10
Bowl with measure; 18/10

Nr kat.	Ø cm	h cm	cap l	PLN	EUR
T-513-08	21,5	9	1,5	65,74	-
T-513-11	26,5	11	3	82,75	-
T-513-15	31,5	13	5	109,06	-

Zaokrąglony rant zapewnia komfort pracy • Płaskie dno
Open rolled rim for comfortable work • Flat bottom



Misa z wygiętym rantem; 18/10
Rolled edge bowl; 18/10

Nr kat.	Ø cm	h cm	cap l	PLN	EUR
D-3250-40	40	17,5	16	209,30	-



Misa do miksowania; 18/10, silikon
Mixing bowl; 18/10, silicone

Nr kat.	Ø cm	h cm	cap l	PLN	EUR
D-3373-16	16	8,1	1	109,10	-
D-3373-20	20	10,2	2,1	145,35	-
D-3373-24	24	12,1	3,6	181,94	-
D-3373-30	30	14,8	7	224,35	-

Antypoślizgowa silikonowa podstawa • Podziałka wewnątrz
Anti-slip silicone base • Interior graduations



Misa cukiernicza; PP
Pastry bowl; PP

Nr kat.	Ø cm	h cm	cap l	PLN	EUR
D-4530-17	17	8	1	17,78	-
D-4530-23	23	10,5	2,5	23,26	-
D-4530-27	27	12	4,5	25,99	-
D-4530-32	32	15	6	37,62	-
D-4530-36	36	16	9	41,72	-
D-4530-40	40	18,5	13	60,88	-

Otwarty rant
Open rim



Misa sztaplowalna; szkło
Stackable bowl; glass

Nr kat.	Ø cm	cap l	op.	PLN	EUR
DX-511710-4	7,5	0,07	4	3,14	-
DX-511670-4	9	0,125	4	3,23	-
DX-511680-6	10,5	0,2	6	3,52	-
DX-511690-6	12	0,31	6	4,09	-
DX-511730-6	14	0,5	6	5,99	-
DX-512290-6	17	0,97	6	7,89	-
DX-511740-6	20	1,59	6	10,17	-
DX-511750-6	23	2,4	6	14,63	-
DX-511760-6	26	3,45	6	23,47	-
DX-511770-3	31	5,8	3	34,58	-

Hartowane szkło • zakres temperatur: -20°C—130°C
Tempered glass • temp. range: -20°C—130°C



Wanna okrągła; 18/10
Basin; 18/10

Nr kat.	Ø cm	h cm	cap l	thk mm	PLN	EUR
T-50840	40	19	15	7	245,48	-
T-50845	45	21	22	7	293,17	-
T-50850	50	23	30	7	351,69	-

Grubość ścianki 0,7 mm • Maksymalne obciążenie do 50 kg
Steel thickness 0,7 mm • Max. load 50 kg



Wanna z pierścieniem; 18/10
Basin with foot; 18/10

Nr kat.	Ø cm	h cm	cap l	PLN	EUR
T-3001-600	60	28	56	1 903,00	-

Ruchome uchwyty
Movable handles





Misa do miksowania; 18/10
Mixing bowl; 18/10

Nr kat.	Ø cm	h cm	cap l	PLN	EUR
T-50327	26	14	4	220,88	-
T-50333	32	18	9,5	283,86	-
T-50337	36	17,5	12	305,24	-



Misa do miksowania; 18/10
Mixing bowl; 18/10

Nr kat.	Ø cm	h cm	cap l	PLN	EUR
T-1954-36	36	29	25	801,36	-
T-1954-40	40	35,5	40	994,19	-



Podstawa pod misę do miksowania; 18/10
Mixing bowl support; 18/10

Nr kat.	Ø cm	PLN	EUR
D-3379-00	10,8	60,53	-

D-3379-00 pasuje do mis o śr.: 20-24 cm • D-3379-01 pasuje do mis o śr.: 30-45 cm

D-3379-00 fits the following mixing bowl diameters: 20-24 cm
• D-3379-01 fits the following mixing bowl diameters: 30-45 cm



Misa do przetworów; miedź
Jam bowl; copper

Nr kat.	Ø cm	h cm	cap l	PLN	EUR
D-6200-38N	38	15	9	531,81	-

Żeliwne uchwyty • NIE wolno zapiekać w piekarniku
Cast iron handles • CAN'T be used in the oven



Wiadro; 18/10
Bucket; 18/10

Nr kat.	h cm	cap l	PLN	EUR
T-415-007	27	7	202,92	-
T-415-010	27	10	241,97	-
T-415-012	30	12	274,17	-
T-415-015	34	15	295,93	-

Podziałka litrów wewnątrz
Interior liter graduations



Wiadro z pierścieniem; 18/10
Bucket with foot; 18/10

Nr kat.	h cm	cap l	PLN	EUR
T-416-010	25,5	10	338,77	-
T-416-012	29	12	368,60	-
T-416-015	33	15	388,93	-

Podziałka litrów wewnątrz
Interior liter graduations



Pokrywa do wiadra; 18/10
Lid for bucket; 18/10

Nr kat.	→ □	PLN	EUR
T-418-007	wiadro 7 l	79,42	-
T-418-010	wiadro 10 l	93,39	-
T-418-012	wiadro 12 l	101,75	-
T-418-015	wiadro 15 l	109,35	-



Wanna przecedzakowa z pierścieniem; 18/10
Colander with foot; 18/10

Nr kat.	Ø cm	h cm	cap l	PLN	EUR
D-3930-32	32	20	14,5	278,87	-
D-3930-40	40	26	18	355,51	-
D-3930-48	50	33	22	525,41	-

Grubość ścianki 0,7 mm • Maksymalne obciążenie do 50 kg • Otwory 4 mm na ściankach i dnie

Steel thickness 0,7 mm • Max load 50 kg • Holes ø 4 mm on walls and bottom



Cedzak; 18/10
Colander; 18/10

Nr kat.	Ø cm	l cm	PLN	EUR
T-1926-22	22	51	278,10	-
T-1926-26	26	55	319,77	-

Otwory śr. 4 mm
Holes dia 4 mm



Cedzak z uchwytemi; 18/10
Colander with handles; 18/10

Nr kat.	Ø cm	l cm	h cm	PLN	EUR
T-81082	26	33,5	16,2	72,12	-

Otwory śr. 4 mm
Holes dia 4 mm





Dynamik

de Buyer

Wirówka do sałaty; PP Salad spinner; PP

Nr kat.	Ø cm	h cm	cap l	PLN	EUR
DY-E007	27	34	5	541,33	-
DY-E001	33	42	10	615,51	-

Nr kat.	Ø cm	h cm	cap l	PLN	EUR
DY-E002	43	50	20	704,85	-
DY-AC019 podstawa	36	17		308,66	-

Nie zawiera podstawy w zestawie • E001 - do 4 główek, waga 2,4 kg, E002 - do 8 główek waga 3,6 kg, E007 - waga 1,6 kg

Base sold separately

Sito; 18/10 Sieve; 18/10

Nr kat.	Ø cm	h cm	PLN	EUR
T-1080-200	20	6,2	57,67	-
T-1080-250	25	6,3	68,05	-
T-1080-300	30	7	87,19	-
T-1080-350	35	7,5	101,52	-

Drobna siatka (8 otworów/cm²)

Fine filtration mesh (8 holes/cm²)

Sito z wymiennymi siatkami; 18/10 Sieve with spare nets; 18/10

Nr kat.	Ø cm	h cm	PLN	EUR
D-4605-21	20	6	143,64	-

W zestawie 4 sita: 3 mm, 2 mm, 1mm, 0,5 mm.

4 sieves included: 3 mm, 2 mm, 1mm, 0,5 mm.

BarEq



Sito z siatką; stal cynowana, drewno Soup strainer; tin, wood

Nr kat.	Ø cm	l cm	PLN	EUR
T-2635-30	30	78	114,24	-
T-2635-35	35	84	149,31	-

Podwójna siatka: zewnętrzna mocna i gęsta, wewnętrzna 6,5 otworów/cm² • Stalowy łuk chroniący

Double mesh: external thick and dense, internal 6,5 holes/cm² • Thick steel wire to protect the mesh



Sitko - bardzo gęste; 18/10 Fine strainer; 18/10

Nr kat.	Ø cm	l cm	PLN	EUR
T-1210	7	21	20,10	-



Pałka do przecierania; buk Pusher for conical strainer; beechwood

Nr kat.	Ø cm	l cm	PLN	EUR
T-8260	4	29	17,81	-



Sito; 18/10 Sieve; 18/10

Nr kat.	Ø cm	l cm	PLN	EUR
T-3190-12	12	28,5	25,07	-
T-3190-16	16	33,5	27,17	-
T-3190-20	20	39,5	40,51	-
T-3190-22	22	43,5	50,26	-

Drobna siatka (6,5 otworów/cm²)

Fine filtration mesh (6,5 holes/cm²)



Sito stożkowe; 18/10 Conical strainer; 18/10

Nr kat.	Ø cm	l cm	h cm	PLN	EUR
T-1153-16	16	37	16	77,52	-
T-1153-20	20	40	20	88,35	-
T-1153-23	23	42,5	23	104,12	-
T-1153-27	27	46	27	137,37	-

Otwory 1,5 mm, na końcówce 2,0 mm

Holes dia 1,5 mm, 2,0 mm on the tip



Sito stożkowe siatkowe - Fine Strainer; 18/10 Conical fine strainer; 18/10

Nr kat.	Ø cm	l cm	h cm	PLN	EUR
T-520-20	20	37	18	245,48	-
T-520-24	24	47	21	315,78	-

Stalowy łuk chroniący sito przed uszkodzeniem

Thick steel wire to protect the mesh



Sito chińskie; 18/10
Chinese strainer; 18/10

Nr kat.	Ø cm	l cm	h cm	PLN	EUR
T-60321	20	40	12,5	139,37	-



Stojak do sita stożkowego; 18/10
Conical strainer support; 18/10

Nr kat.	Ø cm	h cm	PLN	EUR
T-3318	18	28	85,68	-

Pasuje do wszystkich rozmiarów sit stożkowych

Fits all sizes conical sieves

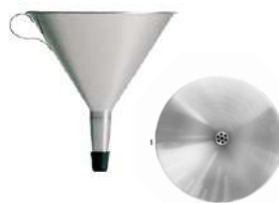

Lejek z sitkiem; 18/10
Funnel with strainer; 18/10

Nr kat.	Ø cm	h cm	PLN	EUR
T-588-03	20	23	147,63	-

Średnica dolna: 1,8 cm; średnica oczek sitka: 4 mm
Bottom diameter: 1.8 cm; strainer's mesh diameter: 4 mm



Lejek z sitkiem; 18/10
Funnel with strainer; 18/10

Nr kat.	Ø cm	h cm	PLN	EUR
T-62513	12	11,5	60,61	-
T-62515	14	12	69,45	-
T-62531	10	11	51,68	-



Lejek ze stoperem; polipropylen
Funnel with stop; polypropylene

Nr kat.	Ø cm	h cm	w cm	PLN	EUR
BP-IM3-010	14,5	15,5	22,5	56,10	-

Funkcja antydrop • spust umożliwiający zatrzymanie przelewającego płynu

Anti-drop function • Trigger to stop overflowing liquid

Blim



Lejek do słoików i napełniania ringów cukierniczych; 18/10
Funnel for jam and to pour preparations in ring; 18/10

Nr kat.	Ø cm	PLN	EUR
D-3356-00	15	136,46	-

Produkt dwuelementowy • Średnice dolne: 3,3 cm oraz 5,6 cm • Również do dekorowania talerzy

Product consists of 2 elements • Bottom diameters: 3.3 cm and 5.6 cm • For plate decorations also

de Buyer



Pistolet do sosów i kremów; 18/10
Automatic dispenser; 18/10

Nr kat.	cap l	PLN	EUR
T-1033-05	1,5	174,88	-

w zestawie dwie końcówki i stojak
included two nozzles and stand

de Buyer



Pistolet do sosów i kremów; 18/10
Automatic dispenser; 18/10

Nr kat.	Ø cm	h cm	cap l	PLN	EUR
D-3353-00	15	15,5	0,8	204,86	-

Idealny do dekorowania sosami, napełniania form itp.
Perfect for decorating sauces, filling molds, etc.

de Buyer



Pistolet do sosów i kremów; 18/10
Automatic dispenser; 18/10

Nr kat.	Ø cm	h cm	cap l	PLN	EUR
D-3354-12	17,5	16,5	1,5	591,32	-
D-3354-52	20	38	3,3	680,58	-

Idealny do dekorowania sosami, napełniania form itp.
Perfect for decorating sauces, filling molds, etc.

de Buyer



Mikser z przystawką blendującą 160
Mixer with blender attachment 160

Nr kat.	Ø cm	W	obr./m	kg	PLN	EUR
DY-MX100	7	220	0 - 13.000	1	1 472,46	-

Regulowana ilość obrotów • Demontowalna część robocza • Element rozdrabniający stal 18/10 wzmocniony powłoką tytanową • Działa na zasadzie miążdżenia • Może pełnić funkcję przecieraka

Variable speed easily switchable • Detachable foot • Titanium coated 18/10 steel bell • Operates by crushing • Can also be used as a food mill

Dynamik

KUP ON-LINE



PRZECIERAK ELEKTRYCZNY? Więcej informacji na str. 132–143
ELECTRICAL FOOD MILL? See pages 132–143 for more information



N

Przecierak do warzyw; 18/10
Food mill; 18/10

Nr kat.	Ø cm	l cm	h cm	PLN	EUR
EB-52232	32	41,5	13	499,00	-

3 różne dyski do przecierania • Zdejmowane ostrze
3 models of sieve discs • Removable blade



N

Przecierak do warzyw; 18/10
Food mill; 18/10

Nr kat.	Ø cm	l cm	h cm	PLN	EUR
EB-52242	24	40	12	199,00	-



Wyciskacz do puree; 18/10
Puree pusher; 18/10

Nr kat.	Ø cm	l cm	cap l	PLN	EUR
T-1336-360	8	36	0,4	235,13	-



Przecierak do warzyw; 18/10
Food mill; 18/10

Nr kat.	Ø cm	h cm	PLN	EUR
D-2004-00	37	40	1 846,80	-

Sito; 18/10
Sieve; 18/10

Nr kat.	Ø o mm	PLN	EUR
D-2004-10N	1	731,88	-
D-2004-15N	1,5	571,14	-
D-2004-20N	2	571,14	-
D-2004-30N	3	571,14	-
D-2004-40N	4	731,88	-

Sita do kupienia osobno • Łatwy montaż i demontaż
Sieves sold separately • Easily disassembled



Prasa do puree; 18/10
Puree press; 18/10

Nr kat.	Ø cm	l cm	h cm	PLN	EUR
T-62902	8	28	11	140,98	-



Dzbanek miarka; 18/10
Measuring jug; 18/10

Nr kat.	Ø cm	h cm	cap l	PLN	EUR
T-551-05	10	11	0,5	40,85	-
T-551-1	14	14	1	57,19	-
T-551-2	16	19	2	112,10	-

Podziałka wewnętrzna
Interior graduations



Dzbanek miarka sztaplowalna; 18/10
Stackable measuring jug; 18/10

Nr kat.	Ø cm	h cm	cap l	PLN	EUR
T-512-03	11,5	11	0,5	37,62	-
T-512-04	15	13	1	51,30	-
T-512-05	15,5	15	1,5	87,31	-
T-512-06	17	19	2	100,61	-



Dzbanek miarka; 18/10
Measuring jug; 18/10

Nr kat.	Ø cm	h cm	cap l	PLN	EUR
T-1390-100	10,5	14	1	50,51	-

Podziałka zewnętrzna i wewnętrzna
Interior and outer graduations





Dzbanek miarka; PP
Measuring jug; PP

Nr kat.	cap l	PLN	EUR
T-126-010	0,25	12,58	-
T-126-011	0,5	13,15	-
T-126-012	1	18,43	-
T-126-013	2	31,26	-
T-126-014	3	40,99	-
T-126-015	5	50,98	-



Zestaw miarek; 18/0
Measuring cups; 18/0

Nr kat.	PLN	EUR
T-80037	33,10	-

60 ml, 80 ml, 125 ml, 250 ml

TOMGAST



Porcjoner; 18/10, tworzywo
Ice cream spoon; 18/10

Nr kat.	l cm	PLN	EUR
T-41475	26	27,45	-



Szufelka; 18/10
Scoop; 18/10

Nr kat.	Ø cm	l cm	cap l	PLN	EUR
T-1037-09	7	26	0,4	73,06	-
T-1037-100	10	33	1	86,36	-
T-1037-120	12	36	2	95,57	-
T-1037-155	15,5	40	3	142,41	-



Szufelka; 18/10
Scoop; 18/10

Nr kat.	l cm	cap l	PLN	EUR
T-315	19	0,06	30,63	-
T-316	21	0,1	36,19	-
T-316A	24	0,2	43,23	-
T-316B	28	0,35	55,45	-
T-316C	31	0,5	62,12	-



BAR
PROFESSIONAL

Szufelka perforowana; 18/10
Perforated scoop; 18/10

Nr kat.	Ø cm	l cm	PLN	EUR
BPR-1002	5,5	19	40,00	-
T-1038-2	4,5	19	68,59	-



Szufelka; PE
Scoop; PE

Nr kat.	l cm	w cm	cap l	PLN	EUR
T-127-023	18,5	6,5	0,125	7,87	-
T-127-024	25	9	0,25	10,76	-
T-127-025	31	11,7	0,5	13,30	-
T-127-026	35	15	0,85	19,86	-



Łopatka do lodu; PC
Ice scoop; PC

Nr kat.	l cm	PLN	EUR
T-TB014	26,5	22,26	-

BarEq



Szufelka do nakładania frytek; 18/10
Scoop for french fries; 18/10

Nr kat.	l cm	w cm	PLN	EUR
DH-1510-018	18,5	18	63,65	-

KUP ON-LINE





Porcjoner; 18/10
Ice cream spoon; 18/10

Nr kat.	Ø cm	l cm	cap l	PLN	EUR
T-60-040	4	21,45	0,025	52,36	-
T-60-030	4,5	22	0,033	52,36	-
T-60-024	4,6	22	0,041	53,48	-
T-60-012	6,5	23,5	0,083	55,58	-
T-60-008	6,8	24	0,125	57,43	-



Porcjoner; 18/10, tworzywo
Ice cream spoon; 18/10

Nr kat.	Ø cm	l cm	grm g	cap l	PLN	EUR
T-STK17	4,1	22	17	0,025	195,41	-
T-STK19	4,4	22	19	0,028	195,41	-
T-STK23	4,5	22,5	23	0,033	195,41	-



Porcjoner; 18/10
Ice cream spoon; 18/10

Nr kat.	Ø cm	l cm	grm g	cap l	PLN	EUR
T-STC17	4,1	22,5	17	0,025	193,22	-
T-STC19	4,4	23	19	0,028	193,22	-
T-STC23	4,5	23	23	0,033	193,22	-

Uchwyt powlekany mosiądzem i chromem
The handle coated with brass and chrom

de Buyer



Porcjoner; Al polerowane
Ice cream spoon; Al. polished

Nr kat.	l cm	cap l	PLN	EUR
D-4815-00N	18	0,033	51,30	-

Rękojeść eutektyczna - ciepło dłoni rozgrzewa krawędź łyżki
Thermoactive handle - when gripped the warmth spreads over the whole spoon



Porcjoner; Al polerowane
Ice cream spoon; Al. polished

Nr kat.	l cm	grm g	cap l	PLN	EUR
T-STA17	17	17	0,025	141,84	-
T-STA23	17,5	23	0,033	141,84	-

Rękojeść eutektyczna - ciepło dłoni rozgrzewa krawędź łyżki
Thermoactive handle - when gripped the warmth spreads over the whole spoon



Porcjoner do lodów; Al polerowane
Ice cream disher; Al. polished

Nr kat.	l cm	cap l	PLN	EUR
T-70-120	18	0,015	14,26	-

Rękojeść eutektyczna - ciepło dłoni rozgrzewa krawędź łyżki
Thermoactive handle - when gripped the warmth spreads over the whole spoon



Dyspenser do sosów z miarką; PE
Sauce dispenser; PE

Nr kat.	Ø cm	h cm	cap l	PLN	EUR
T-61912	4	10	0,125	6,08	-
T-61925	5	19	0,25	6,46	-
T-61940	5,5	21,5	0,4	7,14	-
T-61970	7	26	0,7	7,81	-



Dyspenser do sosów z miarką; PE
Sauce dispenser; PE

Nr kat.	Ø cm	h cm	cap l	PLN	EUR
T-61925R	5	19	0,25	6,46	-
T-61940R	5,5	21,5	0,4	6,94	-
T-61970R	7	26	0,7	8,08	-



Dyspenser do sosów z miarką; PE
Sauce dispenser; PE

Nr kat.	Ø cm	h cm	cap l	PLN	EUR
T-61925A	5	19	0,25	6,46	-
T-61940A	5,5	21,5	0,4	6,94	-
T-61970A	7	26	0,7	8,08	-



Dyspenser do dekoracji; PP
Decoration dispenser; PP

Nr kat.	Ø cm	h cm	cap l	PLN	EUR
T-61974	7	20	0,47	16,15	-
T-61977	7	26	0,7	17,39	-



Dyspenser do sosów z miarką, precyzyjny; PE
Sauce dispenser; PE

Nr kat.	Ø cm	h cm	cap l	PLN	EUR
T-195-194	5,1	7,9	0,05	26,78	-
T-195-195	6,1	13,4	0,25	32,64	-
T-195-196	7,8	16,2	0,5	40,13	-
T-195-197	9,7	22,3	1	54,34	-



Zestaw dyspenserów precyzyjnych; PE
Set of squeeze bottles; PE

Nr kat.	Ø cm	h cm	cap ml	PLN	EUR
TF-225	3	8,5	30	26,13	-

4 szt
4 pcs



T-61136

T-61134

Pojemnik na przyprawę; tworzywo
Spice dispenser; plastic

Nr kat.	l cm	h cm	w cm	cap ml	PLN	EUR
T-61136	50	9	16	450	111,91	-
T-61134	50	9	16	750	111,91	-



mesh

1,5 mm

2,5 mm

Dyspenser do przypraw; 18/10
Spice dispenser; 18/10

Nr kat.	Ø cm	Ø o mm	h cm	PLN	EUR
T-1030-0	7	siateczka	10	32,11	-
T-1030-015	7	1,5	10	29,64	-
T-1030-025	7	2,5	10	29,64	-



Solniczka Al
Salt shaker; AL.

Nr kat.	Ø cm	h cm	PLN	EUR
TF-779	8	17	48,42	-



Waga Scales

Nr kat.		l cm	w cm	kg	PLN	EUR
T-12-02	do 3 kg, dokładność 0,001 kg	26,3	28,7	1,5	948,00	-
T-12-10	do 15 kg, dokładność 0,005 kg	26,3	28,7	1,5	948,00	-
T-12-30	do 30 kg, dokładność 0,01 kg	26,3	28,7	1,5	948,00	-

Podłączenie sieciowe lub baterie R20 • Dwuzakresowa • Wielokrotne tarowanie. • Szalka - stal nierdzewna • Podświetlenie klawiatury i wyświetlacza • Wymiary szalki: 23 x 19 cm • Waga z legalizacją

Power connection or batteries • Dual range capacity adjustment • Multiple taring • Platform 18/10 steel • Backlit keyboard and screen • Platform size: 23 x 19 cm • With legalisation



Waga magazynowa Platform scales

Nr kat.		l cm	w cm	kg	PLN	EUR
T-13-050	do 60 kg, dokładność 0,02 kg	36	58	19,8	1 980,00	-
T-13-150	do 150 kg, dokładność 0,05 kg	49	698	12,3	1 980,00	-

Zasilanie sieciowe lub akumulatorowe (6V, 3,6Ah) • Czas pracy na akumulatorze - ok. 100 godzin • Ruchomy wyświetlacz • Wodoodporna klawiatura • Mocna, odporna konstrukcja • Waga z legalizacją

Power connection or batteries (6V, 3,6Ah) • Battery operating time - aprox. 100 h • Adjustable display • Waterproof keyboard • Robust design • Waga z legalizacją



Waga precyzyjna; tworzywo, stal Precision scales; plastic, steel

Nr kat.	l cm	h cm	w cm	PLN	EUR
T-JF17	11	2	8	63,65	-

Niebieski wyświetlacz LCD • Funkcja tarowania • Baterie w zestawie • Zakres wagi: 0,1 - 500g

LCD screen • Functions: tare and auto-off • Supplied with batteries • Range of weight: 0,1 - 500g



Szpatuła z termometrem; silikon Spatula with thermometer; silicone

Nr kat.	l cm	PLN	EUR
T-14039	29	64,60	-

Zakres temp. od -50°C do +300°C
Temp. from -50°C to +300°C



Pirometr Pyrometer

Nr kat.	l cm	PLN	EUR
T-8700	13,1	307,96	-

Laserowy celownik • Zakres temperatur od -50°C do 330°C (dokładność pomiaru w zakresie 0°-330°C: +/-2°C) • Zasilanie baterią 9V • Wystarcza do 80 godzin pracy ciąglej

Laser type aimer • Temp. from -50°C to 330°C (measurement accuracy for 0°-330°C range is +/-2°C) • Batteries 9V • Battery operating time - aprox. 80 h



Termometr kuchenny Kitchen thermometer

Nr kat.	l cm	PLN	EUR
T-TER-3	15	9,91	-

Zakres temperatur od -25°C do 70°C
Temp. from -25°C to 70°C



Termometr piekarniczy; 18/10 Baking thermometer; 18/10

Nr kat.	PLN	EUR
T-TER-1	25,01	-

Zakres temperatur od 0°C do 300°C • Oprawa ze stali nierdzewnej 18/10
Temp. from 0°C to 300°C • Stainless steel 18/10



Termometr lodówkowy; 18/10 Fridge thermometer; 18/10

Nr kat.	PLN	EUR
T-TER-2	21,00	-

Zakres temperatur od -30°C do 30°C • Oprawa ze stali nierdzewnej 18/10
Temp. from -30°C to 30°C • Stainless steel 18/10



**Termometr elektroniczny z etui;
stal nierdzewna**
Electronic thermometer with a probe; SS

Nr kat.	l cm	PLN	EUR
T-1107	20,5	55,49	-

Zakres temperatur -50°C do +200°
Temp. from -50°C to +200°C



Termometr z sondą; stal nierdzewna
Thermometer with a probe; SS

Nr kat.	l cm	PLN	EUR
T-7840	14	19,48	-

Zakres temperatur od -10°C do 100°C
Temp. from -10°C to 100°C



Termometr do głębokiego tłuszczu; 18/10
Deep oil thermometer; 18/10

Nr kat.	l cm	PLN	EUR
T-7845	14	22,33	-

Zakres temperatur od 0°C do 250°C
Temp. from 0°C to 250°C



Ubijak do ziemniaków; 18/10
Potato masher; 18/10

Nr kat.	Ø cm	l cm	PLN	EUR
T-20-60	12,7	57,15	30,40	-



Ubijak do ziemniaków; 18/10
Potato masher; 18/10

Nr kat.	l cm	w cm	PLN	EUR
T-918-50	50	15,5	142,00	-
T-918-80	80	15,5	162,00	-

Grubość drutu ubijaka 6 mm
Wire thickness 6 mm



Ubijak do ziemniaków; 18/10
Potato masher; 18/10

Nr kat.	l cm	w cm	PLN	EUR
T-9825	29,5	10	36,10	-

Grubość drutu 4 mm
Wire thickness 4 mm



Wiosło; 18/10
Scull; 18/10

Nr kat.	dim cm	l cm	PLN	EUR
T-1740-137	11,5 x 17,5	137	110,29	-

Wymiary (dim cm) dotyczą końcówki.
Dimensions (dim cm) refer to the tip.



Wiosło; PE
Scull; PE

Nr kat.	dim cm	l cm	PLN	EUR
T-DP3050	10 x 14	150	243,73	-
T-DP3060	z perforacją	10 x 14	255,55	-

Wymiary (dim cm) dotyczą końcówki.
Dimensions (dim cm) refer to the tip.

KUP ON-LINE



Trzepaczka spiralna; 18/10
Spiral whisk; 18/10

Nr kat.	l cm	PLN	EUR
T-900-250	29	24,23	-



Różga; włókno szklane, silikon
Whisk; 18/10; vinyl

Nr kat.	l cm	wl	PLN	EUR
T-61524	25	6	43,61	-



de Buyer

Różga; 18/10, silikon
Whisk; 18/10; silicone

Nr kat.	l cm	thk mm	wl	PLN	EUR
D-2610-20	22	1,4	8	58,75	-
D-2610-25	25	1,4	8	73,19	-
D-2610-35	35	1,8	8	91,12	-
D-2610-40	40	1,8	8	103,75	-
D-2610-45	46	1,8	8	116,11	-
D-2610-50	50	1,8	8	131,47	-

Szczelny, ergonomiczny uchwyt o śr. 27 mm
Ergonomic, hermetic handle dia 27 mm



de Buyer

Różga sprężysta; 18/10, silikon
Whisk; 18/10; silicone

Nr kat.	l cm	thk mm	wl	PLN	EUR
D-2611-35	35	2	8	100,32	-
D-2611-45	45	2	8	122,95	-



Różga; 18/10
Whisk; 18/10

Nr kat.	l cm	thk mm	wl	PLN	EUR
T-823-25	25	2,2	12	13,83	-
T-823-30	30	3,3	8	16,67	-
T-823-35	35	2,2	12	17,91	-
T-823-40	40	3,3	8	20,38	-
T-823-50	50	3,3	8	25,32	-
T-823-60	60	3,3	8	30,26	-

Szczelny uchwyt o śr. 27 mm
Hermetic handle dia 27 mm



Chochla monoblok; 18/10
Monoblock Ladle; 18/10

Nr kat.	l cm	Ø cm	cap l	PLN	EUR
T-612-007	30	7	0,07	22,85	-
T-613-012	32	8	0,12	28,16	-
T-614-020	33	9	0,2	31,25	-
T-615-025	37	10	0,25	39,64	-
T-617-050	40	12	0,4	52,24	-
T-618-075	45	14	0,7	60,64	-
T-619-100	47	16	1	79,16	-

Bardzo solidna • Pojemność wytłoczona na uchwycie
Robust • The capacity embossed on the handle



Chochla; 18/10
Ladle; 18/10

Nr kat.	Ø cm	l cm	w cm	cap l	PLN	EUR
T-1968-18	18	75	18	1,5	211,24	-
T-1968-20	20	75	20	2	249,03	-

Uchwyt wykonany z ergonomicznej rurki • Bardzo solidna
Hollow pipe, ergonomic handle • Robust



Chochla; 18/10
Ladle; 18/10

Nr kat.	Ø cm	l cm	cap l	PLN	EUR
T-1301-02	9	40	0,2	19,38	-



Chochla; 18/10
Ladle; 18/10

Nr kat.	Ø cm	l cm	PLN	EUR
T-5550-006	8,5	31	43,94	-



Chochla; poliamid
Ladle; polyamide

Nr kat.	Ø cm	l cm	cap ml	PLN	EUR
T-6910-1	10	27	230	40,21	-
T-7012	12	40	350	57,17	-

Odporna na temp. do 220°C
Max. Temp. 220°C



Łyżka; poliamid
Spoon; polyamide

Nr kat.	l cm	w cm	PLN	EUR
T-2015	35 / 12,5	7,5	14,22	-

Odporna na temp. do 220°C
Max. temp. 220°C



Łyżka; drewno
Spoon; wood

Nr kat.	l cm	w cm	PLN	EUR
T-33235	25 / 9	5,5	7,28	-
T-33236	30 / 9	5,5	7,80	-
T-33237	35 / 9	5,5	9,08	-
T-33238	40 / 9	5,5	10,12	-



Łyżka do serwowania; 18/10
Serving spoon; 18/10

Nr kat.	l cm	w cm	PLN	EUR
T-1304-40	40 / 10	6,8	25,23	-



Łyżka do serwowania; 18/10
Serving spoon; 18/10

Nr kat.	l cm	w cm	PLN	EUR
T-5550-001	30,5 / 9	6,5	50,35	-



Łyżka nabierakowa; 18/10
Serving/sauce spoon; 18/10

Nr kat.	l cm	cap l	PLN	EUR
D-3982-10	37	0,075	44,80	-



Widelec do serwowania; 18/10
Serving fork; 18/10

Nr kat.	l cm	w cm	PLN	EUR
T-7821	32	2,5	42,28	-



Widelec do mięsa; 18/10
Meat fork; 18/10

Nr kat.	l cm	PLN	EUR
T-1302-40	40	25,69	-



Widelec do mięsa; 18/10
Meat fork; 18/10

Nr kat.	l cm	PLN	EUR
T-5550-002	33	33,73	-



Widelec do mięsa; 18/10, drewno
Meat fork; 18/10, wood

Nr kat.	l cm	w cm	PLN	EUR
T-212-155	15,5	2	8,40	-



Łyżka do spaghetti; 18/10
Spaghetti spoon; 18/10

Nr kat.	l cm	w cm	PLN	EUR
T-1306-40	40 / 8,5	7	24,82	-



Łyżka do spaghetti; 18/10
Spaghetti spoon; 18/10

Nr kat.	l cm	w cm	PLN	EUR
T-5550-003	28 / 7,5	6	44,65	-



Łyżka do spaghetti; poliamid
Spaghetti spoon; polyamide

Nr kat.	l cm	w cm	PLN	EUR
T-2013	33,4 / 9	6,5	14,22	-

Odporna na temp. do 220°C
Max. temp. 220°C



Cedzak siatkowy; 18/10
Skimmer; 18/10

Nr kat.	Ø cm	l cm	PLN	EUR
T-2640-16	16	55,5	35,44	-
T-2640-20	20	60	43,47	-
T-2640-24	24	62	50,14	-



Łyżka cedzakowa; 18/10
Skimmer; 18/10

Nr kat.	Ø cm	l cm	PLN	EUR
T-463-10	10	40	26,68	-
T-463-12	12	48	33,96	-
T-463-14	14	50,5	46,44	-
T-463-16	16	53,5	57,80	-
T-463-20	20	57	76,57	-

Perforacja 3 mm, przy śr. 20 cm - 4 mm
Perforation 3 mm, size ø 20 cm - 4 mm



Łyżka cedzakowa; 18/10
Skimmer; 18/10

Nr kat.	Ø cm	l cm	PLN	EUR
T-1307-40	10	40	23,47	-



Łyżka cedzakowa; poliamid
Skimmer; polyamide

Nr kat.	Ø cm	l cm	PLN	EUR
T-2005	11	35	15,02	-

Odporna na temp. do 220°C
Max. temp. 220°C



Łyżka perforowana; 18/10
Perforated serving spoon; 18/10

Nr kat.	l cm	w cm	PLN	EUR
T-1303-40	40 / 10,5	7	21,98	-



Łyżka perforowana; poliamid
Perforated spoon; polyamide

Nr kat.	l cm	w cm	PLN	EUR
T-2012	35 / 11,5	7,5	14,22	-

Odporna na temp. do 220°C
Max. temp. 220°C



Szumówka; 18/10
Skimmer; 18/10

Nr kat.	l cm	w cm	PLN	EUR
T-5550-004	33 / 9	11	39,43	-



Separator tłuszczu; PC
Fat separator; PC

Nr kat.	h cm	cap l	PLN	EUR
T-6000	12,5	1	48,93	-



Karbonowa, ergonomiczna rękojeść | Ergonomic, carbon handle



Łopátka trójkątna; 18/10, karbon
Spatula; 18/10, carbon

Nr kat.	l cm	w cm	PLN	EUR
D-4233-01	8	8	81,74	-

Ostra krawędź
Sharp edge



Łopátka giętka; 18/10, karbon
Flexible spatula; 18/10, carbon

Nr kat.	l cm	w cm	PLN	EUR
D-4235-00	21	7,8	92,68	-



Łopátka wygięta; 18/10, karbon
Spatula; 18/10, carbon

Nr kat.	l cm	w cm	PLN	EUR	
D-4232-00	12	9	95,42	-	
D-4232-01	perforowana	12	9	102,26	-



Łopátka prosta; 18/10, karbon
Spatula; 18/10, carbon

Nr kat.	l cm	w cm	PLN	EUR	
D-4236-00	16	5	88,58	-	
D-4236-01	perforowana	16	5	90,63	-



Łopátka; 18/10, karbon
Spatula; 18/10, carbon

Nr kat.	l cm	w cm	PLN	EUR
D-4230-15	15	3,5	78,32	-
D-4230-30	30	3,5	109,10	-



Łopátka; 18/10, karbon
Spatula; 18/10, carbon

Nr kat.	l cm	w cm	PLN	EUR
D-4231-15	15	3,5	78,66	-
D-4231-30	30	3,5	109,10	-



Łopátka; 18/10, karbon
Spatula; 18/10, carbon

Nr kat.	l cm	w cm	PLN	EUR
D-4231-09	9	2,4	68,06	-



Łopátka; 18/10, karbon
Spatula; 18/10, carbon

Nr kat.	l cm	w cm	PLN	EUR
D-4231-08	8	2	66,69	-



Nóż do biszkoptów; 18/10, karbon
Cake knife; 18/10, carbon

Nr kat.	l cm	w cm	PLN	EUR
D-4234-25	25	3,5	105,68	-
D-4234-35	35	3,5	112,52	-

Łatwo kroi biszkopt na warstwy
Easily cuts the cake in to the parts



100%Chef

Zestaw mini szpatuł; 18/10
Mini spatulas set (3pcs); 18/10

Nr kat.	PLN	EUR
C1-P6470	188,83	-

Zawiera: szpatułę (19cm), płaski widelec (19cm), łopátkę (17cm)
The set: spatula (17 and 19cm), flat fork (19cm)





Łopátka do smażenia; 18/10
Spatula; 18/10

Nr kat.	l cm	PLN	EUR
T-61413	52	58,14	-

Perforacja 3 mm
Perforation 3 mm



Łopátka do przewracania; 18/10
Turning spatula; 18/10

Nr kat.	l cm	PLN	EUR
T-1308-40	40	22,23	-



Łopátka do przewracania; 18/10
Turning spatula; 18/10

Nr kat.	l cm	PLN	EUR
T-5550-007	32	39,43	-



Łopátka do ryb / frytek; poliamid
Fish spatula; polyamide

Nr kat.	l cm	PLN	EUR
T-2115	35	42,15	-

Odporna na temp. do 220°C
Max. Temp. 220°C



Łopátka do ryb; 18/10
Spatula for fish; 18/10

Nr kat.	l cm	PLN	EUR
T-1985-34	34	71,22	-

Perforacja 3,5 mm
Perforation 3,5 mm



Łopátka do patelni non-stick perforowana;
poliamid
Perforated spatula for non-stick pans; polyamide

Nr kat.	l cm	PLN	EUR
T-2016 <i>perforowana</i>	30	10,37	-
T-2014	32	14,22	-

Odporna na temp. do 220°C
Max temp. 220°C



Łopátka do patelni non-stick; poliamid
Spatula for non-stick pans; polyamide

Nr kat.	l cm	PLN	EUR
T-2010	35	15,02	-
T-2011 <i>perforowana</i>	35	14,22	-

Odporna na temp. do 220°C
Max temp. 220°C



Łopátka powlekana; 18/10, poliamid
Spatula; 18/10, polyamide

Nr kat.	l cm	PLN	EUR
T-966-320	32	32,30	-

Odporna na temp. do 220°C
Max. Temp. 220°C



Łopátka; 18/10, PP
Spatula; 18/10, PP

Nr kat.	l cm	w cm	PLN	EUR
MG-STP10	19	12	118,43	-
MG-STP11	15	14,5	106,27	-





Szpachelka; 18/10, drewno
Spatula; 18/10, wood

Nr kat.	l cm	w cm	PLN	EUR
T-208-11	11	10	12,46	-



Łopatką do steków; 18/10, drewno
Steak spatula; 18/10, wood

Nr kat.	l cm	w cm	PLN	EUR
T-1001-5	18	11,3	22,11	-



Łopatką do steków; 18/10, drewno
Steak spatula; 18/10, wood

Nr kat.	l cm	w cm	PLN	EUR
T-1001-4	15	7,7	14,33	-



Łopatką do steków; 18/10, drewno
Steak spatula; 18/10, wood

Nr kat.	l cm	w cm	PLN	EUR
T-209-135	13,5	5,2	8,03	-



Łopatką do steków; 18/10, drewno
Steak spatula; 18/10, wood

Nr kat.	l cm	w cm	PLN	EUR
T-210-25	25	7,3	13,68	-



Nóż do masła; 18/10, drewno
Butter knife; 18/10, wood

Nr kat.	l cm	PLN	EUR
T-206-10	9	5,93	-



Łopatką; drewno
Spatula; wood

Nr kat.	l cm	w cm	PLN	EUR
T-33234	28	5	7,80	-

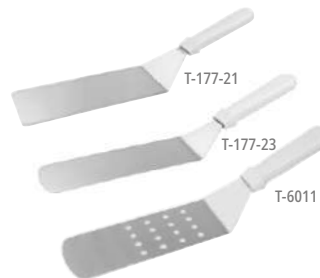

Łopatką do steków; 18/10, PP
Steak spatula; 18/10, PP

Nr kat.		l cm	w cm	PLN	EUR
T-177-21	prosta	20	10	21,86	-
T-177-23	zaokrąglona	20	7,2	11,98	-
T-6011	perforowana	20	7,6	11,98	-



Łopatką do steków; 18/10, PP
Steak spatula; 18/10, PP

Nr kat.	l cm	w cm	PLN	EUR
T-177-22	14	11,2	22,11	-



Łopatką do steków; 18/10, PP
Steak spatula; 18/10, PP

Nr kat.	l cm	w cm	PLN	EUR
T-177-28	18	7,3	11,98	-
T-6025	15,5	7,3	11,61	-



TOMGAST



Pinceta kuchenna; 18/0
Tweezer; 18/0

Nr kat.	l cm	PLN	EUR
T-80033	16	12,33	-
T-80034	21	15,70	-

TOMGAST



Pinceta kuchenna; 18/0
Tweezer; 18/0

Nr kat.	l cm	PLN	EUR
T-80035	21	17,55	-

TOMGAST



Pinceta kuchenna; 18/0
Tweezer; 18/0

Nr kat.	l cm	PLN	EUR
T-80036	30	25,92	-



Pinceta; nylon
Tweezers; nylon

Nr kat.	l cm	PLN	EUR
T-2295	29,5	9,94	-



Pinceta; 18/10
Tweezers; 18/10

Nr kat.	l cm	PLN	EUR
C1-P3407	14	37,41	-
C1-P3436	20	43,19	-
C1-P3443	powł. tytanowa 20	79,10	-

100%Chef

100%Chef



Pinceta do ości; 18/10
Bones tweezers; 18/10

Nr kat.	l cm	PLN	EUR
C1-P434	12	20,35	-

TOMGAST



Nóż kieszonkowy do testowania; stal Cr-Mo, 18/10
Pocket testing knife; Cr-Mo steel, 18/10

Nr kat.	l cm	PLN	EUR
T-7984-C	12	143,07	-



Szczypce do ości; 18/10
Bones tweezers; 18/10

Nr kat.	l cm	PLN	EUR
T-1950	15	59,14	-



Szczypce uniwersalne; 18/10, winyl
Universal tongs; 18/10, vinyl

Nr kat.	l cm	PLN	EUR
T-210-1	25	13,20	-
T-210-2	30,5	14,33	-

Bardzo wytrzymały monoblock
Robust monoblock

TOMGAST



Szczypce silikonowe; silikon, 18/0
Silicone tongs; silicone, 18/0

Nr kat.	l cm	PLN	EUR
T-80032	30	32,32	-

TOMGAST



Szczypce uniwersalne; 18/0
Food tongs; 18/0

Nr kat.	l cm	PLN	EUR
T-80038	23	11,01	-
T-80039	30	11,93	-
T-80040	40	14,04	-



Szczypce uniwersalne; 18/10
Universal tongs; 18/10

Nr kat.	l cm	PLN	EUR
T-21-25	24	13,46	-
T-21-30	30	15,31	-

Bardzo wytrzymały monoblock
Robust monoblock





Szczypce do patelni non-stick; 18/10, silikon
Tongs for non-stick pans; 18/10, silicone

Nr kat.	l cm	PLN	EUR
T-1512	34	31,64	-

Odporna na temp. do 200°C
Max. temp. 200°C



Szczypce uniwersalne do patelni non-stick; nylon
Universalongs for non-stick pans; nylon

Nr kat.	l cm	PLN	EUR
T-C15MI	28	16,74	-

Odporna na temp. do 220°C
Max. temp. 220°C



Szczypce do patelni non-stick; nylon
Tongs for non-stick pans; nylon

Nr kat.	l cm	PLN	EUR
T-C15MD	32	16,74	-

Odporna na temp. do 220°C
Max. temp. 220°C



Szczypce; 18/10
Tongs; 18/10

Nr kat.	l cm	PLN	EUR
T-211-230	23	21,61	-
T-211-300	30	24,70	-



Szczypce do spaghetti; 18/10
Spaghetti tongs; 18/10

Nr kat.	l cm	PLN	EUR
T-9600	20	16,41	-



Szczypce do pieczenia; 18/10
Roast tongs; 18/10

Nr kat.	l cm	PLN	EUR
T-9700	21	16,25	-



Szczypce do skorupiaków; stal
Pilers for shellfish; steel

Nr kat.	l cm	w cm	PLN	EUR
D-4685-00	20,7	6,5	76,95	-

Wygodny uchwyt • Demontowalne dla łatwego czyszczenia • Mechanizm zamykający
Comfortable grip • Detachable for easy cleaning • Locking mechanism



Rękawica ochronna; 18/10
Safety glove; 18/10

Nr kat.	PLN	EUR
T-9590-MF	527,35	-



Nóż do ostryg; 18/10, carbon
Oyster knife; 18/10, carbon

Nr kat.	l cm	PLN	EUR
D-4683-00	15,7	37,28	-

Antypoślizgowe, ergonomiczny chwyt
Anti-slip, ergonomic handle

de Buyer

de Buyer

TOMGAST



KUP ON-LINE





Otwieracz do konserw; tworzywo, 18/0
Can opener; plastic, 18/0

Nr kat.	l cm	w cm	PLN	EUR
T-80018	20	4,5	42,63	-



Wyciskacz do czosnku; tworzywo
Garlic press

Nr kat.	l cm	col	PLN	EUR
T-266-001	15	czarny	47,74	-

Bardzo łatwe czyszczenie • Jednoelementowy
Easy cleaning • One-piece



Krajalnica do masła; 18/10, Al
Butter cutter; 18/10, Al

Nr kat.	l cm	w cm	PLN	EUR
T-3200	26	8,3	71,44	-



Krajalnica do owoców; 18/10, Al
Fruit cutter; 18/10, Al

Nr kat.	Ø cm	l cm	PLN	EUR
T-5110	9	17	63,94	-



Krajalnica do jajek; 18/10, Al
Eggs cutter; 18/10, Al

Nr kat.	l cm	w cm	PLN	EUR
T-1020-1	13,5	7,5	60,80	-



Krajalnica do jajek; 18/10, Al
Eggs cutter; 18/10, Al

Nr kat.	Ø cm	l cm	PLN	EUR
T-1060	4	18	67,36	-

Kroi na 6 równych części
Cuts into 6 pcs.



Wieszak kuchenny; 18/10
Kitchen hanger; 18/10

Nr kat.	l cm	thk mm	PLN	EUR
T-1855	45,5	1,4	56,53	-

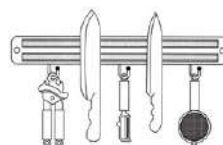

Listwa magnetyczna; tworzywo, stal
Magnetic strip; plastic, steel

Nr kat.	l cm	PLN	EUR
T-7987-045	45	28,41	-
T-7987-060	60	35,82	-

Listwy magnetyczne posiadają dodatkowo haczyki do zawieszania akcesoriów
The magnetic strips are additionally equipped with hooks for hanging accessories



Uchwyt na bony; 18/10
Bill bar; 18/10

Nr kat.	l cm	PLN	EUR
T-1001-006	60	68,17	-

BarEq



Szpikulec na bony; stal
Bills pin; steel

Nr kat.	Ø cm	h cm	PLN	EUR
T-1055	8	15,5	8,55	-

BarEq



Dzwonek
Ring

Nr kat.	h cm	PLN	EUR
T-10471	8,5	23,01	-





Otwieracz do konserw; stal
Can opener; steel

Nr kat.	h cm	PLN	EUR
T-WNNO	40	415,80	-
T-WNNOKZ	kółko zapasowe	52,80	-
T-WNNONZ	nożyk zapasowy	28,50	-

Regulowany, do puszek o wys. max. 35 cm i do blatów max. 5,5 cm grubości • Solidne wykonanie

Adjustable, for cans max. H 35 cm i do blatów max. 5,5 cm thick • Very robust



Krajalnica Julienne
Julienne cutter

Nr kat.	l cm	PLN	EUR
T-9475-3	18	215,65	-

Wyposażony w 3 ostrza wymienne: 3 mm, 6 mm i obieraczka

Equipped with 3 replaceable knives: julienne 3 mm, 6 mm and peeler



TOMGAST

Obieraczka do warzyw; stal węglowa, tworzywo
Peeler; carbon steel, plastic

Nr kat.	l cm	w cm	PLN	EUR
T-80022	12	5	21,97	-



TOMGAST

Obieraczka julienne; stal węglowa, tworzywo
Peeler julienne; carbon steel, plastic

Nr kat.	l cm	PLN	EUR
T-80020	17	19,53	-



TOMGAST

Obieraczka do warzyw; stal węglowa, tworzywo
Peeler; carbon steel, plastic

Nr kat.	PLN	EUR
T-80021	21,97	-



Skrobak do ryb; 18/10
Fish scraper; 18/10

Nr kat.	l cm	PLN	EUR
T-913400	21	13,30	-



WÜSTHOF

Obieraczka do warzyw
Peeler

Nr kat.	l cm	PLN	EUR
W-3071-7	18	22,61	-



Nóż do sera
Cheese knife

Nr kat.	l cm	col	PLN	EUR
T-9655SP15W	15	biały	25,75	-



Nóż do sera; 18/10, tworzywo
Cheese knife

Nr kat.	l cm	w cm	PLN	EUR
T-345-10	22	8	14,54	-

KUP ON-LINE



TOMGAST



Nożyczki do ziół; 18/0
Herbs scissors; 18/0

Nr kat.	l cm	PLN	EUR
T-80002	20	41,97	-

TOMGAST



Nożyczki kuchenne; stal węglowa, tworzywo
Kitchen scissors; carbon steel, plastic

Nr kat.	l cm	PLN	EUR
T-80001	21,5	35,32	-

KASUMI®



Nożyczki
Scissors

Nr kat.	l cm	PLN	EUR
K-81001	24	190,43	-



Nożyczki kuchenne; X50 Cr MoV 15
Kitchen scissors; X50CrMoV15

Nr kat.	l cm	PLN	EUR
W-1059594905	20,9	319,00	-



de Buyer®

Wydrążacz do warzyw i owoców; 18/10
Corer for fruits and vegetables; 18/10

Nr kat.	Ø cm	l cm	PLN	EUR
● D-2612-01	1,2	20,5	49,00	-
● D-2612-02	2	24	49,00	-
● D-2612-03	3	24	49,00	-

Antypoślizgowy uchwyt • Opatentowany system: wydrążanie do określonej głębokości
Anti-slip handle • Patented system: cores, tops and tails fruits/vegetables cleanly in a trice



Nożyk dekoracyjny do marchewki; 18/10, ABS
Decorating knife for carrots; 18/10

Nr kat.	l cm	PLN	EUR
T-5125	15	21,66	-

100%Chef



Mini szpatuła; 18/10
Mini spatula; 18/10

Nr kat.	l cm	PLN	EUR
C1-P6403	16	21,25	-



100%Chef

Wycinarka - owal i koło; 18/10
Decoration knife oval/circle; 18/10

Nr kat.	l cm	PLN	EUR
C1-P6496	20	64,44	-

Śr. koła: 1,3 cm; wym. owalu: 0,8 x 1,8 cm
Ring ø 1,3 cm; oval 0,8 x 1,8 cm



Spirala dekoracyjna do ziemniaków; 18/10
Decorating helix for potatoes; 18/10

Nr kat.	l cm	PLN	EUR
T-5122	24,5	22,61	-



Zestaw noży dekoracyjnych; 18/10
Carving knives set; 18/10

Nr kat.	PLN	EUR
T-8613	400,20	-



Nóż do obierania grejpfruta;
stal nierdzewna, tworzywo
Grapefruit peeler; SS, plastic

Nr kat.	l cm	PLN	EUR
T-80017	21	26,40	-



Nóż do cytrusów; stal nierdzewna, tworzywo
Citrus peeler; SS, plastic

Nr kat.	l cm	PLN	EUR
T-80019	17,5	22,17	-



Wydrążacz do jabłek; tworzywo, stal nierdzewna
Apple corer; plastic, SS

Nr kat.	l cm	PLN	EUR
T-80006	21,5	22,17	-



Nóż dekoracyjny, okrągły 22/25 mm; tworzywo,
stal nierdzewna
Melon baller 22/25 mm; plastic, SS

Nr kat.	Ø mm	l cm	PLN	EUR
T-80005	22/25	16,3	30,09	-



Zester; stal węglowa, tworzywo
Zester; carbon steel, plastic

Nr kat.	l cm	PLN	EUR
T-80007	15,5	24,87	-



Nóż dekoracyjny; stal nierdzewna, tworzywo
Decoration knife; SS, plastic

Nr kat.	l cm	PLN	EUR
T-80008	15,5	22,17	-



Wycinak do pomidorów; tworzywo,
stal nierdzewna
Tomato shark; plastic, SS

Nr kat.	Ø mm	l cm	PLN	EUR
T-80016	22	15	24,87	-





N

Tarka do przypraw; stal nierdzewna; tworzywo
Spice grater; stainless steel; plastic

Nr kat.	l cm	h cm	w cm	PLN	EUR
MC-46016	23	2,5	3	65,00	-



N

Tarka Ultra Coarse; stal nierdzewna; tworzywo
Ultra Coarse grater; stainless steel; plastic

Nr kat.	l cm	h cm	w cm	PLN	EUR
MC-45011	31	3	11,1	121,91	-



N

Mandolina Julienne; stal nierdzewna; tworzywo
Mandoline Julienne; stainless steel; plastic

Nr kat.	l cm	h cm	w cm	PLN	EUR
MC-45041	31	3	7,5	113,78	-



N

Tarka Star Blade; stal nierdzewna; tworzywo
Grater Star Blade; stainless steel; plastic

Nr kat.	l cm	h cm	w cm	PLN	EUR
MC-45009	31	3	7,5	113,78	-



N

Tarka Extra Coarse; stal nierdzewna; tworzywo
Extra Coarse grater; stainless steel; plastic

Nr kat.	l cm	h cm	w cm	PLN	EUR
MC-45008	31	3	7,5	113,78	-



N

Tarka Large Shaver; stal nierdzewna; tworzywo
Grater Large Shaver; stainless steel; plastic

Nr kat.	l cm	h cm	w cm	PLN	EUR
MC-45006	31	3	7,5	113,78	-



N

Tarka Fine; stal nierdzewna; tworzywo
Grater Fine; stainless steel; plastic

Nr kat.	l cm	h cm	w cm	PLN	EUR
MC-45004	31	3	7,5	113,78	-



N

Mandolina Fine Julienne; stal nierdzewna; tworzywo
Mandoline Fine Julienne; stainless steel; plastic

Nr kat.	l cm	h cm	w cm	PLN	EUR
MC-45003	31	3	7,5	113,78	-



N

Tarka Ribbon; stal nierdzewna; tworzywo
Grater Ribbon; stainless steel; plastic

Nr kat.	l cm	h cm	w cm	PLN	EUR
MC-45002	31	3	7,5	113,78	-



N

Tarka Coarse; stal nierdzewna; tworzywo
Coarse grater; stainless steel; plastic

Nr kat.	l cm	h cm	w cm	col	PLN	EUR
MC-45000	31	3	7,5	czarny	113,78	-



N

Rękawica ochronna
Protective glove

Nr kat.	col	PLN	EUR
MC-34027	szary	52,80	-

materiał: poliester, nylon, włókno szklane, elastan • bezszwowa • dla prawy i leworęcznych • rozmiar uniwersalny • można prać w pralce w temp. 60°C
material: polyester, nylon, elastane, glass fibre • seamless • for right and left handed • universal size • machine washable at temp. 60°C





Tarka Dual Blade - Coarse & Fine;
stal nierdzewna; tworzywo
Dual Blade Grater - Coarse & Fine; stainless steel; plastic



Nr kat.	l cm	h cm	w cm	PLN	EUR
MC-45022	31	3	11,1	121,91	-



Tarka czterościenna; stal nierdzewna; tworzywo
Four-sided grater; stainless steel; plastic



Nr kat.	l cm	h cm	w cm	PLN	EUR
MC-34006	13	27	8,5	186,95	-

trzy style ostrzy ścierających oraz jedno ostrze tnące
three styles of abrasive blades and one cutting blade



Młynek do przypraw
Spice Mill



Nr kat.	h cm	col	PLN	EUR
MC-48960	12	czarny	97,52	-

materiał: stal nierdzewna, tworzywo • przeznaczony do mielenia:
orzechów, gałki muskatowej, cynamonu, długiego pieprzu
material: stainless steel, plastic • suitable for grinding: nuts, nutmeg, cinnamon, long pepper

TOMGAST



Tarka, drobna; tworzywo, 18/10
Grater, fine edge; plastic, 18/10

Nr kat.	l cm	w cm	PLN	EUR
T-80011	22	3,5	39,66	-



Tarka, średnia; tworzywo, 18/10
Grater, medium edge; plastic, 18/10

Nr kat.	l cm	w cm	PLN	EUR
T-80013	22	3,5	39,66	-



Tarka, gruba; tworzywo, 18/10
Grater, coarse edge; plastic, 18/10

Nr kat.	l cm	w cm	PLN	EUR
T-80009	13	6	35,37	-



Tarka, drobna; tworzywo, 18/10
Grater, fine edge; plastic, 18/10

Nr kat.	l cm	w cm	PLN	EUR
T-80010	13	6	39,66	-



Tarka, średnia; tworzywo, 18/10
Grater, medium edge; plastic, 18/10

Nr kat.	l cm	w cm	PLN	EUR
T-80012	13	6	35,36	-



Tarka do cebuli; tworzywo, 18/10
Onion grater; plastic, 18/10

Nr kat.	l cm	w cm	PLN	EUR
T-80014	13	6	35,37	-



Tarka do ziemniaków; tworzywo, 18/10
Potato grater; plastic, 18/10

Nr kat.	l cm	w cm	PLN	EUR
T-80015	13	6	35,37	-



Mandolina do trufli; 18/10
Mandoline for truffles; 18/10

Nr kat.	l cm	w cm	PLN	EUR
T-2225	25,5	6	216,13	-

Regulowana grubość krojenia
Adjustable thickness of cutting



Tarka do gałki muszkatolowej; 18/10
Nutmeg grater; 18/10

Nr kat.	l cm	PLN	EUR
T-2270	15	16,53	-

Praktyczny wieszak • Możliwość przechowywania niestartych, całych gałek
With hook • Place to collect spear nutmegs



Tarka czterościenne; 18/10
Grater - 4 walls; 18/10

Nr kat.	h cm	PLN	EUR
T-8940	24	29,52	-



Moździerz; granit
Mortar; granite

Nr kat.	Ø cm	h cm	PLN	EUR
T-60516	16	12	126,45	-

Granit
Granite



Sitko do przypraw; 18/10
Cage for spices; 18/10

Nr kat.	Ø cm	PLN	EUR
T-3307	7,5	25,48	-

Dł. łańcuszka: 15 cm
The lenght of the chain: 15 cm



Szpryca do nadziewania; 18/10
Syringe; 18/10

Nr kat.	l cm	PLN	EUR
T-280	22	59,09	-



Sznurek
Twine

Nr kat.		PLN	EUR
D-4337-01	10 x rolka 45 g	94,55	-
D-4338-01	rolka 1 kg	188,10	-

Naturalny materiał odporny na zrywanie • Odporny na temp. od -40°C do +220°C • Bezpieczny dla żywności
High resistance to braking • Temp. from -40°C to +220°C • Suitable for direct contact with foodstuff

de Buyer



Igła do mięsa; 18/11
Needle for meet; 18/10

Nr kat.		l cm	PLN	EUR
T-1268	do szycia mięsa	18	14,25	-
T-1267	do faszzerowania	19	18,81	-



100%Chef



Forma z dociskaczem- walec; 18/10
Form with pusher - cylinder; 18/10

Nr kat.	Ø cm	h cm	PLN	EUR
C1-1225	4	8	113,32	-

100%Chef



Forma z dociskaczem- prostopadłością; 18/10
Form with pusher - cuboid; 18/10

Nr kat.	l cm	h cm	w cm	PLN	EUR
C1-1226	4	8	4	113,32	-



Więcej rantów na str. 167–170
See more pastry rings on pages 167–170



Dociskacz do rantu; 18/10
Pusher for ring; 18/10

Nr kat.	Ø cm	PLN	EUR
T-6956	6	11,09	-
T-6908	8	14,39	-
T-6910	10	17,58	-



Rant cukierniczy; 18/10
Pastry ring; 18/10

Nr kat.	Ø cm	h cm	thk mm	PLN	EUR
D-3989-06	6	6	1,5	19,19	-
D-3989-07	7	8	1,5	29,07	-
D-3989-08	8	6	1,5	25,66	-
D-3989-10	10	4,5	0,8	29,07	-
D-3940-12	12	6	0,8	37,62	-
D-3912-12	12	8	1	58,48	-

KUP ON-LINE



Mandolina Vantage; 18/10
Mandoline Vantage; 18/10

Nr kat.	Ø cm	l cm	h cm	w cm	PLN	EUR
D-2017-00		50		15	786,26	-
D-2015-84	dociskacz GRAVITY	5	14,5	10,5	75,58	-

Ostrze w kształcie V do cięcia nawet delikatnych owoców/warzyw • 4 ostrza Julienne 2, 4, 7, 10 mm
• Posiada schowek na akcesoria • Precyzyjna regulacja grubości cięcia • Ergonomiczny popychacz ułatwia przesuwanie warzyw • Nóżki antypoślizgowe

Integrated V-shaped blade to cut even the softest fruit/vegetable • 4 blades Julienne 2, 4, 7, 10 mm • Storage box • Exact adjustment of cutting thickness • Ergonomic protective pusher • Anti-slip feet



dociskacz
GRAVITY
D-2015-84

**Dociskacz do mandoliny Vantage; PP**
Puscher for mandolin Vantage; PP

Nr kat.	PLN	EUR
D-2017-55	151,51	-



dociskacz
GRAVITY
D-2015-84

Mandolina VIPER
Mandoline VIPER

Nr kat.	Ø cm	l cm	h cm	w cm	PLN	EUR
D-2016-00		41		21	581,06	-
D-2015-84	dociskacz GRAVITY	5	14,5	10,5	75,58	-

Możliwość krojenia w plastry, kostki i julienne • Ostrze typu V z mikro-ząbkami dla łatwiejszego krojenia nawet delikatnego produktu • Ergonomiczny dociskacz z kontrolą obrotów dla bezpiecznych i efektywnych ruchów • W zestawie 3 ostrza - standardowe, julienne 4 mm i julienne 10 mm • Nóżki antypoślizgowe • Precyzyjna regulacja grubości cięcia • DICE SYSTEM - funkcja służąca do krojenia w kostkę

Cuts slices, dices, diamonds and julienne 4,10 mm • Integrated V-shaped blade to cut even the softest fruit/vegetable • Ergonomic pusher and slider • 3 blades - horizontable and julienne 4 mm, 10 mm • Anti-slip feet • Exact adjustment of cutting thickness

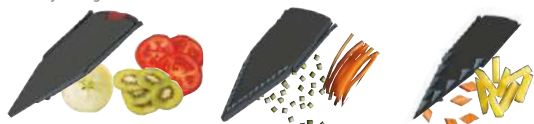

ostrze
Julienne 2-7
D-2015-93



dociskacz
GRAVITY
D-2015-84

Mandolina Swing Plus
Mandoline Swing Plus

Nr kat.	Ø cm	l cm	h cm	w cm	PLN	EUR
D-2015-03		40		20	392,96	-
D-2015-84	dociskacz GRAVITY	5	14,5	10,5	75,58	-
D-2015-93	ostrze Julienne 2-7				126,88	-

Mandolina pokryta powłoką antybakteryjną • W zestawie podwójne poziome ostrze (gładkie i faliste) oraz podwójne ostrze Julienne 4-10 mm • Precyzyjna regulacja grubości cięcia • Nowy, ergonomiczny popychacz • Nóżki antypoślizgowe

Light but robust polymer composite • One double horizontal blade - straight / serrated and double julienne blade 4-10 mm • Exact adjustment of cutting thickness • Ergonomic pusher • Anti-slip feet





Mandolina Revolution; 18/10
Mandoline Revolution; 18/10

Nr kat.	Ø cm	l cm	h cm	w cm	PLN	EUR
D-2012-01		39,5		19,5	786,26	-
D-2015-84	dociskacz GRAVITY	5	14,5	10,5	75,58	-

W zestawie podwójne poziome ostrze (gładkie i faliste) oraz 3 ostrza Julienne 2, 4, 10 mm • Precyzyjna regulacja grubości cięcia • Ergonomiczny popychacz obrotowy ze stali nierdzewnej • Nóżki antypoślizgowe

Complete with one double horizontal blade - straight / serrated and 3 julienne blades 2, 4, 10 mm • Exact adjustment of cutting thickness • Stainless steel protective pusher • Anti-slip feet



Mandolina Revolution Master z dodatkowymi akcesoriami
Mandoline Revolution Master with additional accessories

Nr kat.	Ø cm	l cm	h cm	w cm	PLN	EUR
D-2012-41		39,5		19,5	1 196,66	-
D-2015-84	dociskacz GRAVITY	5	14,5	10,5	75,58	-

W zestawie podwójne poziome ostrze (gładkie i faliste) oraz 6 ostrzy Julienne 2, 3, 4, 5, 7, 10 mm wraz z pudełkiem do przechowywania • Precyzyjna regulacja grubości cięcia • Ergonomiczny popychacz obrotowy ze stali nierdzewnej • Dodatkowy popychacz do podłużnych warzyw • Nóżki antypoślizgowe

Complete with one double horizontal blade - straight / serrated and 6 julienne blades 2, 3, 4, 5, 7, 10 mm together with storage box • Exact adjustment of cutting thickness • Stainless steel protective pusher • Extra - long pusher • Anti-slip feet



Mandolina japońska Komi; tworzywo
Japanese mandolin Komi; plastic

Nr kat.	l cm	h cm	w cm	PLN	EUR
D-2018-00	27	3,3	11,2	170,66	-

Poreczna i efektywna. Ostrze 35° • Cięcie: plastry & Julienne 2 mm, 4 mm • Precyzyjna regulacja grubości cięcia od 0 do 5 mm. • Ergonomiczny dociskacz • Kompaktowy pojemnik przechowujący ostrza Julienne i dociskacz

Accurate and efficient: sharp blade with its 35°-angle. Multicut: slices & Julienne 2 mm/4 mm (0.08/0.15 in.). Quick and easy thickness adjustment. Graduated from 0 up to 5 mm. Equipped with an ergonomic protective food guard made of transparent plastic. Compact storage: integrated Julienne blades storage box & food guard.



Szatkownica Kobra; 18/10, PP
Mandoline Kobra

Nr kat.	l cm	h cm	w cm	g	PLN	EUR
D-2011-01	36,5	8	12,2	660	256,16	-

Grubość krojenia od 0,2 mm do 5 mm • Ostrze typu V z mikro-ząbkami dla łatwiejszego krojenia nawet delikatnego produktu • Optymalny kąt krojenia 19.3° • Pokrętko grubości krojenia w uchwycie • Ergonomiczny, antypoślizgowy uchwyt • Popychacz zabezpiecza rękę przed skałeczeniem • Nóżki antypoślizgowe

Cut thickness from 0,2 mm to 5 mm • V - shaped blade to cut even the softest fruit/vegetable • Cutting angle 19.3° • Precise adjustment of height of the cut integrated at the end of the handle • Ergonomic, anti-slip handle • Ergonomic pusher • Anti-slip feet



TOMGAST

Noże TOM-GAST, produkowane w Niemczech, wyróżniają się znakomitą materiałem oraz doskonałym wykończeniem. Tradycyjnie do produkcji noży TOM-GAST, stosuje się te materiały i procesy, które zagwarantują, że produkt będzie ceniony przez użytkowników i ułatwi im profesjonalną pracę.

Produced in Germany, TOM-GAST knives are distinguished by excellent material and finish. The materials and processes which are always used in the production of TOM-GAST knives guarantee that the product will be valued by users and will facilitate their professional work.

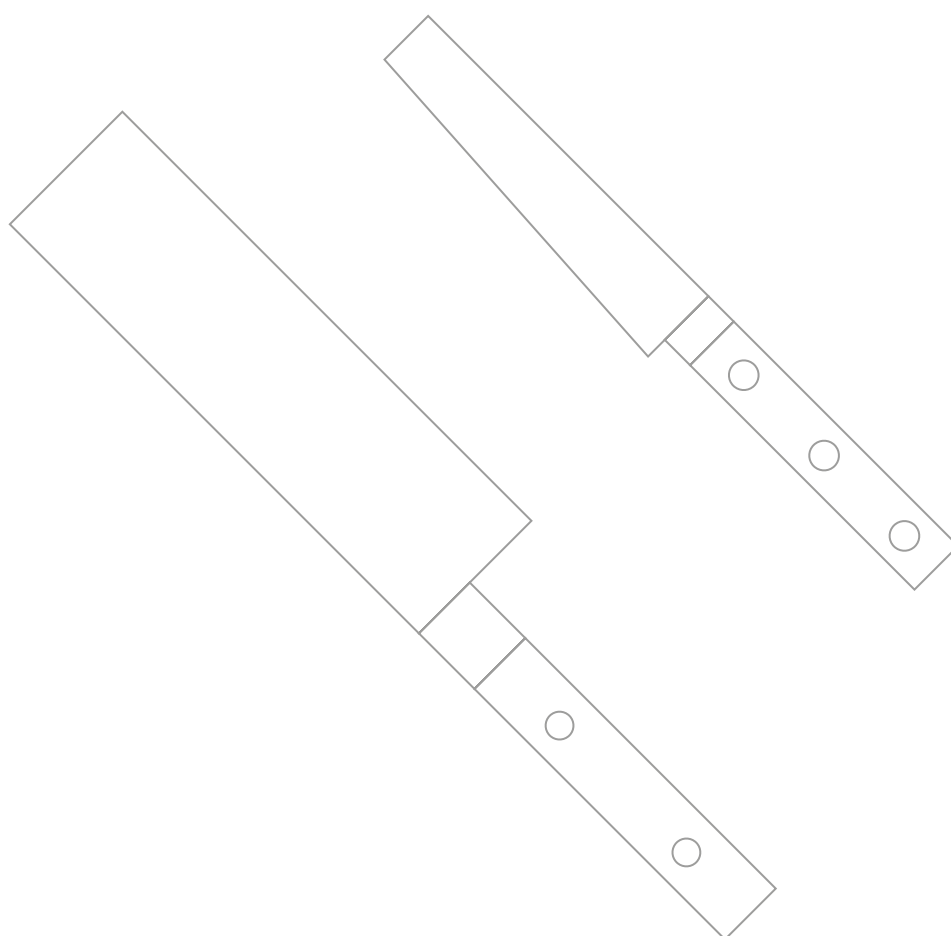

KUP ON-LINE



CrMo15

Ostrza noży Tom-Gast wykonane są z najwyższej jakości stali chromowo-molibdenowej CrMo15 i są hartowane do 56-57 HRC (skala Rockwella).

The blades of Tom-Gast knives are made of the highest quality CrMo15 chrome-molybdenum steel, hardened to 56-57 HRC (Rockwell scale).

Najnowocześniejszy i zaawansowany proces hartowania próżniowego zapewnia bardzo długą żywotność i niezwykłą ostrość noża.

The state-of-the-art and most advanced process of vacuum hardening ensures a very long life and remarkable sharpness of the blade.

Prime Line to ergonomiczne uchwyty z wykończeniem Sanitized® Silver - zawierają jony srebra, które niezawodnie redukują rozprzestrzenianie się bakterii.

Prime Line handles have a Sanitized® Silver finish - containing silver ions, which reliably reduce the spread of bacteria.



Nóż szefa kuchni; stal Cr-Mo
Chef's knife; Cr-Mo steel

Nr kat.	l cm	col	PLN	EUR
T-2500-20	20	czarny	98,80	-



Nóż szefa kuchni; stal Cr-Mo
Chef's knife; Cr-Mo steel

Nr kat.	l cm	col	PLN	EUR
T-2500-23	23	czarny	111,91	-



Nóż kuchenny; stal Cr-Mo
Utility knife; Cr-Mo steel

Nr kat.	l cm	col	PLN	EUR
T-2600-18	18	czarny	92,44	-



Nóż santoku perforowany; stal Cr-Mo
Santoku knife; Cr-Mo steel

Nr kat.	l cm	col	PLN	EUR
T-2900-19	19	czarny	167,01	-



Nóż do filetowania; stal Cr-Mo
Fillet knife; Cr-Mo steel

Nr kat.	l cm	col	PLN	EUR
T-2500-16	16	czarny	92,43	-



Nóż do pieczywa; stal Cr-Mo
Bread knife; Cr-Mo steel

Nr kat.	l cm	col	PLN	EUR
T-2500-25	25	czarny	118,85	-



Nóż do trybowania / masarski; stal Cr-Mo
Boning Knife; Cr-Mo steel

Nr kat.	l cm	col	PLN	EUR
T-12250-13	13	czarny	61,85	-



Nóż do trybowania / masarski; stal Cr-Mo
Boning Knife; Cr-Mo steel

Nr kat.	l cm	col	PLN	EUR
T-12250-15	15	czarny	72,96	-



Nóż do trybowania / masarski; stal Cr-Mo
Boning knife; Cr-Mo steel

Nr kat.	l cm	PLN	EUR
T-2100-15	15	84,84	-

Szlif kulowy ułatwia cięcie dzięki powietrznym poduszkom pomiędzy ostrzem, a ciałem mięsem - idealne cięcie wymaga znacznie mniej wysiłku
The hollow edge creates pockets of air which prevent extra thin or soft slices from sticking to the blade

KUP ON-LINE



Nóż uniwersalny, ząbkowane ostrze; stal Cr-Mo
Utility knife, serrated blade; Cr-Mo steel

Nr kat.	l cm	PLN	EUR
T-2500-11	11	31,13	-



Nóż do warzyw; stal Cr-Mo
Vegetable knife; Cr-Mo steel

Nr kat.	l cm	col	PLN	EUR
T-2500-10	10	czarny	31,13	-
T-2500-8	8	czarny	28,50	-



Nóż do oczkowania; stal Cr-Mo
Peeling knife; Cr-Mo steel

Nr kat.	l cm	col	PLN	EUR
T-2500-6	6	czarny	27,84	-



Nóż szefa kuchni; stal Cr-Mo
Chef's knife; Cr-Mo steel

Nr kat.	l cm	col	PLN	EUR
T-8500-20	20	czarny	77,62	-
T-8500-20GR	20	zielony	77,62	-
T-8500-20R	20	czerwony	77,62	-
T-8500-26	26	czarny	100,32	-
T-8500-26GR	26	zielony	100,32	-
T-8500-26R	26	czerwony	100,32	-



Nóż kuchenny; stal Cr-Mo
Utility knife; Cr-Mo steel

Nr kat.	l cm	col	PLN	EUR
T-8600-20	20	czarny	68,50	-



Nóż santoku; stal Cr-Mo
Santoku knife; Cr-Mo steel

Nr kat.	l cm	col	PLN	EUR
T-8269WWLK-18	18	czarny	102,98	-



Nóż do kebaba; stal Cr-Mo
Kebab knife; Cr-Mo steel

Nr kat.	l cm	col	PLN	EUR
T-7500-45	45	czarny	250,61	-



Nóż do pieczywa; stal Cr-Mo
Bread knife; Cr-Mo steel

Nr kat.	l cm	col	PLN	EUR
T-8500-24	24	czarny	83,41	-



Nóż kuchenny / masarski; stal Cr-Mo
Utility knife; Cr-Mo steel

Nr kat.	l cm	col	PLN	EUR
T-3500-18R	18	czerwony	79,42	-
T-3500-21	21	czerwony	91,68	-



Nóż masarski; stal Cr-Mo
Butcher knife; Cr-Mo steel

Nr kat.	l cm	col	PLN	EUR
T-4500-24R	24	czerwony	110,01	-



Nóż masarski; stal Cr-Mo
Breaking knife; Cr-Mo steel

Nr kat.	l cm	col	PLN	EUR
T-2005WWL-20	20	czarny	129,39	-



Nóż masarski; stal Cr-Mo
Breaking knife; Cr-Mo steel

Nr kat.	l cm	col	PLN	EUR
T-2005-20	20	czarny	112,67	-



Nóż do trybowania / masarski; stal Cr-Mo
Boning Knife; Cr-Mo steel

Nr kat.	l cm	col	PLN	EUR
T-2505-13	13	czarny	61,85	-
T-2505-15	15	czarny	72,96	-



Nóż do trybowania / masarski; stal Cr-Mo
Boning knife; Cr-Mo steel

Nr kat.	l cm	col	PLN	EUR
T-3500-16R	16	czerwony	61,18	-



Nóż uniwersalny; stal Cr-Mo
Utility knife; Cr-Mo steel

Nr kat.	l cm	col	PLN	EUR
T-8500-8GR	8	zielony	16,76	-
T-8500-8	8	czarny	16,15	-
T-8500-10	10	czarny	17,29	-
T-8500-10GR	10	zielony	17,29	-
T-8500-12	12	czarny	20,62	-



Nóż uniwersalny; stal Cr-Mo
Utility knife; Cr-Mo steel

Nr kat.	l cm	col	PLN	EUR
T-8500-11GR	11	zielony	18,19	-
T-8500-11	11	czarny	17,29	-
T-8500-11R	11	czerwony	17,29	-





Nóż do warzyw; stal Cr-Mo
Vegetable knife; Cr-Mo steel

Nr kat.	l cm	col	PLN	EUR
T-8305-8	8	czarny	16,15	-
T-8305-8GR	8	zielony	16,15	-



Nóż do oczkowania; stal Cr-Mo
Peeling knife; Cr-Mo steel

Nr kat.	l cm	col	PLN	EUR
T-8500-6GR	6	zielony	16,76	-
T-8500-6	6	czarny	16,15	-



Nóż do filetowania; stal Cr-Mo
Fillet knife; Cr-Mo steel

Nr kat.	l cm	col	PLN	EUR
T-3100-15	15	czarny	60,42	-



Nóż do filetowania; stal Cr-Mo
Fillet knife; Cr-Mo steel

Nr kat.	l cm	col	PLN	EUR
T-7500-16G	16	żółty	70,40	-



Nóż do filetowania; stal Cr-Mo
Fillet knife; Cr-Mo steel

Nr kat.	l cm	col	PLN	EUR
T-8500-31B	31	niebieski	124,26	-



Stalka diamentowa; stal stopowa, PP
Diamond sharpening steel; steel, PP

Nr kat.	l cm	PLN	EUR
T-80003	30,5	130,41	-



N

Nóż szafa kuchni; stal nierdzewna
Chef's knife; stainless steel

Nr kat.	l cm	PLN	EUR
T-10120	20	52,54	-



N

Nóż szafa kuchni; stal nierdzewna
Chef's knife; stainless steel

Nr kat.	l cm	PLN	EUR
T-10125	25	65,08	-



N

Nóż uniwersalny; stal nierdzewna
Utility knife; stainless steel

Nr kat.	l cm	PLN	EUR
T-10215	15	43,82	-



N

Nóż uniwersalny; stal nierdzewna
Utility knife; stainless steel

Nr kat.	l cm	PLN	EUR
T-10220	20	48,05	-



N

Nóż do pieczywa; stal nierdzewna
Bread knife; stainless steel

Nr kat.	l cm	PLN	EUR
T-10020	25	48,05	-



N

Nóż do trybowania; stal nierdzewna
Boning knife; stainless steel

Nr kat.	l cm	PLN	EUR
T-10315	15	37,62	-



N

Nóż do warzyw; stal nierdzewna
Vegetable knife; stainless steel

Nr kat.	l cm	PLN	EUR
T-10009	9	25,08	-



N

Nóż do oczkowania; stal nierdzewna
Peeling knife; stainless steel

Nr kat.	l cm	PLN	EUR
T-10007	7	24,95	-



N

Stalka; stal węglowa
Sharpening; carbon steel

Nr kat.	l cm	PLN	EUR
T-20025	25	34,19	-





Fabryka WÜSTHOF, została założona ponad 200 lat temu w Niemczech. Logo marki - „trójząb”, symbolizuje trzy wartości: pasję, pracowitość, doskonałość. Wüsthof to najwyższej jakości noże kute oraz ze stali walcowanej. Do produkcji noży używana jest stal chromowo-molibdenowo-wanadowa X50CrMoV15 zapewniająca optymalny balans między odpornością na korozję, twardością, a giętkością.

The WÜSTHOF family company was founded over 200 years ago in Germany. The brand's logo - „trident” - symbolizes three values: passion, diligence, perfection. The offer includes knives of the highest quality both forged and rolled steel. For the production of knives, X50CrMoV15 chrome-molybdenum-vanadium steel is used to ensure an optimal balance between corrosion resistance, hardness and flexibility.

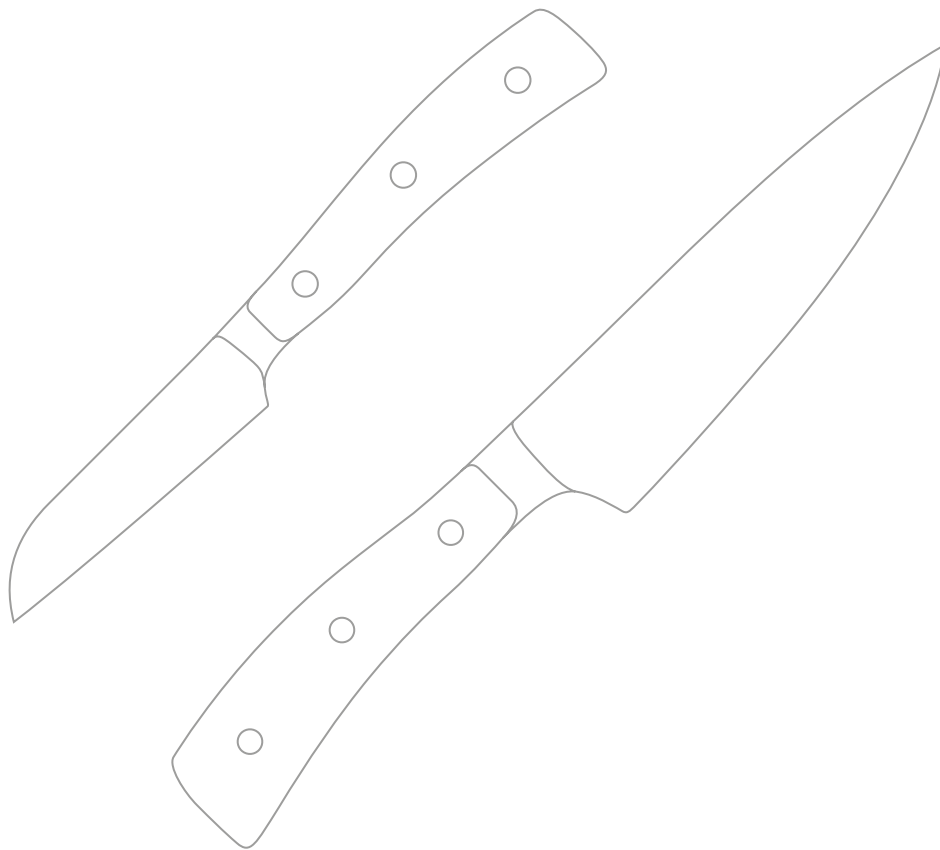

Rodzaje noży/types of knives

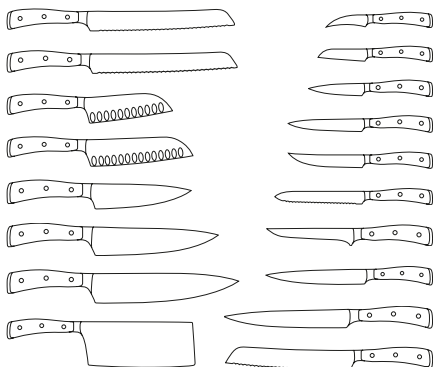

TECHNOLOGIA PEtec

Dzięki opatentowanemu procesowi laserowego ostrzenia noży: Precision Edge - PEtec, WÜSTHOF zapewnia gładszą, bardziej wyrafinowaną krawędź ze zwiększoną ostrością i zachowaniem jej na całej długości ostrza.

Thanks to the patented laser process of knife sharpening: Precision Edge - PEtec, WÜSTHOF provides a smoother, more sophisticated edge with increased sharpness and edge retention over the entire length of the blade.



Dbalność o środowisko

Metody produkcji są stale optymalizowane, aby zwiększyć efektywność energetyczną i wykorzystanie surowców, a także wyeliminować zanieczyszczenie ściekami i zmniejszyć emisję CO² i innych gazów cieplarnianych.

Production methods are constantly optimized to increase energy efficiency and the use of resources, as well as to eliminate sewage pollution and reduce emissions of CO² and other greenhouse gases

WÜSTHOF AMICI



Ostrze noży **AMICI** są kute z jednego kawałka stali hartowanej do 58 ° Rockwell. Technologia Precision Edge (PEtec) zapewnia o 20% ostrzejszą krawędź. Każda rękojeść jest niepowtarzalna dzięki rysunkowi drewna oliwnego a dodatkowo ma właściwości wodoodporne i antybakteryjne.

AMICI knife blades are forged from a single piece of 58 ° Rockwell hardened steel. Precision Edge (PEtec) technology provides a 20% sharper edge. Each handle is unique thanks to the olive wood pattern and additionally has waterproof and antibacterial properties.

WÜSTHOF IKON



Seria idealnie dopasowana do wymagań profesjonalnych kucharzy. Ekstremalna precyzja, doskonała ergonomia, wysoka jakość przeznaczona do intensywnej codziennej pracy. Każdy nóż posiada ergonomiczną rękojeść (full tang) wykonaną z niezwykle twardego, pochodzącego z Mozambiku, drewna Grenadill. Ostrza wykute są z najwyższej jakości stali WÜSTHOF, szlifowane są ręcznie przez mistrzów rzemiosła.

A series ideally suited to the requirements of professional chefs. Extreme precision, perfect ergonomics, high quality designed for intensive daily work. Each knife has an ergonomic full-tang handle made of extremely hard, Mozambique, Grenadill wood. The blades are forged from the highest quality WÜSTHOF steel, hand polished by masters of craftsmanship.

WÜSTHOF CLASSIC IKON



Łączy idealną ergonomię, doskonałą równowagę, rękojeści o ponadczasowym wzornictwie z niebywałą ostrością noża. Ostrze wykute jest ze specjalistycznej stali chromowo-molibdenowo-wanadowej X50CrMoV15 o twardości 58 HRC. Rękojeść wykonana jest z bardzo wytrzymałego syntetycznego materiału w kolorze czarnym i została zespolona z ostrzem za pomocą nitów ze stali nierdzewnej.

It combines perfect ergonomics and balance, handles with a timeless design with the incredible sharpness of the knife. The blade is forged from a special chromium-molybdenum-vanadium steel X50CrMoV15 with a 58 HRC openness. The handle is made of a very durable synthetic material in black and has been joined to the blade with stainless steel rivets.

WÜSTHOF CLASSIC



Classic – solidne, ostre i funkcjonalne – najbardziej klasyczne kute noże kuchenne. Dostępne są w wariantach z brodą (zapewniającą wyjątkowy balans) oraz bez brody dzięki czemu znacząco wydłużono ich żywotność. Korpusy noży wykonano ze stali chromowo-molibdenowo-wanadowej o twardości 58 HRC i ostrzono wykorzystując laserową technologię Precision Edge (PEtec).

Classic - solid, sharp and functional - the most classic forged kitchen knives. They are available in variants with a bolster (providing exceptional balance) and without a bolster, which significantly extends their lifespan. The knife bodies are made of chromium-molybdenum-vanadium steel with a hardness of 58 HRC and sharpened using the Precision Edge (PEtec) laser technology.

WÜSTHOF CLASSIC IKON Crème



Łączy idealną ergonomię, doskonałą równowagę, rękojeść o ponadczasowym wzornictwie z niebywałą ostrością noża. Rękojeść wykonana jest z bardzo wytrzymałego syntetycznego materiału. Noże są trwale nitowane, dzięki czemu są całkowicie higieniczne i łatwe w użyciu. Są polecane do codziennego użytkowania zarówno w kuchniach domowych, jak i profesjonalnych. Dzięki uchwytom w kolorze kremowym noże serii **CLASSIC IKON Crème** przyciągają wzrok w każdej profesjonalnej kuchni.

*It combines perfect ergonomics and balance, also a timeless handle design with extreme knife sharpness. The handle is made of a very durable synthetic material. The knives are permanently riveted, making them completely hygienic and easy to use. They are recommended for everyday use both at homes and in professional kitchens. The cream-colored handles make the **CLASSIC IKON Crème** an eye-catcher in any professional kitchen.*

WÜSTHOF GOURMET



Dzięki niezwykle wysokiej twardości (56° HRC) walcowanej, laserowo ciętej stali chromowo-molibdenowo-wanadowej są porównywalne twardością oraz jakością wykończenia do noży kutych. Dzięki mniejszej wadze i wyjątkowej ergonomii są bardzo wygodne w trzymaniu. Uchwyty wykonane ze specjalnego materiału syntetycznego, są nitowane do ostrza w dwóch lub trzech miejscach.

Due to the extremely high hardness (56 ° HRC) of the rolled, laser cut chrome-molybdenum-vanadium steel, they are comparable in hardness and quality of finish to forged knives. Thanks to their lower weight and unique ergonomics, they are very comfortable to hold. The handles are made of a special synthetic material and are riveted to the blade in two or three places.





Nóż do warzyw; X50CrMoV15
Vegetable knife; X50CrMoV15

Nr kat.	l cm	PLN	EUR
W-1011300409	9	652,07	-



Nóż do steków; X50CrMoV15
Steak knife; X50CrMoV15

Nr kat.	l cm	PLN	EUR
W-1011301712	12	652,07	-



Nóż uniwersalny z ząbkowaym ostrzem; X50CrMoV15
Utility knife with serrated blade; X50CrMoV15

Nr kat.	l cm	PLN	EUR
W-1011301614	14	733,47	-



Nóż do chleba; X50CrMoV15
Bread knife; X50CrMoV15

Nr kat.	l cm	PLN	EUR
W-1011301123	23	979,47	-



Nóż szefa kuchni; X50CrMoV15
Chefs knife; X50CrMoV15

Nr kat.	l cm	PLN	EUR
W-1011300116	16	815,77	-



Nóż szefa kuchni; X50CrMoV15
Chefs knife; X50CrMoV15

Nr kat.	l cm	PLN	EUR
W-1011300120	20	897,16	-



Nóż santoku ze szlifem kulowym;
X50CrMoV15
Santoku knife; X50CrMoV15

Nr kat.	l cm	PLN	EUR
W-1011331317	17	897,16	-



Nóż do oczkowania; X50CrMoV15
Paring knife; X50CrMoV15

Nr kat.	l cm	PLN	EUR
W-1010532207	7	508,27	-



Nóż uniwersalny z ząbkowym ostrzem; X50CrMoV15
Utility knife with serrated blade; X50CrMoV15

Nr kat.	l cm	PLN	EUR
W-1010531614	14	633,98	-



Nóż do steków; X50CrMoV15
Steak knife; X50CrMoV15

Nr kat.	l cm	PLN	EUR
W-1010531712	12	508,27	-



Nóż szefa kuchni; X50CrMoV15
Chefs knife; X50CrMoV15

Nr kat.	l cm	PLN	EUR
W-1010530116	16	690,96	-
W-1010530120	20	771,54	-



Nóż santoku; X50CrMoV15
Santoku knife; X50CrMoV15

Nr kat.	l cm	PLN	EUR
W-1010531317	17	690,24	-



Nóż chińskiego szefa kuchni; X50CrMoV15
Chinese chef knife; X50CrMoV15

Nr kat.	l cm	PLN	EUR
W-1010531818	18	1 141,35	-





Nóż do oczkowania; X50CrMoV15
Paring knife; X50CrMoV15

Nr kat.	l cm	PLN	EUR
W-1040332207	7	342,77	-



Nóż do warzyw; X50 Cr MoV 15
Vegetable knife; X50 Cr MoV 15

Nr kat.	l cm	PLN	EUR
W-1040330409	9	342,77	-



Nóż do warzyw; X50 Cr MoV 15
Vegetable knife; X50 Cr MoV 15

Nr kat.	l cm	PLN	EUR
W-1040330412	12	387,99	-



Nóż do pomidorów/cytrusów; X50 Cr MoV 15
Tomato / citrus knife; X50 Cr MoV 15

Nr kat.	l cm	PLN	EUR
W-1040331914	14	435,02	-



Nóż do trybowania; X50 Cr MoV 15
Boning knife; X50 Cr MoV 15

Nr kat.	l cm	PLN	EUR
W-1040331414	14	425,07	-



Nóż do filetowania; X50 Cr MoV 15
Filleting knife; X50 Cr MoV 15

Nr kat.	l cm	PLN	EUR
W-1040333716	16	432,30	-





Nóż do chleba; X50 Cr MoV 15
Bread knife; X50 Cr MoV 15

Nr kat.	l cm	PLN	EUR
W-1040331123	23	566,15	-



Nóż super slicer; X50CrMoV15
Super slicer knife; X50CrMoV15

Nr kat.	l cm	PLN	EUR
W-1040333126	26	551,68	-



Nóż szefa kuchni; X50 Cr MoV 15
Chef's knife; X50 Cr MoV 15

Nr kat.	l cm	PLN	EUR
W-1040330116	16	455,82	-



Nóż szefa kuchni; X50 Cr MoV 15
Chef's knife; X50 Cr MoV 15

Nr kat.	l cm	PLN	EUR
W-1040330123	23	566,15	-



Nóż szefa kuchni; X50 Cr MoV 15
Chef's knife; X50 Cr MoV 15

Nr kat.	l cm	PLN	EUR
W-1040330120	20	563,44	-



Nóż uniwersalny; X50 Cr MoV 15
Utility knife; X50 Cr MoV 15

Nr kat.	l cm	PLN	EUR
W-1040330716	16	436,83	-



Nóż uniwersalny; X50 Cr MoV 15
Utility knife; X50 Cr MoV 15

Nr kat.	l cm	PLN	EUR
W-1040330720	20	547,54	-



Nóż uniwersalny z ząbkowaym
ostrzem; X50CrMoV15
Utility knife with serrated blade; X50CrMoV15

Nr kat.	l cm	PLN	EUR
W-1040331614	14	389,80	-



Nóż do steków; X50CrMoV15
Steak knife; X50CrMoV15

Nr kat.	l cm	PLN	EUR
W-1040331712	12	387,99	-



Nóż santoku ze szlifem kulowym;
X50CrMoV15
Santoku knife; X50CrMoV15

Nr kat.	l cm	PLN	EUR
W-1040331314	14	463,96	-



Nóż Santoku; X50 Cr MoV 15
Santoku knife; X50 Cr MoV 15

Nr kat.	l cm	PLN	EUR
W-1040331317	17	547,16	-



Nóż nakiri ze szlifem kulowym; X50 Cr MoV 15
Nakiri knife; X50CrMoV15

Nr kat.	l cm	PLN	EUR
W-1040332617	17	574,29	-



Nóż chińskiego szefa kuchni; X50 Cr MoV 15
Chinese chef's knife; X50 Cr MoV 15

Nr kat.	l cm	PLN	EUR
W-1040331818	18	893,55	-



Nóż do filetowania; X50CrMoV15
Filleting knife; X50CrMoV15

Nr kat.	l cm	PLN	EUR
W-1040333818	18	447,68	-



Widelec do mięsa; X50 Cr MoV 15
Meat fork; X50 Cr MoV 15

Nr kat.	l cm	PLN	EUR
W-9040390016	16	539,93	-



Zestaw noży; X50 Cr MoV 15
Knives set; X50 Cr MoV 15

Nr kat.	PLN	EUR
W-1120360205	760,00	-



Zestaw: nóż i widelec; X50 Cr MoV 15
Knife and fork set; X50 Cr MoV 15

Nr kat.	PLN	EUR
W-1120360207	907,11	-





Nóż do oczkowania; X50 Cr MoV 15
Paring knife; X50 Cr MoV 15

Nr kat.	l cm	PLN	EUR
W-1040102207	7	275,84	-



Nóż do warzyw; X50 Cr MoV 15
Vegetable knife; X50 Cr MoV 15

Nr kat.	l cm	PLN	EUR
W-1040100409	9	275,84	-



Nóż do warzyw; X50 Cr MoV 15
Vegetable knife; X50 Cr MoV 15

Nr kat.	l cm	PLN	EUR
W-1040100412	12	275,84	-



Nóż do pomidorów/cytrusów; X50 Cr MoV 15
Tomato / citrus knife; X50 Cr MoV 15

Nr kat.	l cm	PLN	EUR
W-1040101914	14	318,35	-



Nóż do steków; X50CrMoV15
Steak knife; X50CrMoV15

Nr kat.	l cm	PLN	EUR
W-1040101712	12	275,84	-



Nóż do trybowania; X50CrMoV15
Boning knife; X50CrMoV15

Nr kat.	l cm	PLN	EUR
W-1040101414	14	318,35	-



Nóż do trybowania; X50 Cr MoV 15
Boning knife; X50 Cr MoV 15

Nr kat.	l cm	PLN	EUR
W-1040101416	16	372,61	-



Nóż do filetowania; X50 Cr MoV 15
Filleting knife; X50 Cr MoV 15

Nr kat.	l cm	PLN	EUR
W-1040103818	18	377,13	-



Nóż do filetowania; X50 Cr MoV 15
Filleting knife; X50 Cr MoV 15

Nr kat.	l cm	PLN	EUR
W-1040102920	20	369,90	-



Nóż do chleba; X50 Cr MoV 15
Bread knife; X50 Cr MoV 15

Nr kat.	l cm	PLN	EUR
W-1040101123	23	413,31	-



Nóż super slicer; X50CrMoV15
Super slicer knife; X50CrMoV15

Nr kat.	l cm	PLN	EUR
W-1040133126	26	466,67	-



Nóż do łososia; X50 Cr MoV 15
Salmon knife; X50 Cr MoV 15

Nr kat.	l cm	PLN	EUR
W-1040102432	32	566,15	-



Nóż szefa kuchni; X50CrMoV15
Chef's knife; X50CrMoV15

Nr kat.	l cm	PLN	EUR
W-1040130116	16	371,71	-



Nóż szefa kuchni; X50 Cr MoV 15
Chef's knife; X50 Cr MoV 15

Nr kat.	l cm	PLN	EUR
W-1040130120	20	475,71	-



Nóż uniwersalny; X50CrMoV15
Utility knife; X50CrMoV15

Nr kat.	l cm	PLN	EUR
W-1300100718	18	235,14	-



Nóż uniwersalny; X50CrMoV15
Utility knife; X50CrMoV15

Nr kat.	l cm	PLN	EUR
W-1040100720	20	365,38	-



Nóż uniwersalny; X50CrMoV15
Utility knife; X50CrMoV15

Nr kat.	l cm	PLN	EUR
W-1040100723	23	419,64	-



**Nóż uniwersalny ze szlifem kulowym;
X50CrMoV15**
Utility knife; X50CrMoV15

Nr kat.	l cm	PLN	EUR
W-1040100820	20	419,64	-



Nóż uniwersalny; X50CrMoV15
Utility knife; X50CrMoV15

Nr kat.	l cm	PLN	EUR
W-1040100823	23	459,44	-





Nóż santoku ze szlifem kulowym;
X50CrMoV15
Santoku knife; X50CrMoV15

Nr kat.	l cm	PLN	EUR
W-1040131314	14	418,74	-



Nóż Santoku; X50 Cr MoV 15
Santoku knife; X50 Cr MoV 15

Nr kat.	l cm	PLN	EUR
W-1040131317	17	465,77	-



Nóż Santoku; X50 Cr MoV 15
Santoku knife; X50 Cr MoV 15

Nr kat.	l cm	PLN	EUR
W-1040131217	17	419,64	-



Nóż Chai Dao; X50 Cr MoV 15
Chai Dao knife; X50 Cr MoV 15

Nr kat.	l cm	PLN	EUR
W-1040135617	17	473,00	-



Nóż nakiri; X50 Cr MoV 15
Nakiri knife; X50 Cr MoV 15

Nr kat.	l cm	PLN	EUR
W-1040132617	17	441,91	-



Nóż chińskiego szefa kuchni; X50 Cr MoV 15
Chinese chef's knife; X50 Cr MoV 15

Nr kat.	l cm	PLN	EUR
W-1040131818	18	789,00	-



Tasak; X50CrMoV15
Chopper; X50CrMoV15

Nr kat.	l cm	PLN	EUR
W-1040102816	16	829,00	-



Nóż masarski ze szlifem kulowym;
X50CrMoV15
Butcherknife; X50CrMoV15

Nr kat.	l cm	PLN	EUR
W-1040107120	20	481,14	-



Nóż do szynki ze szlifem kulowym;
X50CrMoV15
Ham knife; X50CrMoV15

Nr kat.	l cm	PLN	EUR
W-1040106626	26	465,77	-



Nóż do sera; X50CrMoV15
Cheese knife; X50CrMoV15

Nr kat.	l cm	PLN	EUR
W-1040135214	14	441,35	-



Nóż do sera; X50 Cr MoV 15
Cheese knife; X50 Cr MoV 15

Nr kat.	l cm	PLN	EUR
W-1040132714	14	441,35	-



Zestaw noży; X50 Cr MoV 15
Knifes set; X50 Cr MoV 15

Nr kat.	PLN	EUR
W-1120160206	675,59	-

Noże w zestawie: do oczkowania (9 cm), szefa kuchni (20 cm)
Includes: Paring (9 cm), Cook's (20 cm)



Zestaw noży; X50 Cr MoV 15
Knifes set; X50 Cr MoV 15

Nr kat.	PLN	EUR
W-1120160301	920,68	-

Noże w zestawie: do oczkowania (9 cm), uniwersalny (16 cm), szefa kuchni (20 cm)
Includes: Paring (9 cm), Utility (16 cm), Cook's (20 cm)



Zestaw noży; X50 Cr MoV 15
Knifes set; X50 Cr MoV 15

Nr kat.	PLN	EUR
W-1120160304	958,66	-

Noże w zestawie: do oczkowania (9 cm), do chleba (20 cm), szefa kuchni (20 cm)
Includes: Paring (9 cm), Bread (20 cm), Cook's (20 cm)

KUP ON-LINE



Nóż do oczkowania; X50CrMoV15
Paring knife; X50CrMoV15

Nr kat.	l cm	PLN	EUR
W-1040432207	7	342,77	-



Nóż do warzyw; X50 Cr MoV 15
Vegetable knife; X50 Cr MoV 15

Nr kat.	l cm	PLN	EUR
W-1040430409	9	342,77	-



Nóż do trybowania; X50 Cr MoV 15
Boning knife; X50 Cr MoV 15

Nr kat.	l cm	PLN	EUR
W-1040431414	14	425,07	-



Nóż do chleba podwójnie ząbkowany;
X50 Cr MoV 15
Bread knife double serrated; X50 Cr MoV 15

Nr kat.	l cm	PLN	EUR
W-1040431123	23	566,15	-



Nóż do chleba ząbkowany; X50 Cr MoV 15
Bread knife; X50 Cr MoV 15

Nr kat.	l cm	PLN	EUR
W-1040431023	23	566,15	-





Nóż szefa kuchni; X50 Cr MoV 15
Chef's knife; X50 Cr MoV 15

Nr kat.	l cm	PLN	EUR
W-1040430116	16	455,82	-



Nóż szefa kuchni; X50 Cr MoV 15
Chef's knife; X50 Cr MoV 15

Nr kat.	l cm	PLN	EUR
W-1040430120	20	563,44	-



Nóż szefa kuchni; X50 Cr MoV 15
Chef's knife; X50 Cr MoV 15

Nr kat.	l cm	PLN	EUR
W-1040430123	23	566,15	-



Nóż uniwersalny; X50 Cr MoV 15
Utility knife; X50 Cr MoV 15

Nr kat.	l cm	PLN	EUR
W-1040430716	16	462,85	-



Nóż uniwersalny; X50 Cr MoV 15
Utility knife; X50 Cr MoV 15

Nr kat.	l cm	PLN	EUR
W-1040430720	20	547,54	-



Nóż uniwersalny z ząbkowym
ostrzem; X50CrMoV15
Utility knife with serrated blade; X50CrMoV15

Nr kat.	l cm	PLN	EUR
W-1040431614	14	469,00	-



Nóż do steków; X50 Cr MoV 15
Steak knife; X50CrMoV15

Nr kat.	l cm	PLN	EUR
W-1040431712	12	391,00	-



Nóż Santoku; X50 Cr MoV 15
Santoku knife; X50 Cr MoV 15

Nr kat.	l cm	PLN	EUR
W-1040431317	17	588,00	-



Nóż chińskiego szefa kuchni; X50 Cr MoV 15
Chinese chef's knife; X50 Cr MoV 15

Nr kat.	l cm	PLN	EUR
W-1040431818	18	903,00	-



Widelec do mięsa; X50 Cr MoV 15
Meat fork; X50 Cr MoV 15

Nr kat.	l cm	PLN	EUR
W-9040490016	16	588,00	-

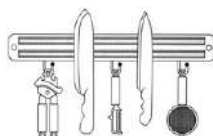

Listwa magnetyczna; tworzywo, stal
Magnetic strip; plastic, steel

Nr kat.	l cm	PLN	EUR
T-7987-045	45	28,41	-
T-7987-060	60	35,82	-

Listwy magnetyczne posiadają dodatkowo haczyki do zawieszania akcesoriów
The magnetic strips are additionally equipped with hooks for hanging accessories

KUP ON-LINE 



Nóż do oczkowania; X50 Cr MoV 15
Paring knife; X50 Cr MoV 15

Nr kat.	l cm	PLN	EUR
W-1025046706	6	85,92	-



Nóż do warzyw; X50CrMoV15
Vegetable knife; X50CrMoV15

Nr kat.	l cm	PLN	EUR
W-1025048208	8	88,62	-



Nóż do warzyw; X50 Cr MoV 15
Vegetable knife; X50 Cr MoV 15

Nr kat.	l cm	PLN	EUR
W-1025045108	8	85,92	-



Nóż do warzyw; X50 Cr MoV 15
Vegetable knife; X50 Cr MoV 15

Nr kat.	l cm	PLN	EUR
W-1025048108	8	85,92	-



Nóż do warzyw; X50 Cr MoV 15
Vegetable knife; X50 Cr MoV 15

Nr kat.	l cm	PLN	EUR
W-1025048110	10	98,00	-



Nóż ząbkowany; X50 Cr MoV 15
Serrated blade knife; X50 Cr MoV 15

Nr kat.	l cm	PLN	EUR
W-1025046314	14	138,00	-



Nóż do pomidorów/cytrusów; X50 Cr MoV 15
Tomato / citrus knife; X50 Cr MoV 15

Nr kat.	l cm	PLN	EUR
W-1025046614	14	138,00	-



Nóż do trybowania; X50CrMoV15
Boning knife; X50CrMoV15

Nr kat.	l cm	PLN	EUR
W-1025046114	14	172,74	-



Nóż do filetowania; X50CrMoV15
Filleting knife; X50CrMoV15; X50CrMoV15

Nr kat.	l cm	PLN	EUR
W-1025049116	16	197,00	-



Nóż do filetowania; X50 Cr MoV 15
Filleting knife; X50 Cr MoV 15

Nr kat.	l cm	PLN	EUR
W-1025047620	20	283,98	-



Nóż do chleba; X50 Cr MoV 15
Bread knife; X50 Cr MoV 15

Nr kat.	l cm	PLN	EUR
W-1025045723	23	280,36	-





Nóż super slicer; X50CrMoV15
Super slicer knife; X50CrMoV15

Nr kat.	l cm	PLN	EUR
W-1025048626	26	296,00	-



Nóż do łososia; X50 Cr MoV 15
Salmon knife; X50 Cr MoV 15

Nr kat.	l cm	PLN	EUR
W-1045047129	29	289,00	-



Nóż szefa kuchni; X50CrMoV15
Chefs knife; X50CrMoV15

Nr kat.	l cm	PLN	EUR
W-1025044816	16	237,00	-



Nóż szefa kuchni; X50 Cr MoV 15
Chefs knife; X50 Cr MoV 15

Nr kat.	l cm	PLN	EUR
W-1025044818	18	285,79	-



Nóż szefa kuchni; X50 Cr MoV 15
Chefs knife; X50 Cr MoV 15

Nr kat.	l cm	PLN	EUR
W-1025044820	20	285,79	-



Nóż szefa kuchni; X50 Cr MoV 15
Chefs knife; X50 Cr MoV 15

Nr kat.	l cm	PLN	EUR
W-1025044823	23	296,00	-



Nóż Santoku; X50 Cr MoV 15
Santoku knife; X50 Cr MoV 15

Nr kat.	l cm	PLN	EUR
W-1025046017	17	315,00	-



Nóż uniwersalny; X50 Cr MoV 15
Utility knife; X50 Cr MoV 15

Nr kat.	l cm	PLN	EUR
W-1025048112	12	118,00	-



Nóż uniwersalny; X50 Cr MoV 15
Utility knife; X50 Cr MoV 15

Nr kat.	l cm	PLN	EUR
W-1025048816	16	209,82	-



Nóż uniwersalny; X50 Cr MoV 15
Utility knife; X50 Cr MoV 15

Nr kat.	l cm	PLN	EUR
W-1025046816	16	198,97	-



Nóż uniwersalny; X50 Cr MoV 15
Utility knife; X50 Cr MoV 15

Nr kat.	l cm	PLN	EUR
W-1025048820	20	217,00	-



Nóż do steków; X50CrMoV15
Steak knife; X50CrMoV15

Nr kat.	l cm	PLN	EUR
W-1025046412	12	118,00	-



Nóż do szynki ze szlifem kulowym;
X50CrMoV15
Ham knife; X50CrMoV15

Nr kat.	l cm	PLN	EUR
W-1025045526	26	349,10	-

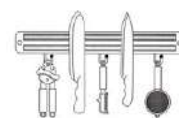

Listwa magnetyczna; tworzywo, stal
Magnetic strip; plastic, steel

Nr kat.	l cm	PLN	EUR
T-7987-045	45	28,41	-
T-7987-060	60	35,82	-

Listwy magnetyczne posiadają dodatkowo haczyki do zawieszania akcesoriów
The magnetic strips are additionally equipped with hooks for hanging accessories





Obieraczka do warzyw
Peeler

Nr kat.	l cm	PLN	EUR
W-3071-7	18	22,61	-



Nóż kolebkowy; X50 Cr MoV 15
Cradle knife; X50 Cr MoV 15

Nr kat.	l cm	PLN	EUR
W-4735-18	18	372,47	-



Nóż do sera; X50 Cr Mo V15
Cheese knife; X50 Cr Mo V15

Nr kat.	l cm	PLN	EUR
W-4812-32	32	627,00	-



Nóż do sera; X50CrMoV15
Cheese knife; X50CrMoV15

Nr kat.	l cm	PLN	EUR
W-1049501012	12	193,54	-



Tasak; X50 Cr MoV 15
Chopper; X50CrMoV15

Nr kat.	l cm	PLN	EUR
W-1129500916	16	370,80	-



Tasak; X50CrMoV15
Chopper; X50CrMoV15

Nr kat.	l cm	PLN	EUR
W-1129500920	20	441,35	-





Stalka; X50 Cr Mo V15
Sharpening steel; X50 Cr Mo V15

Nr kat.	l cm	PLN	EUR
W-3049700323	23/37	105,00	-

gradacja: 180
grit: 180



Stalka; X50 Cr Mo V15
Sharpening steel; X50 Cr Mo V15

Nr kat.	l cm	PLN	EUR
W-3049700526	26/40	138,00	-

gradacja: 180
grit: 180



Stalka diamentowa; X50 Cr Mo V15, pył diamentowy
Sharpening diamond steel; X50 Cr Mo V15, diamond dust

Nr kat.	l cm	PLN	EUR
W-3049705126	26/41	321,97	-

gradacja: 180
grit: 180



Stalka diamentowa; X50 Cr Mo V15, pył diamentowy
Sharpening diamond steel; X50 Cr Mo V15, diamond dust

Nr kat.	l cm	PLN	EUR
W-3049705123	23/37	272,00	-

gradacja: 180
grit: 180



Stalka diamentowa; X50 Cr Mo V15
Sharpening diamond steel; X50 Cr Mo V15, diamond dust

Nr kat.	l cm	PLN	EUR
W-3049705226	26/40	318,35	-

gradacja: 180
grit: 180

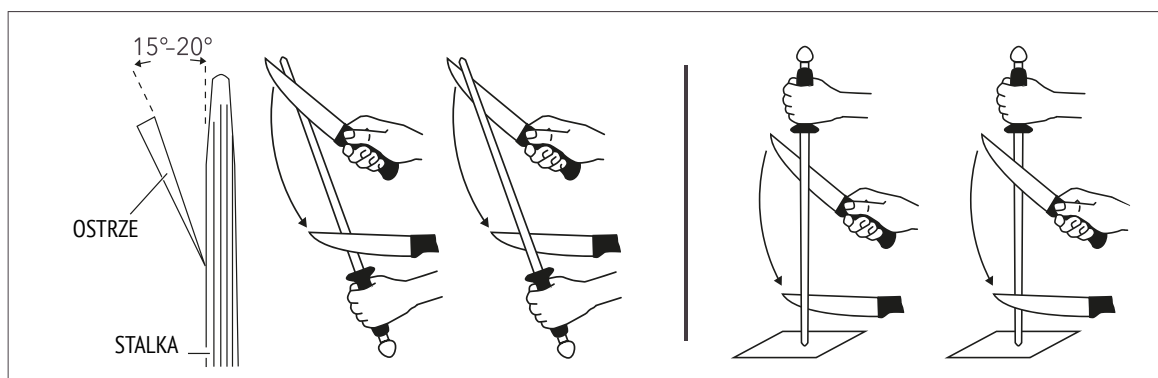

Po dłuższym użytkowaniu, ostrza można łatwo ostrzyć na stawkach WÜSTHOF. Po prostu trzymaj ostrze pod kątem 15-20 stopni i przeciągnij w dół po każdej stronie stalki.

The blades can be easily sharpened on WÜSTHOF sharpening steels after prolonged use. Just hold the blade at a 15-20 degree angle and pull it down on each side of the steel.

Więcej ostrzałek na str. 112-114
See more sharpeners on pages 112-114



etui nie zawiera wyposażenia
knives are not included in this case



Etui magnetyczne na nóż; tworzywo/magnes
Magnetic case; plastic/magnet

Nr kat.	l cm	w cm	PLN	EUR
W-2069640101	16,4	3,9	51,00	-



etui nie zawiera wyposażenia
knives are not included in this case



Etui magnetyczne na nóż; tworzywo/magnes
Magnetic case; plastic/magnet

Nr kat.	l cm	w cm	PLN	EUR
W-2069640102	26,5	4,9	59,69	-



etui nie zawiera wyposażenia
knives are not included in this case



Etui magnetyczne na nóż; tworzywo/magnes
Magnetic case; plastic/magnet

Nr kat.	l cm	w cm	PLN	EUR
W-2069640103	26,8	6,8	78,55	-



etui nie zawiera wyposażenia
knives are not included in this case



Etui magnetyczne na nóż; tworzywo/magnes
Magnetic case; plastic/magnet

Nr kat.	l cm	w cm	PLN	EUR
W-2069640104	20,5	6,8	70,64	-





Torba na noże; ekoskóra
Knife's case; artificial leather

Nr kat.	l cm	w cm	PLN	EUR
W-2189635902	52	13	175,45	-

Mieści 9 noży • Sztuczna skóra • Wymiary rozwiniętej:
dł. 52,5 cm x szer. 48 cm

Holds 9 knives • Artificial leather • Unfolded: L 52,5 cm x W 48 cm

torby nie zawierają wyposażenia
knives are not included in this case



torby nie zawierają wyposażenia
knives are not included in this case



torby nie zawierają wyposażenia
knives are not included in this case



torby nie zawierają wyposażenia
knives are not included in this case



Torba na noże; poliester
Knife's case; polyester

Nr kat.	l cm	w cm	PLN	EUR
W-2189631201	50,5	19	154,00	-

Poliester • Wymiary rozwiniętej: dł. 71 cm x szer. 50,9 cm
Polyester • Unfolded: L 71 cm x W 50,9 cm

Torba na noże; poliester
Knife's case; polyester

Nr kat.	l cm	w cm	PLN	EUR
W-2189631001	50,5	17	194,00	-

Z uchwytem na ramię • Poliester • Wymiary rozwiniętej: dł. 50,5 cm x szer. 68,5 cm
With shoulderstrap • Polyester • Unfolded: L 50,5 cm x W 68,5 cm

Torba na noże; poliester
Knife's case; polyester

Nr kat.	l cm	w cm	PLN	EUR
W-2189631801	51,4	27,6	233,00	-

Z uchwytem na ramię • Poliester • Wymiary rozwiniętej: dł. 51,4 cm x szer. 89,5 cm
With shoulderstrap • Polyester • Unfolded: L 51,4 cm x W 89,5 cm

KUP ON-LINE





Marka Kasumi to 25 pokoleń rodzinnej tradycji wykuwania i obróbki noży ze stali damasceńskiej. Produkcja wysokiej jakości noży kuchennych odbywa się w Japonii, w miejscowości Seki. Noże Kasumi mają fenomenalną ostrość, odporność na korozję, idealne wyważenie oraz wygodną rękojeść.

The Kasumi brand is synonymous of excellence. 25 generations of a family tradition of manufacturing of knives which are forged and processed of Damascus steel. Kasumi specializes in the production of high-quality kitchen knives produced in Seki in Japan. Kasumi knives have incredible sharpness, corrosion resistance, perfect balance and a comfortable handle.

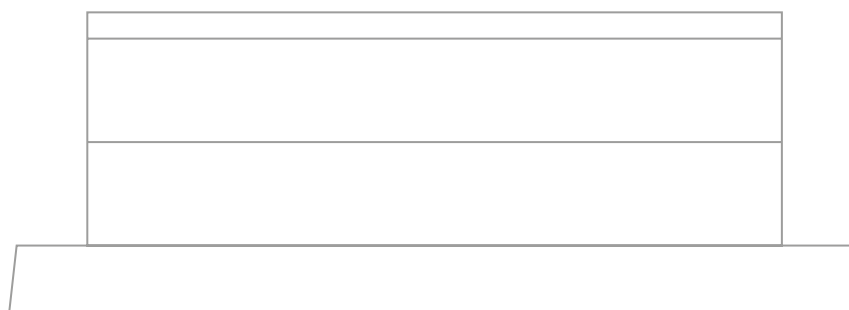
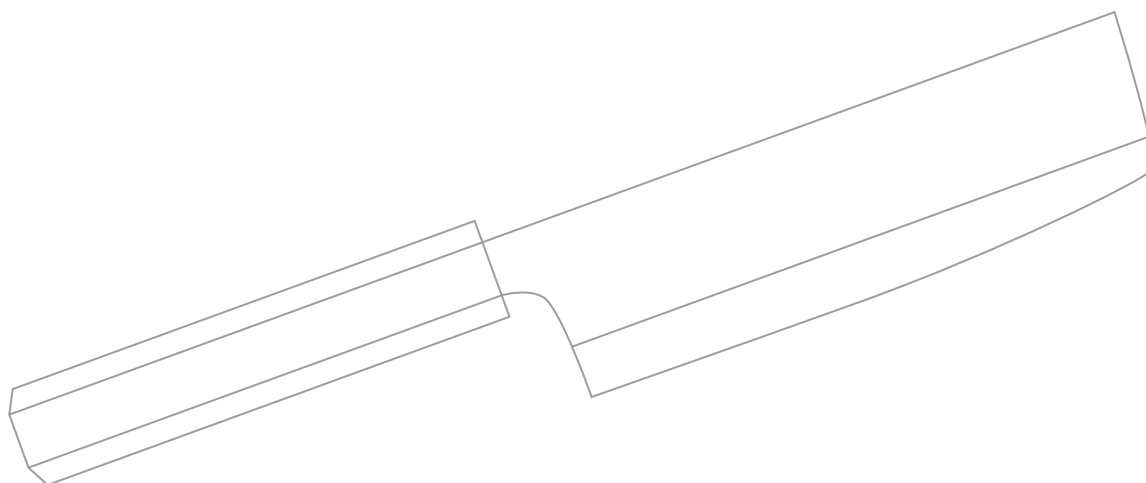

KUP ON-LINE



KASUMI®

KASUMI® BLACK HAMMER



Rzemieślniczo kute noże **Kasumi Black Hammer**, produkowane w limitowanych ilościach. Wykonane są ze stali Aogami /Blue Paper Steel - tradycyjnej japońskiej stali węglowej, wzbogaconej chromem i wolframem (62 HRC). Noże Black Forged wymagają konserwacji i kontrolowanego użytkowania. Nie posiadają właściwości nierdzewnych. Ośmiokątna rękojeść wykonana jest z drewna wiśni.

Forged by master artisans, Kasumi Black Forged Japanese knives are produced in limited quantities. They are made of Aogami / Blue Paper Steel - a traditional Japanese carbon steel enriched with chrome and tungsten (62 HRC). Black Forged knives require maintenance and controlled use. They are not corrosion resistant. The octagonal handle is made of cherry wood.

KASUMI® DAMASCUS



Fenomenalna ostrość noża. Bardzo wygodna rękojeść wykonana z twardego drewna pakka. Noże posiadają 32 warstwy stali damasceńskiej i są perfekcyjnie wyważone. Twardość rdzenia noży to 59-60 HRC.

Phenomenal sharpness of the knife. A comfortable handle made of hard wood pakka. The knives have 32 layers of Damascus steel and are perfectly balanced. The hardness of the core is 59-60 HRC.

KASUMI® HM



Noże **VG-10 HM** wykonane ze stali wysokowęglowej, są kute na gorąco pod naciskiem 300 ton. Młotkowanie sprawia, że stal jest mocniejsza i nieprzywierająca. Rękojeść z żywicy poliacetalowej. Posiadają twardość 59-60 Rockwell.

*Knives **VG-10 HM** made of high carbon steel with Rockwell hardness 59-60. They are hot forged under the pressure of 300 tons. Hammering makes the steel stronger and non-stick. The handle made of polyacetal resin.*

KASUMI® VG-10 PRO



Noże **VG-10 PRO** wykonane z monolitycznej stali wysokowęglowej. Surowiec zapewnia większą odporność na odkształcenia i pękanie niż w przypadku stali damasceńskiej. Rękojeść z polimerów oraz stal VG-10 PRO zapewnia niezwykłą odporność na wilgoć i korozję.

*Knives **VG-10 PRO** made of monolithic high carbon steel. This ensures a greater resistance to deformation and cracking than in the case of Damascus steel. The polymer handle and VG-10 PRO steel provide extraordinary resistance to moisture and corrosion.*

KASUMI® Titanium



Powłoka tytanowa wzmacnia i chroni ostrze ze stali molibdenowo-wanadowej, jest ona nietoksyczna, nie wywołuje alergii, nie chłonie zapachów. Noże te posiadają wyjątkowo ostre ostrze, które jest odporne na działanie chemiczne i kwasy. Uchwyt z polipropylenu odporny do 90 °C.

Titanium coating strengthens and protects the molybdenum-vanadium steel blade, it is non-toxic, does not cause allergies, does not absorb odours. These knives have an extremely sharp blade that is resistant to chemicals and acids. Polypropylene handle resistant up to 90 °C.

KASUMI® TORA



Noże **KASUMI TORA** posiadają rękojeść z drewna magnolii wykończoną czarną powłoką epoksydową zapewniającą doskonałą pewność chwytu i wyważenie. Polipropylenowa obręcz dodaje solidności połączeniu minimalistycznej rękojeści z tradycyjną głownią. Ostrze ze stali nierdzewnej Daido 1K6 (0,6% węgla) o twardości 58/59 HRC.

KASUMI TORA knives with the black Magnolia wood handle coated in black epoxy provides excellent grip and balance. A polypropylene ring adds solidity to the junction of a minimalist handle and a traditional blade. Daido stainless steel blade 1K6 (0.6% carbon) whose level of hardness is 58/59 HRC.





Nóż szefa kuchni Black Hammer; stal niebieska
Chef's knife Black Hammer; blue steel

Nr kat.	l cm	PLN	EUR
K-KSA-700	21	1 334,30	-



Nóż szefa kuchni Black Hammer; stal niebieska
Chef's knife Black Hammer; blue steel

Nr kat.	l cm	PLN	EUR
K-MSA700	21	1 055,59	-



Nóż Santoku Black Hammer; stal niebieska
Santoku knife Black Hammer; blue steel

Nr kat.	l cm	PLN	EUR
K-KSA-100	16,5	1 160,10	-



Nóż Santoku Black Hammer; stal niebieska
Santoku knife Black Hammer; blue steel

Nr kat.	l cm	PLN	EUR
K-MSA100	16,5	881,41	-



Nóż Nakiri Black Hammer; stal niebieska
Nakiri knife Black Hammer; blue steel

Nr kat.	l cm	PLN	EUR
K-KSA-200	16,5	1 160,10	-



Nóż Nakiri Black Hammer; stal niebieska
Nakiri knife Black Hammer; blue steel

Nr kat.	l cm	PLN	EUR
K-MSA200	16,5	881,41	-



Nóż uniwersalny Black Hammer; stal niebieska
Utility knife Black Hammer; blue steel

Nr kat.	l cm	PLN	EUR
K-KSA-500	15	1 009,14	-



Nóż uniwersalny Black Hammer; stal niebieska
Utility knife Black Hammer; blue steel

Nr kat.	l cm	PLN	EUR
K-MSA500	15	776,89	-





Nóż Sashimi; VG10, stal damasceńska
Sashimi knife; VG10 damascus steel

Nr kat.	l cm	PLN	EUR
K-85024	24	997,54	-

16 warstw stali damasceńskiej • Nóż wykuwany i ostrzony tylko z jednej strony - tylko dla osób praworęcznych

16 layers of damascus steel • Knife forged and sharpened only on one side - only for right-handed



Nóż Sashimi; VG10, stal damasceńska
Sashimi knife; VG10 damascus steel

Nr kat.	l cm	PLN	EUR
K-85021	21	962,70	-

16 warstw stali damasceńskiej • Nóż wykuwany i ostrzony tylko z jednej strony - tylko dla osób praworęcznych

16 layers of damascus steel • Knife forged and sharpened only on one side - only for right-handed



Nóż szefa kuchni; VG10, stal damasceńska
Chef's knife; VG10 damascus steel

Nr kat.	l cm	PLN	EUR
K-88024	24	776,89	-

32 warstwy stali damasceńskiej

32 layers of damascus steel



Nóż szefa kuchni; VG10, stal damasceńska
Chef's knife; VG10 damascus steel

Nr kat.	l cm	PLN	EUR
K-88020	20	707,21	-

32 warstwy stali damasceńskiej

32 layers of damascus steel



Nóż do warzyw; VG10, stal damasceńska
Vegetable knife; VG10 damascus steel

Nr kat.	l cm	PLN	EUR
K-82012	24	358,83	-

32 warstwy stali damasceńskiej

32 layers of damascus steel



Nóż do oczkowania; VG10, stal damasceńska
Peeling knife; VG10 damascus steel

Nr kat.	l cm	PLN	EUR
K-82008	8	323,99	-

32 warstwy stali damasceńskiej

32 layers of damascus steel

KUP ON-LINE 



Nóż Santoku; VG10, stal damasceńska
Santoku knife; VG10 damascus steel

Nr kat.	l cm	PLN	EUR
K-84018	18	579,47	-

32 warstwy stali damasceńskiej
32 layers of damascus steel



Nóż Nakiri; VG10, stal damasceńska
Nakiri knife; VG10 damascus steel

Nr kat.	l cm	PLN	EUR
K-84017	30,5	602,70	-

32 warstwy stali damasceńskiej
32 layers of damascus steel



Nóż do chleba; VG10, stal damasceńska
Bread knife; VG10 damascus steel

Nr kat.	l cm	PLN	EUR
K-86025	39	660,76	-

32 warstwy stali damasceńskiej
32 layers of damascus steel



Nóż kuchenny; VG10, stal damasceńska
Utility knife; VG10 damascus steel

Nr kat.	l cm	PLN	EUR
K-86024	24	591,09	-

32 warstwy stali damasceńskiej
32 layers of damascus steel



Nóż uniwersalny; VG10, stal damasceńska
Utility knife; VG10 damascus steel

Nr kat.	l cm	PLN	EUR
K-84020	34	544,63	-

32 warstwy stali damasceńskiej
32 layers of damascus steel



Nóż do trybowania; VG10, stal damasceńska
Boning knife; VG10 damascus steel

Nr kat.	l cm	PLN	EUR
K-84016	16	416,90	-

32 warstwy stali damasceńskiej
32 layers of damascus steel



Nóż do trybowania; VG10, stal damasceńska
Boning knife; VG10 damascus steel

Nr kat.	l cm	PLN	EUR
K-82014	14	416,90	-

32 warstwy stali damasceńskiej
32 layers of damascus steel



Zestaw noży; stal damasceńska
Knife set; damascus steel

Nr kat.	PLN	EUR
K-892015	1 194,95	-

W skład zestawu wchodzi nóż szefa kuchni 20 cm, nóż uniwersalny 15 cm

Set included chefs knife 20 cm, utility knife 15 cm



Zestaw noży; stal damasceńska
Knife set; damascus steel

Nr kat.	PLN	EUR
K-8920158	1 601,39	-

W skład zestawu wchodzi nóż szefa kuchni 20 cm, nóż uniwersalny 15 cm, nóż do oczkowania 8 cm

Set included chefs knife 20 cm, utility knife 15 cm, paring knife 8 cm



Zestaw noży; stal damasceńska
Knife set; damascus steel

Nr kat.	PLN	EUR
K-8918158	1 659,46	-

W skład zestawu wchodzi nóż Santoku 18 cm, Nóż uniwersalny 15 cm, nóż do oczkowania 8 cm

Set included Santoku knife 18 cm, utility knife 15 cm, paring knife 8 cm





Nóż szefa kuchni; VG10
Chef's knife; VG10

Nr kat.	l cm	PLN	EUR
K-78024	24	869,79	-



Nóż szefa kuchni; VG10
Chef's knife; VG10

Nr kat.	l cm	PLN	EUR
K-78020	20	730,44	-



Nóż Santoku; VG10
Santoku knife; VG10

Nr kat.	l cm	PLN	EUR
K-74018	18	730,44	-



Nóż Nakiri; VG10
Nakiri knife; VG10

Nr kat.	l cm	PLN	EUR
K-74017	17	753,67	-



Nóż Santoku; VG10
Santoku knife; VG10

Nr kat.	l cm	PLN	EUR
K-74013	13	556,25	-



Nóż do chleba; VG10
Bread knife; VG10

Nr kat.	l cm	PLN	EUR
K-76025	25	742,05	-



Nóż uniwersalny; VG10
Utility knife; VG10

Nr kat.	l cm	PLN	EUR
K-74020	20	672,38	-



Nóż do trybowania; VG10
Boning knife; VG10

Nr kat.	l cm	PLN	EUR
K-72014	14	556,25	-



Nóż do warzyw; VG10
Vegetable knife; VG10

Nr kat.	l cm	PLN	EUR
K-72012	12	521,41	-



Nóż do warzyw; VG10
Vegetable knife; VG10

Nr kat.	l cm	PLN	EUR
K-72009	9	498,19	-





Nóż szefa kuchni; VG10
Chef's knife; VG10

Nr kat.	l cm	PLN	EUR
K-58020	20	927,85	-
K-58024	24	1 009,14	-
K-58027	27	1 067,21	-



Nóż Santoku; VG10
Santoku knife; VG10

Nr kat.	l cm	PLN	EUR
K-54018	18	916,25	-
K-52013	13	742,05	-



Nóż Nakiri; VG10
Nakiri knife; VG10

Nr kat.	l cm	PLN	EUR
K-54017	17	962,70	-



Nóż do chleba; VG10
Bread knife; VG10

Nr kat.	l cm	PLN	EUR
K-56025	25	881,41	-



Nóż kuchenny; VG-10
Utility knife; VG-10

Nr kat.	l cm	PLN	EUR
K-56024	24	657,72	-



Nóż uniwersalny; VG10
Utility knife; VG10

Nr kat.	l cm	PLN	EUR
K-54020	20	881,41	-





Nóż do trybowania; VG10
Boning knife; VG10

Nr kat.	l cm	PLN	EUR
K-54015	15	730,44	-



Nóż do trybowania; VG10
Boning knife; VG10

Nr kat.	l cm	PLN	EUR
K-52014	14	753,67	-



Nóż do filetowania; VG-10
Fillet knife; VG-10

Nr kat.	l cm	PLN	EUR
K-56018	18	657,72	-

Elastyczne ostrze
_description EN



Nóż do warzyw; VG10
Vegetable knife; VG10

Nr kat.	l cm	PLN	EUR
K-52012	12	707,21	-



Nóż do warzyw; VG10
Vegetable knife; VG10

Nr kat.	l cm	PLN	EUR
K-52008	8	649,15	-



Nóż do oczkowania; VG10
Peeling knife; VG10

Nr kat.	l cm	PLN	EUR
K-52007	7	649,15	-





Nóż szefa kuchni; stal molibdenowo-wanadowa
Chef's knife; molibdenum-vanadium steel

Nr kat.	l cm	col	PLN	EUR
K-22020	20	grafit	419,22	-
K-22020-B	20	niebieski	419,22	-

Pokrycie tytanowe • Uchwyt z tworzywa
Titanium coating • Polymer composite handle



Nóż szefa kuchni; stal molibdenowo-wanadowa
Chef's knife; molibdenum-vanadium steel

Nr kat.	l cm	col	PLN	EUR
K-22013	13	grafit	289,16	-
K-22013-B	13	niebieski	289,16	-

Pokrycie tytanowe • Uchwyt z tworzywa
Titanium coating • Polymer composite handle



Nóż Santoku; stal molibdenowo-wanadowa
Santoku knife; molibdenum-vanadium steel

Nr kat.	l cm	col	PLN	EUR
K-22018	18	grafit	405,28	-
K-22018-B	18	niebieski	405,28	-

Pokrycie tytanowe • Uchwyt z tworzywa
Titanium coating • Polymer composite handle



Nóż uniwersalny; stal molibdenowo-wanadowa
Utility knife; molibdenum-vanadium steel

Nr kat.	l cm	col	PLN	EUR
K-20020	20	grafit	395,99	-
K-20020-B	20	niebieski	399,48	-

Pokrycie tytanowe • Uchwyt z tworzywa
Titanium coating • Polymer composite handle



Nóż do warzyw; stal molibdenowo-wanadowa
Vegetable knife; molibdenum-vanadium steel

Nr kat.	l cm	col	PLN	EUR
K-22012	12	grafit	278,71	-
K-22012-B	12	niebieski	278,71	-

Pokrycie tytanowe • Uchwyt z tworzywa
Titanium coating • Polymer composite handle



Nóż do warzyw; stal molibdenowo-wanadowa
Vegetable knife; molibdenum-vanadium steel

Nr kat.	l cm	col	PLN	EUR
K-22008	8	grafit	246,19	-
K-22008-B	8	niebieski	246,19	-

Pokrycie tytanowe • Uchwyt z tworzywa
Titanium coating • Polymer composite handle





Nóż Sashimi Tora; stal molibdenowo-wanadowa
Sashimi knife Tora; molibdenum-vanadium steel

Nr kat.	l cm	PLN	EUR
K-36848	24	289,16	-

Ostrzony jednostronnie
One side bevel



Nóż szefa kuchni Tora; stal molibdenowo-wanadowa
Chef's knife Tora; molibdenum-vanadium steel

Nr kat.	l cm	PLN	EUR
K-36851	20	231,09	-



Nóż Santoku Tora; stal molibdenowo-wanadowa
Santoku knife Tora; molibdenum-vanadium steel

Nr kat.	l cm	PLN	EUR
K-36841	16,5	219,48	-



Nóż uniwersalny Tora; stal molibdenowo-wanadowa
Utility knife Tora; molibdenum-vanadium steel

Nr kat.	l cm	PLN	EUR
K-36843	20	219,48	-



Nóż Deba Tora; stal molibdenowo-wanadowa
Deba knife Tora; molibdenum-vanadium steel

Nr kat.	l cm	PLN	EUR
K-36850	16,5	289,16	-



Nóż Nakiri Tora; stal molibdenowo-wanadowa
Nakiri knife Tora; molibdenum-vanadium steel

Nr kat.	l cm	PLN	EUR
K-36847	16,5	219,48	-



Nóż do warzyw Tora; stal molibdenowo-wanadowa
Paring knife; molibdenum-vanadium steel

Nr kat.	l cm	PLN	EUR
K-36844	9	149,81	-



Nożyczki
Scissors

Nr kat.	l cm	PLN	EUR
K-81001	24	190,43	-

 KASUMI®



Kamień do ostrzenia noży, naturalny
Knife sharpening stone, natural

Nr kat.	l cm	h cm	w cm	kg	PLN	EUR
K-80003	21	5	8	1,8	819,18	-

Kształt kamienia jest nieregularny, może różnić się od prezentowanego na zdjęciu

Irregular shape, actual product's appearance may differ from the photo



Kamień do ostrzenia noży; syntetyczny
Knife sharpening stone; syntetic

Nr kat.	ziarnistość	PLN	EUR
K-80001	240/1000	219,48	-
K-80002	3000/8000	382,06	-

Przed ostrzeniem namoczyć kamień (10-15 minut) • Gumowa podkładka ułatwia ostrzenie • Zalecany czas ostrzenia: 10 minut • Zastosowanie kamieni o poszczególnej szorstkości: 240 - restaurowanie zniszczonego, wyszczerbionego noża; 1000 - ostrzenie podstawowe; 3000, 8000 - szlifowanie dla uzyskania ekstremalnie ostrej krawędzi

Before sharpening soak the stone in water (10-15 min) • Rubber pad make the operation stable • Recommended time of sharpening: 10 minut • Roughness 240 - restoring damaged, chipped knife; 1000 - basic sharpening; 3000, 8000 - grinding for extreme sharpness



Pomocnik do ostrzenia noży na kamieniu wodnym; nylon/aluminium
Sharpener guide for waterstone; nylon/aluminium

Nr kat.	l cm	thk mm	PLN	EUR
K-EBM	10	15	80,49	-

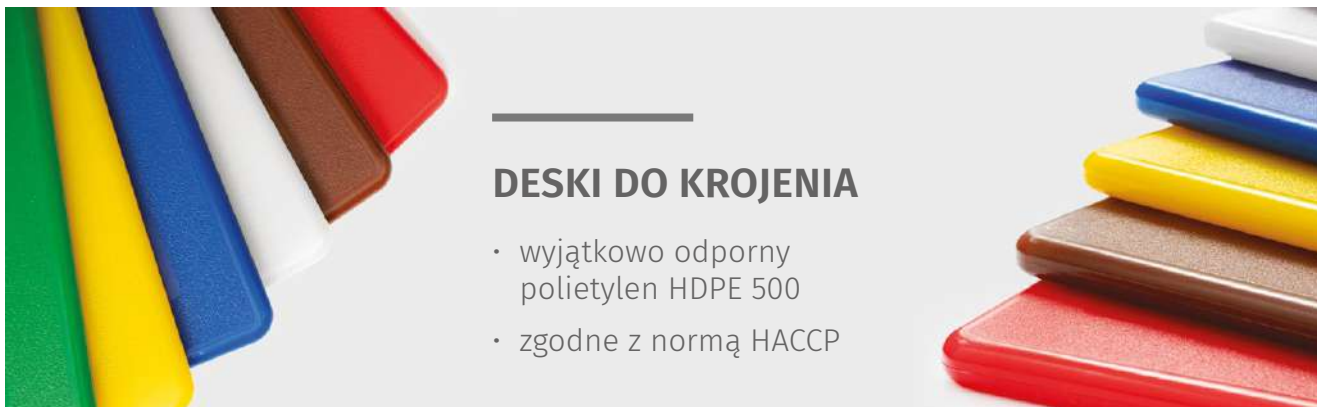

DESKI DO KROJENIA

- wyjątkowo odporny polietylen HDPE 500
- zgodne z normą HACCP



TOMGAST

60 x 40 cm

Deska do krojenia HACCP; PE
Cutting board HACCP; PE

Nr kat.	l cm	w cm	thk mm	col	PLN	EUR
T-4060-BLU	60	40	20	niebieski	148,90	-
T-4060-BRN	60	40	20	brązowy	148,90	-
T-4060-GR	60	40	20	zielony	148,90	-
T-4060-R	60	40	20	czerwony	148,90	-
T-4060-WHT	60	40	20	biały	148,90	-
T-4060-YL	60	40	20	żółty	148,90	-

Polietylen 500 o wysokiej gęstości, nietoksyczny • Odporna na temp. do 90°C
High density polyethylene 500, non-toxic • Resistant up to 90°C



TOMGAST

53 x 32,5 cm

Deska do krojenia HACCP; PE
Cutting board HACCP; PE

Nr kat.	l cm	w cm	thk mm	col	PLN	EUR
T-3253-BLU	53	32,5	15	niebieski	75,37	-
T-3253-BRN	53	32,5	15	brązowy	75,37	-
T-3253-GR	53	32,5	15	zielony	75,37	-
T-3253-R	53	32,5	15	czerwony	75,37	-
T-3253-WHT	53	32,5	15	biały	75,37	-
T-3253-YL	53	32,5	15	żółty	75,37	-

Polietylen 500 o wysokiej gęstości, nietoksyczny • Odporna na temp. do 90°C
High density polyethylene 500, non-toxic • Resistant up to 90°C



TOMGAST

45 x 30 cm

Deska do krojenia HACCP; PE
Cutting board HACCP; PE

Nr kat.	l cm	w cm	thk mm	col	PLN	EUR
T-3045-BLU	45	30	13	niebieski	47,38	-
T-3045-BRN	45	30	13	brązowy	47,38	-
T-3045-GR	45	30	13	zielony	47,38	-
T-3045-R	45	30	13	czerwony	47,38	-
T-3045-WHT	45	30	13	biały	47,38	-
T-3045-YL	45	30	13	żółty	47,38	-

Polietylen 500 o wysokiej gęstości, nietoksyczny • Odporna na temp. do 70°C
High density polyethylene 500, non-toxic • Resistant up to 70°C



Deska do krojenia; buk
Cutting board; beech wood

Nr kat.	l cm	h cm	w cm	PLN	EUR
T-60354	60	4	35	278,60	-



Deska do krojenia; PE
Cutting board; PE

Nr kat.	l cm	w cm	thk mm	PLN	EUR
T-2515W	25	15	10	13,11	-
T-3022W	30	22	10	36,07	-
T-3524W	35	25	20	64,32	-

Polietylen o wysokiej gęstości, nietoksyczny • Odporna na temp. do 70°C • Antypoślizgowe gumowe stopki

High density polyethylene, non-toxic • Resistant up to 70°C • Anti-slip rubber feet

BarEq



Deska barmańska; PE
Cutting board; PE

Nr kat.	l cm	w cm	thk mm	PLN	EUR
T-30202	30	20	20	44,97	-
T-50302	50	30	20	121,13	-

Polietylen nietoksyczny • Odporna na temp. do 60°C • Antypoślizgowe gumowe stopki
Non-toxic polyethylene • Resistant up to 60°C • Anti-slip rubber feet



Stojak na deski; 18/10
Cutting board holder; 18/10

Nr kat.	l cm	h cm	w cm	PLN	EUR
T-1001-015	30	20	18	87,64	-

Druły o śr. 7 mm • Nóżki antypoślizgowe • Pojemność: 6 desek o gr. do 2,5 cm
Robust wire Ø 7 mm • Anti-slip feet • For max 6 cutting boards, max. 2,5 cm thick



Kłoc masarski; PE
Butcher's block; PE

Nr kat.	l cm	h cm	w cm	PLN	EUR
T-KL455	50	5	40	464,00	-

Polietylen 500
Polyethylene 500



Podstawa pod kłoc; 18/10
Base for butcher's block; 18/11

Nr kat.	l cm	h cm	w cm	PLN	EUR
T-KP400	40	75	50	699,00	-

Profil o przekroju kwadratowym • Regulowane stopki
Profiles of square cross-section • The levelling feet



Topór
Axe

Nr kat.	l cm	PLN	EUR
T-230	60	778,00	-

Trzonek wykonany z HDPE, nie kruszy się, nie łamie i nie wypacza podczas wyparzania
Grip made of robust HDPE, resistant to chipping, braking or bending



Piła do kości; 18/10, ABS
Bone saw; 18/10, ABS

Nr kat.	l cm	PLN	EUR
T-2144-450	62	320,63	-
T-2144-901	<i>brzeczot</i>	43,92	-



Prasa do burgerów; Al
Burger press; Al.

Nr kat.	Ø cm	h cm	PLN	EUR
T-1311	11,5	8	47,98	-

Wnętrze pokryte powłoką zapobiegającą przywieraniu
Non-stick coating



Tłuczek do mięsa; 18/10, aluminium
Pastle for meet; 18/10, aluminium

Nr kat.	l cm	g	PLN	EUR
T-WNMT-L	27	1 000	105,60	-



Tłuczek do mięsa; Al
Pastle for meet; Al.

Nr kat.	l cm	g	PLN	EUR
T-1092-255	26	400	36,56	-



Siekacz do mięsa Victor; 18/10, plastic
Chopper for meet Victor; 18/10, plastic

Nr kat.	l cm	h cm	w cm	PLN	EUR
T-45-001	14,5	10,3	4,5	88,00	-

45 ostrzy w 2 rzędach • Włókna mięsa zostają nacięte, a nie zmiądzone • Możliwość zdjęcia stopki w celu czyszczenia • Należy zachować ostrożność przy myciu - bardzo ostre ostrza
45 blades in 2 rows • Meet fibers are cut not crushed • Removable for easy cleaning • Warning: you should be carefull with sharp blades while cleaning



Nożyce do drobiu; 18/10
Poultry scissors; 18/10

Nr kat.	l cm	PLN	EUR
T-9708	25	61,28	-



Nożyce do drobiu i homarów; 18/10
Poultry, lobster scissors; 18/10

Nr kat.	l cm	PLN	EUR
T-2718	18,5	118,04	-





Ostrzałka elektryczna
Electric sharpener

Nr kat.	W	PLN	EUR
CC-2100	175	2 520,00	-
CC-2111	moduł wymienny	840,00	-

- I stopień - diamentowe dyski; II stopień - ultra drobne ścierno-wygładzające diamentowe dyski; III stopień - dyski wygładzające
- możliwe stworzenie dwu i trzy stopniowego kąta ostrzenia do cięcia różnych produktów spożywczych.
- Edge Select™ wybór rodzaju zaostrenia krawędzi noża w zależności od krojonego produktu
- demontowalny moduł ostrzący do mycia również w zmywarce.
- do profesjonalnego użytku - ostrzenie zajmuje mniej niż minutę!
- moc 175 W
- 1st stage - diamond disks; 2nd stage - ultra fine abrasive and smoothing diamond disks; 3rd stage - smoothing discs
- possible to create two and three degree sharpening angles for cutting various food products.
- Edge Select™ select the type of knife edge sharpening depending on the product to be cut
- removable sharpening unit, also dishwasher-safe.
- for professional use - sharpening takes less than a minute!
- motor power 175 W

właściwości: 20°

do noży:



Ostrzałka elektryczna
Electric sharpener

Nr kat.	W	PLN	EUR
CC-2000	115	1 800,00	-
CC-2222	moduł wymienny	600,00	-

- I stopień dyski pokryte diamentem, II stopień ultra drobne ścierno-wygładzające
- Technologia Dizor - dwustopniowa krawędź ostrza
- demontowalny moduł ostrzący do mycia również w zmywarce.
- do profesjonalnego użytku - ostrzenie zajmuje mniej niż minutę!
- moc 115 W
- 1st stage - diamond coated discs, 2nd stage ultra-fine abrasive-smoothing
- Dizor technology - two-stage blade edge
- removable sharpening unit, also dishwasher safe.
- for professional use - sharpening takes less than a minute!
- motor power 115 W

właściwości: 20°

do noży:



Ostrzałka elektryczna
Electric sharpener



Nr kat.	W	PLN	EUR
CC-1520	75	900,00	-

- profesjonalna ostrzałka do ostrzenia noży azjatyckich i europejskich.
- I stopień - diamentowe dyski do noży japońskich; II - diamentowe dyski do noży europejskich; III - dyski wygładzające także do noży azjatyckich i falistych
- Technologia Dizor dla noży europejskich
- Technologia Trizor dla noży japońskich
- moc 75 W
- professional sharpener for sharpening Asian and European knives.
- 1st stage - diamond discs for Japanese knives; 2nd - diamond discs for European knives; 3rd stage - smoothing discs also for Asian and wavy knives
- Dizor technology for European knives
- Trizor technology for Japanese knives
- motor power 75 W

właściwości: 15° 20°

do noży:



Ostrzałka elektryczna
Electric sharpener



Nr kat.	W	PLN	EUR
CC-130	125	900,00	-

- I stopień - diamentowe dyski; II stopień - minitalka z możliwością przekręcania i ostrzenia w nowym miejscu (28 stopni, każdy wystarcza na kilka tysięcy użyci), III stopień - dyski wygładzające
- łatwa w obsłudze
- możliwe stworzenie dwu i trzy stopniowego kąta ostrzenia do cięcia różnych produktów spożywczych,
- moc 125 W
- 1st stage - diamond discs, 2nd stage - mini-table with the possibility of turning and sharpening in a new place (28 degrees, each is enough for several thousand uses), 3rd stage - smoothing discs
- easy to use
- possible to create two and three degree sharpening angle for cutting various food products.
- motor power 125 W

właściwości: 20°

do noży:



Ostrzałka elektryczna
Electric sharpener



Nr kat.	W	PLN	EUR
CC-120	75	852,00	-

- I stopień - drobno-ścierno diamentowe dyski; II stopień - ultra drobne ścierno-wygładzające diamentowe dyski; III stopień - dyski wygładzające
- możliwe stworzenie dwu i trzy stopniowego kąta ostrzenia do cięcia różnych produktów spożywczych,
- moc: 75 W
- 3-stage: 1st stage - fine-abrasive diamond discs; 2nd stage - ultra fine abrasive - smoothing diamond discs; 3rd stage - smoothing discs
- possible to create two and three degree sharpening angles for cutting various food products.
- motor power: 75 W

właściwości: 20°

do noży:



Ostrzałka elektryczna
Electric sharpener

Nr kat.	W	PLN	EUR
CC-320	77	624,00	-

- I stopień - diamentowe dyski; II stopień - dyski Ultra Strop® - elastyczne, wygładzające dyski do ostrości brzytwy,
- efekt ostrzenia: dwustopniowa krawędź ostrza
- moc: 77W

- 3-stage: 1st stage - fine-abrasive diamond discs; 2nd stage - ultra fine abrasive - smoothing diamond discs; 3rd stage - smoothing discs

- possible to create two and three degree sharpening angles for cutting various food products.

- motor power: 75 W

właściwości: 20°



do noży:

OSTRZAŁKI ELEKTRYCZNE

właściwości:

-  — dwustopniowa krawędź
-  — trzystopniowa krawędź
-  — kąt ostrzenia 15°
-  — kąt ostrzenia 20°
-  — kąt ostrzenia 15°/20°
-  — ostrze jednostronne
-  — mikroząbkowanie ostrza
-  — efekt ostrzenia na stalce

do noży:

-  — noże europejskie
-  — noże japońskie
-  — noże do chleba (ząbkowane)

ChefsChoice	Elektryczne ostrzałki do noży								
Model	CC-2100	CC-2000	CC-1520	CC-120	CC-320	CC-130	CC-312	CC-316	CC-270
Precyzyjne prowadnice do noży	•	•	•	•	•	•	•	•	•
Stopnie ostrzenia	3	2	3	3	2	3	2	2	3
Kąt ostrzenia noża	20°	20°	15° lub 20°	20°	20°	20°	20°	15°	20°
Diamentowy materiał ścierny	•	•	•	•	•	•	•	•	•
Elastyczne dyski polerujące	•		•	•	•	•			
Stopień wstępnego ostrzenia Heavy Duty	•			•			•		•
Do noży azjatyckich			•					•	
Do noży falistych	•	•	•	•	•	•		•	•
Stalka						•			
Moc (W)	175	150	125	125	125	125	120	120	42
Zalecany do regeneracji mocno zużytych noży	•		•	•		•			

Sposób działania ostrzałki:



OSTRZAŁKI ELEKTRYCZNE I HYBRYDOWE



Ostrzałka elektryczna
Electric sharpener

Nr kat.	W	PLN	EUR
CC-312	120	540,00	-

- 2-stopniowa: **I stopień** - diamentowe dyski; **II stopień** - dyski ostrzące
- Technologia Dizer® - dwustopniowa krawędź ostrza
- moc 120 W
- 2-stage: **1st stage** - diamond discs; **2nd stage** - sharpening discs
- Dizer® technology - two-stage blade edge
- motor power 120 W

właściwości:   

do noży:  



Ostrzałka elektryczna
Electric sharpener

Nr kat.	W	PLN	EUR
CC-316	120	576,00	-

- 2-stopniowa: **I stopień** - drobno-ścierny diamentowe dyski; **II stopień** - Ultra Strop® - elastyczne, wygładzające dyski do ostrości brzozy
- Technologia Dizer® - dwustopniowa krawędź ostrza
- obudowa wykonana z tworzywa sztucznego w kolorze czarny
- moc 120 W
- 2-stage: **1st stage** - fine-abrasive diamond discs; **2nd stage** - Ultra Strop® - flexible, smoothing discs to razor sharpness
- Dizer® technology - two-stage blade edge
- black plastic housing
- motor power 120 W

właściwości:   

do noży: 



Ostrzałka hybrydowa
Hybrid sharpener

Nr kat.	W	PLN	EUR
CC-270	40	420,00	-

- stopień I i II - napęd elektryczny, stopień III do ostrzenia ręcznego
- 3-stopniowa: **I stopień** - diamentowe dyski; **II stopień** - ultra-drobne diamentowe dyski; **III stopień** - dyski wygładzające
- efekt ostrzenia: trzystopniowa krawędź ostrza
- moc 40 W
- stage I and II - electric drive, stage III for manual sharpening
- 3-stage: **1st stage** - diamond discs; **2nd stage** - ultra-fine diamond discs; **3rd stage** - smoothing discs
- sharpening effect: three-stage blade edge
- motor power 40 W

właściwości:   

do noży:  

KUP ON-LINE 



Ostrzałka manualna
Sharpener

Nr kat.	PLN	EUR
CC-464	192,00	-

- 2-stopniowa: I stopień - diamentowe dyski; II stopień - ultra-drobne diamentowe dyski
- ultradrobne diamentowe dyski (faza 2) tworzą mikroskopijne ząbki na ostrzu, co ułatwia krojenie włóknistych produktów, takich jak mięso, niektóre ryby i warzywa włókniste
- Lekka i kompaktowa

- 2-stage: 1st stage - diamond discs; 2nd stage - ultra-fine diamond discs
- ultra-fine diamond discs (stage 2) create microscopic cloves on the blade, making it easier to cut fibrous products such as meat, some fish and fibrous vegetables
- Light and compact

właściwości:  20° 

do noży:  



Ostrzałka manualna
Sharpener

Nr kat.	PLN	EUR
CC-463	192,00	-

- dedykowana do ostrzy azjatyckich (15 stopni)
- 2-stopniowa: faza I - diamentowe dyski; faza II - dyski wygładzające
- ultradrobne diamentowe dyski (faza 2) tworzą mikroskopijne ząbki na ostrzu, co ułatwia krojenie włóknistych produktów, takich jak mięso, niektóre ryby i warzywa włókniste
- Lekka i kompaktowa

- 2-stage: 1st stage - diamond discs; 2nd stage - ultra-fine diamond discs
- ultra-fine diamond discs (stage 2) create microscopic cloves on the blade, making it easier to cut fibrous products such as meat, some fish and fibrous vegetables
- Light and compact

właściwości:  15°

do noży:  



Ostrzałka manualna
Sharpener

Nr kat.	PLN	EUR
CC-4633	156,00	-

- 3-stopniowa: I - do noży azjatyckich; II - do noży europejskich; III - dyski wygładzające
- Dzięki dwóm stopniom powstaje maksymalnie ostre i mocne ostrze w kształcie gotyckiego V
- III stopień tworzy mikroskopijne ząbki, co ułatwia krojenie włóknistych produktów, jak mięso
- Wygodny, ergonomiczny uchwyt
- Niewielki rozmiar

- 3-stage: I - for Asian style knives; II - for european knives; III - polishing discs
- Separate sharpening and honing stages for razor sharp edge
- Creates double-bevel edges that last longer
- Creates steeled edge in stage III, which ensures easier cutting of meat
- Ergonomic handle
- Convenient compact size

właściwości:  15°
20°

do noży:  



Ostrzałka kieszonkowa
Pocket sharpener

Nr kat.	PLN	EUR
CC-476	48,00	-

- 2-stopniowa, okładziny: I - ostrzące; II wygładzające
- Do ostrzy: gładkich
- Rękojeść z tworzywa „soft touch”

- 2-stopniowa, okładziny: I - ostrzące; II wygładzające
- Do ostrzy: gładkich
- Rękojeść z tworzywa „soft touch”

właściwości:  20°

do noży: 



Diametowa stalka
Diamond hone

Nr kat.	l cm	PLN	EUR
CC-416-10	26 / 39	156,00	-

- Owalny kształt
- Powierzchnia robocza pokryta powłoką diamentową
- Lekka
- Rękojeść z tworzywa antypoślizgowego
- Zarówno dla prawy, jak i leworęcznych

- Oval-shaped
- Coated with 100% ultra-fine diamond abrasives
- Simultaneously steels, hones and realigns the knife edge
- Light and perfectly balanced
- Easy grip, non-slip textured handle



KOSZE NA ŚMIECI



Kosz na śmieci 100 l z pokrywą; PP
Refuse bin with lid 100 L; PP

Nr kat.		Ø cm	h cm	cap l	col	PLN	EUR
DE-23110-SET	<i>kosz</i>	51,5	67	100	biały	217,00	-
DE-23108	<i>podstawa na kółkach</i>	39				478,68	-



Kosz na śmieci 110 l; PP
Refuse bin 110L; PP

Nr kat.	l cm	h cm	w cm	cap l	PLN	EUR
DE-23250-SET	57	88	42	110	220,75	-

Pokrywy sprzedawane osobno
Lids sold separately



Pokrywa z otworem do kosza DE-23250; PP
Lid with gap for refuse bin DE-23250; PP

Nr kat.	col	PLN	EUR
DE-23250-B	niebieski	53,44	-
DE-23250-C	czarny	53,44	-
DE-23250-G	zielony	53,44	-
DE-23250-R	czerwony	53,44	-
DE-23250-Y	żółty	53,44	-



Pokrywa pełna do kosza na śmieci 23250-SET; PP
Lid for 23250-SET refuse bin; PP

Nr kat.	col	PLN	EUR
DE-23450-B	niebieski	47,50	-
DE-23450-C	czarny	47,50	-
DE-23450-G	zielony	47,50	-
DE-23450-R	czerwony	47,50	-
DE-23450-Y	żółty	47,50	-



Kosz na śmieci 120 l z pedałem; PP
Refuse bin with pedal 120 L; PP

Nr kat.	l cm	h cm	w cm	cap l	PLN	EUR
DE-23400-SET	51	87,5	42,5	120	308,25	-

Pokrywy sprzedawane osobno
Lids sold separately



Pokrywa do kosza DE-23400; PP
Lid for refuse bin DE-23400; PP

Nr kat.	col	PLN	EUR
DE-23400-B	niebieski	56,64	-
DE-23400-C	czarny	56,64	-
DE-23400-G	zielony	56,64	-
DE-23400-R	czerwony	56,64	-
DE-23400-Y	żółty	56,64	-



Worek na odpady z taśmą - 10 szt.
Drawstring waste bag - 10 pcs

Nr kat.	cap l	PLN	EUR
T-23000	140	11,30	-

Pasuje do wszystkich koszy z oferty • 1 rolka - 10 sztuk
Fits all baskets on offer • 1 roll - 10 bags

KUP ON-LINE



echtermann®
for professionals



130 LAT DOŚWIADCZENIA I INNOWACJI

Sukces Echtermann® nie jest dziełem przypadku. Pasja do produktów wysokiej jakości ma długą tradycję. Obecnie firma jest wiodącym na świecie producentem armatury do profesjonalnych kuchni i gastronomii. „Made in Germany” to znak doskonałej jakości tej marki. Każdy produkt jest kilkakrotnie sprawdzany przez wyspecjalizowanych pracowników i systemy kontroli jakości. Doskonałe pod względem jakości i funkcjonalności Główną cechą produktów Echtermann jest ich długa żywotność, oraz system oszczędzania wody, dzięki którym są one przyjazne środowisku i sprzyjają oszczędnościom inwestorów.

130 YEARS OF EXPERIENCE AND INNOVATION

Echtermann®'s success did not happen by chance. The passion for high-quality products has a long tradition. Currently, the company is the world's leading manufacturer of fittings for professional kitchens and gastronomy. "Made in Germany" is a sign of the excellent quality of this brand. Each product is checked several times by specialized employees and quality control systems. Perfect for quality and functionality.... The main feature of Echtermann products is their long service life and a water-saving system, thanks to which they are environmentally friendly and contribute to savings for investors.



Leadership in Energy and Environmental Design (LEED) LEED to system klasyfikujący do sektora budownictwa ekologicznego, rozwinięty w 1998 roku przez U.S. Green Building Council. System ten definiuje standardy uwzględniające zrównoważony rozwój, recykling oraz długofalowość rozwiązań. System LEED w Echtermann® oznacza specjalną konstrukcję prysznicza ograniczającą przepływ wody do maks. 6l/min bez pogorszenia właściwości spłukiwania, co wpływa na oszczędność wody oraz ograniczenie kosztów eksploatacji. Zużycie wody jest ponad dwukrotnie mniejsze, niż w standardowym rozwiązaniu, z zachowaniem pełnego komfortu pracy.

Leadership in Energy and Environmental Design (LEED) LEED is a classification system for the green building sector, developed in 1998 by the U.S. Green Building Council. This system defines standards that take into account sustainable development, recycling and long-term solutions. The LEED system in Echtermann® means a special shower design that limits the water flow to a maximum of 6 l / min without compromising flushing properties, which saves water and reduces operating costs. Water consumption is more than twice lower than in the standard solution, while maintaining full comfort of work.



Woda jest drogocennym zasobem naturalnym, z którym musimy korzystać rozsądnie. Firma Echtermann jako świadomy producent wysokiej jakości armatury, z zastosowaniem najnowszych rozwiązań technologicznych proponuje linię produktów ekologicznych o długiej żywotności. **Blueline- ogranicz zużycie wody o nawet 50%.**

*Water is a precious natural resource that we must use wisely. The company Echtermann as a conscious manufacturer of high-quality fittings, using the latest technological solutions offers a line of ecological products with a long service life. **Blueline- reduce water consumption by up to 50%.***

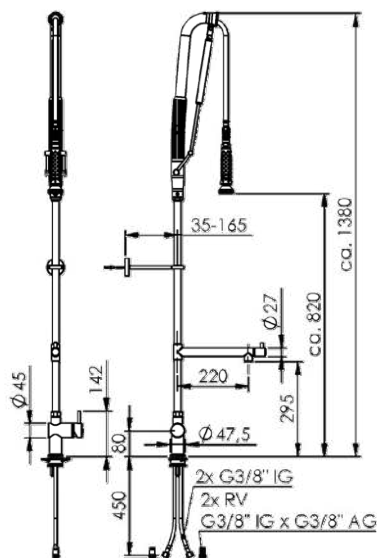
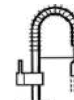

Bateria prysznicowa; Stal nierdzewna 316 L
Pre-rinse unit; 316 L Stainless steel

Nr kat.	op.	PLN	EUR
EC-301-102-000	1	4 510,32	-

- Wersja tylko do wysokiego ciśnienia, ciśnienie robocze 1-6 bar
- Uchwyt termoizolacyjny
- Sprężyna gazowa
- Automatyczny zawór, woda płynie tylko wtedy, gdy pistolet natryskowy jest pociągnięty w dół
- Obustronnie odchylane mocowanie jednostki natryskowej
- Pistolet natryskowy z głowicą natryskową ze stali szlachetnej, sitko z tworzywa sztucznego
- Obrotowa wylewka Premium na wyciąganej głowicy, występ P = 250 mm / wysokość H = 295 mm
- Zwiększona swobodna powierzchnia pracy: Natrysk ręczny z przegubem kulowym, obustronna obrotowa głowica prysznicowa (360°)
- Regulacja temperatury i przepływu z nowoczesnym wkładem ceramicznym eco (2-stopniowa funkcja oszczędzania wody)
- Elastyczne węże przyłączeniowe 2 x 500 mm, nakrętka złączkowa 3/8"
- Łatwy w montażu system mocowań
- Zawory zwrotne zapobiegają cyrkulacji między ciepłą i zimną wodą oraz zasysaniu brudnej wody
- Montaż ścienny bez widocznego gwintu (możliwość skrócenia 135 do 165 mm)
- Materiał stal nierdzewna
- Odporność na temperaturę do 80°C
- Otwór w blacie roboczym $\phi 30$ mm
- Wszystkie spawy są wolne od kadmu i ołowiu
- Uszczelki aluminiowe odpowiadają przepisom KTW

- Version for high pressure only, operating pressure 1-6 bar
- Heat insulating handle
- Gas pressure spring
- With automatic pull, water only flows when the spray gun is pulled down
- Spray unit attachment can be pivoted to both sides
- Spray gun with stainless steel spray head, plastic strainer
- Automated pull mechanism: The valve opens when the hand shower is pulled down and closes when it is moved up, supported by gas pressure spring = self-closing
- Premium swivel spout lockable at the outlet head, projection P = 250 mm / height H = 295 mm
- Temperature and flow control with modern eco ceramic cartridge (2 stage water saving function)
- Flexible connection hoses 2 x 500 mm, union nut 3/8"
- Easy-to-install fastening system
- Non-return valves prevents circulation between hot and cold water and suctioning of dirty water
- Wall mount without visible thread (can be shortened 35 to 165mm)
- Material stainless steel
- Hot water resistant up to 80°C
- Worktop bore hole $\phi 30$ mm
- All solders are free of cadmium and lead

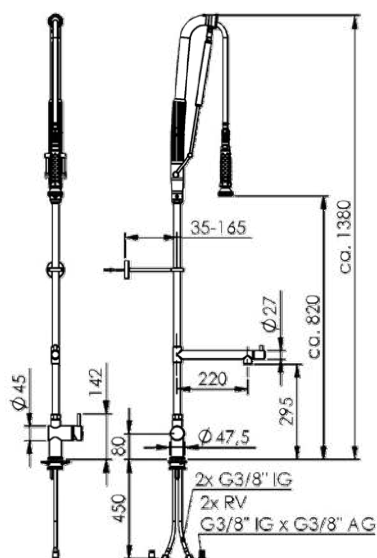

Bateria prysznicowa; Stal nierdzewna 316 L
Pre-rinse unit; 316 L Stainless steel

Nr kat.	op.	PLN	EUR
EC-301-102-220-295	1	5 051,74	-

- Wersja tylko do wysokiego ciśnienia, ciśnienie robocze 1-6 bar
- Uchwyt termoizolacyjny
- Sprężyna gazowa
- Z automatycznym pociągnięciem, woda płynie tylko wtedy, gdy pistolet natryskowy jest pociągnięty w dół
- Obustronnie odchylane mocowanie jednostki natryskowej
- Pistolet natryskowy z głowicą natryskową ze stali szlachetnej, sitko z tworzywa sztucznego
- Obrotowa wylewka Premium zamykana na wyciąganej głowicy, występ P = 250 mm / wysokość H = 295 mm
- Zwiększona swobodna powierzchnia pracy: Natrysk ręczny z przegubem kulowym, obustronna obrotowa głowica prysznicowa (360°)
- Regulacja temperatury i przepływu z nowoczesnym wkładem ceramicznym eco (2-stopniowa funkcja oszczędzania wody)
- Elastyczne węże przyłączeniowe 2 x 500 mm, nakrętka złączkowa 3/8"
- Łatwy w montażu system mocowań
- Zawory zwrotne zapobiegają cyrkulacji między ciepłą i zimną wodą oraz zasysaniu brudnej wody
- Montaż ścienny bez widocznego gwintu (możliwość skrócenia 35 do 165 mm)
- Materiał stal nierdzewna
- Odporność na temperaturę do 80°C
- Otwór w blacie roboczym $\phi 30$ mm
- Wszystkie spawy są wolne od kadmu i ołowiu
- Uszczelki aluminiowe odpowiadają przepisom KTW

- Version for high pressure only, operating pressure 1-6 bar
- Heat insulating handle
- Gas pressure spring
- With automatic pull, water only flows when the spray gun is pulled down
- Spray unit attachment can be pivoted to both sides
- Spray gun with stainless steel spray head, plastic strainer
- Automated pull mechanism: The valve opens when the hand shower is pulled down and closes when it is moved up, supported by gas pressure spring = self-closing
- Premium swivel spout lockable at the outlet head, projection P = 250 mm / height H = 295 mm
- Temperature and flow control with modern eco ceramic cartridge (2 stage water saving function)
- Flexible connection hoses 2 x 500 mm, union nut 3/8"
- Easy-to-install fastening system
- Non-return valves prevents circulation between hot and cold water and suctioning of dirty water
- Wall mount without visible thread (can be shortened 35 to 165mm)
- Material stainless steel
- Hot water resistant up to 80°C
- Worktop bore hole $\phi 30$ mm
- All solders are free of cadmium and lead
- All seals comply with the KTW regulations



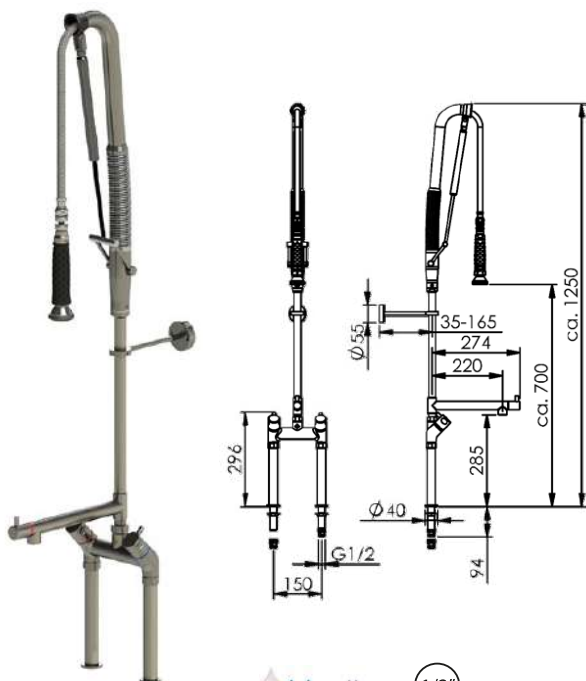

Bateria prysznicowa; Stal nierdzewna 316 L
Pre-rinse unit; 316 L Stainless steel

Nr kat.	op.	PLN	EUR
EC-305-201-220-285	1	5 257,50	-

- Bateria mieszakowa: Dwukurkowa
- Wielkość nominalna 1/2"
- Automatyczny zawór, woda płynie tylko wtedy, gdy pistolet natryskowy jest pociągnięty w dół
- Tylko dla wysokiego ciśnienia, ciśnienie robocze 1 - 6 bar (14,5 - 87 psi).
- Głowica ceramiczna w mieszaczu i wylewce
- Kurki izolowane termicznie
- Pistolet natryskowy z miękkim uchwytem, głowica ze stali nierdzewnej, sitko z tworzywa sztucznego
- Wylewka obrotowa Premium (360°) z zaworem czołowym dla komfortowej obsługi, wysięg A = 150mm / 220mm / 270mm, wysokość H = 285 mm
- Sprężyna gazowa
- Uchwyt ścienny, bez widocznego gwintu (35 mm do 165 mm)
- Pleciony wąż o wysokiej wydajności, nierdzewny, z przezroczystą osłoną z tworzywa sztucznego, 800mm
- Zawory zwrotne zapobiegają cyrkulacji między ciepłą i zimną wodą oraz cofaniu się brudnej wody
- Podłączenie/Instalacja: Otwór w blacie roboczym 2 x Ø22mm
- Wydajność strumienia ręcznego 9 - 15 l/min (2 - 4 bar, 29 - 58 psi)
- Wydajność wylewki obrotowej 19 - 27 l/min (2 - 4 bar, 29 - 58 psi)
- Odporność na temperaturę do 80°C
- Zwiększona i swobodna powierzchnia pracy: Natrysk ręczny z przegubem kulowym, obustronna obrotowa głowica prysznicowa (360°)
- Oszczędność wody: System samozamykający
- Trwałość i niskie koszty utrzymania: Mechanizm otwierania powyżej rury wznoszącej, wąż i natrysk ręczny nigdy nie znajdują się pod ciśnieniem wody
- Bezpieczeństwo pracy: Kontrolowane zamykanie w przypadku wyślizgnięcia się pistoletu z ręki
- Skoncentrowany strumień wody zapewniający idealny efekt płukania wstępnego

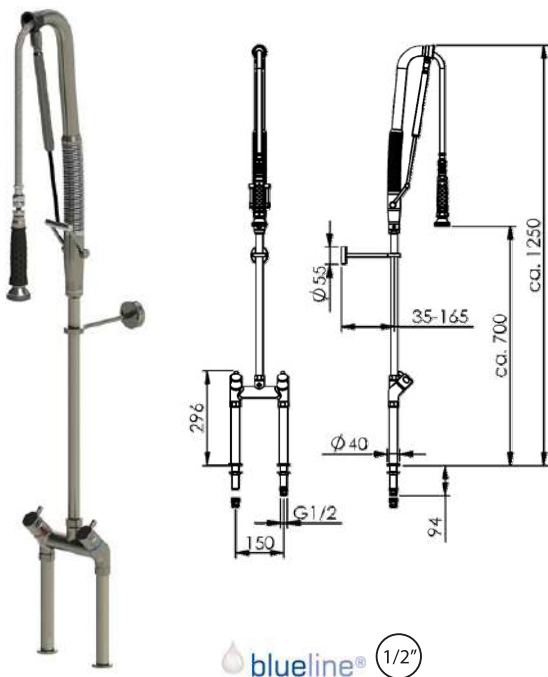
- Mixer tap: Two-handle mixer tap
- Nominal size 1/2"
- With automatic pull, water only flows when the spray gun is pulled down
- For high pressure only, operating pressure 1 - 6 bar (14.5 - 87 psi)
- For high pressure only
- Ceramic headworks - mixer, spout
- Heat insulating handles
- Anti-slip, soft grip hand shower with stainless steel shower head, plastic strainer
- Premium swivel spout (360°) with front valve for comfortable operation, Projection A = 150mm / 220mm / 270mm, Height H = 285 mm
- Gas pressure spring
- Wall bracket, no visible thread (35mm to 165mm)
- Hose: Braided high-performance hose, stainless, with transparent plastic cover, 800mm
- Non-return valves prevent the circulation between hot and cold water as well as the backflow of dirty water
- Connection/Installation: Worktop bore hole 2 x Ø22mm
- Flow rate hand spray 9 - 15 l/min (2 - 4 bar, 29 - 58 psi)
- Flow rate swivel spout 19 - 27 l/min (2 - 4 bar, 29 - 58 psi)
- Hot water resistant up to 80°C
- Extended and free work area: Hand-spray with ball joint, shower attachment swivels to both sides (360°)
- Water saving: Self-closing system
- Durable and low-maintenance: Opening mechanism above rising tube, hose and hand spray are never under water pressure
- Work safety: Controlled closing if spray gun slips off your hand
- Concentrated water jet for ideal pre-rinsing result



Bateria prysznicowa; Stal nierdzewna 316 L
Pre-rinse unit; 316 L Stainless steel

Nr kat.	op.	PLN	EUR
EC-305-201-000	1	4 715,98	-

- Bateria mieszakowa: Dwukurkowa
- Wielkość nominalna 1/2"
- Ciśnienie robocze 1 - 6 bar (14,5 - 87 psi)
- Automatyczny zawór, woda płynie tylko wtedy, gdy pistolet natryskowy jest pociągnięty w dół
- Tylko dla wysokiego ciśnienia
- Głowica ceramiczna (mieszacz)
- Kurki izolowane termicznie
- Pistolet natryskowy z miękkim uchwytem, głowica ze stali nierdzewnej, sitko z tworzywa sztucznego
- Sprężyna gazowa
- Uchwyt ścienny, bez widocznego gwintu (35mm do 165mm)
- Pleciony wąż o wysokiej wydajności, nierdzewny, z przezroczystą osłoną z tworzywa sztucznego, 800mm
- Zawory zwrotne zapobiegają cyrkulacji między ciepłą i zimną wodą oraz cofaniu się brudnej wody
- Podłączenie/Instalacja: Otwór w blacie roboczym 2 x Ø22mm
- Wydajność strumienia ręcznego 9 - 15 l/min (2 - 4 bar, 29 - 58 psi)
- Odporność na temperaturę do 80°C
- Zwiększona i swobodna powierzchnia pracy: Dysza ręczna z przegubem kulowym, głowica prysznicowa obraca się na obie strony (360°)

- Mixer tap: Two-handle mixer tap
- Nominal size 1/2"
- Operating pressure 1 - 6 bar (14.5 - 87 psi)
- With automatic pull, water only flows when the spray gun is pulled down
- For high pressure only
- Ceramic headworks (mixer)
- Heat insulating handles
- Anti-slip, soft grip hand shower with stainless steel shower head, plastic strainer
- Gas pressure spring
- Wall bracket, no visible thread (35mm to 165mm)
- Hose: Braided high-performance hose, stainless, with transparent plastic cover, 800mm
- Non-return valves prevent the circulation between hot and cold water as well as the backflow of dirty water
- Connection/Installation: Worktop bore hole 2 x Ø22mm
- Flow rate hand spray 9 - 15 l/min (2 - 4 bar, 29 - 58 psi)
- Hot water resistant up to 80°C
- Extended and free work area: Hand-spray with ball joint, shower attachment swivels to both sides (360°)

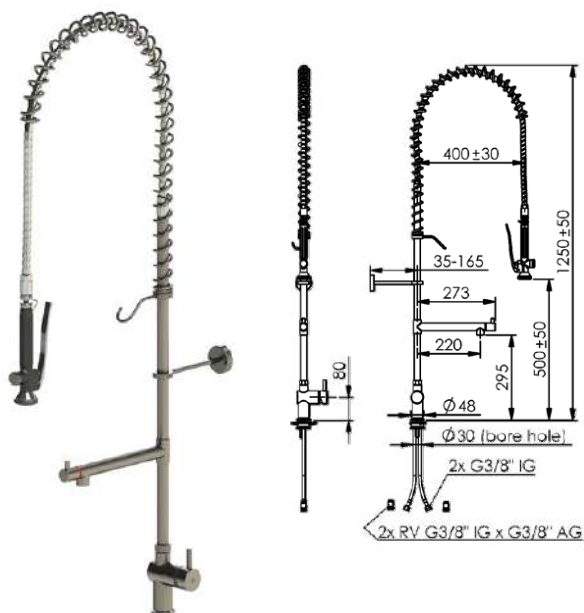



blueline® 3/8"

Bateria prysznicowa; Stal nierdzewna 316 L
Pre-rinse unit; 316 L Stainless steel

Nr kat.	op.	PLN	EUR
EC-321-102-220-295	1	3 779,24	-

- Wersja tylko do wysokiego ciśnienia, ciśnienie robocze 1-6 bar
- Uchwyt termoizolacyjny
- Pistolet natryskowy z głowicą natryskową ze stali szlachetnej, sitko z tworzywa sztucznego
- Obrotowa wylewka Premium z możliwością blokady na zaworze obrotowym, występ P = 250 mm / wysokość H = 195 mm
- Regulacja temperatury i przepływu z nowoczesnym wkładem ceramicznym eco (2-stopniowa funkcja oszczędzania wody)
- Elastyczne węże przyłączeniowe 2 x 500 mm, nakrętka złączkowa 3/8"
- Łatwy w montażu system mocowań
- Zawory zwrotne zapobiegają cyrkulacji między ciepłą i zimną wodą oraz zasysaniu brudnej wody
- Montaż naścienny bez widocznego gwintu (możliwość skrócenia 35 do 165 mm)
- Materiał stal nierdzewna
- Odporność na temperaturę do 80°C
- Otwór w blacie roboczym Ø30 mm
- Wszystkie spawy są wolne od kadmu i ołowiu
- Wszystkie uszczelki są zgodne z przepisami KTW

- Version for high pressure only, operating pressure 1-6 bar
- Heat insulating handle
- Spray gun with stainless steel spray head, plastic strainer
- Premium swivel spout lockable at the swivel valve, projection P = 250 mm / height H = 195 mm
- Temperature and flow control with modern eco ceramic cartridge (2 stage water saving function)
- Flexible connection hoses 2 x 500 mm, union nut 3/8"
- Easy-to-install fastening system
- Non-return valves prevents circulation between hot and cold water and suctioning of dirty water
- Wall mount without visible thread (can be shortened 35 to 165 mm)
- Material stainless steel
- Hot water resistant up to 80°C
- Worktop bore hole Ø30 mm
- All solders are free of cadmium and lead
- All seals comply with the KTW regulations

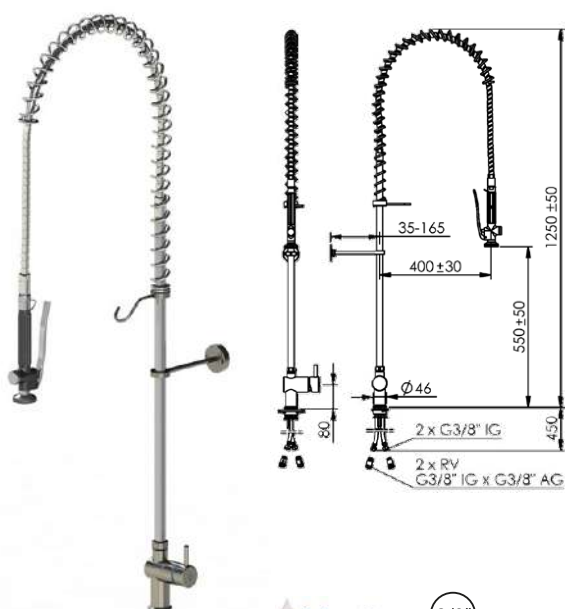

blueline® 3/8"

Bateria prysznicowa; Stal nierdzewna 316 L
Pre-rinse unit; 316 L Stainless steel

Nr kat.	op.	PLN	EUR
EC-321-102-000	1	3 237,72	-

- Wersja tylko do wysokiego ciśnienia, ciśnienie robocze 1-6 bar
- Uchwyt termoizolacyjny
- Pistolet natryskowy z głowicą natryskową ze stali szlachetnej, sitko z tworzywa sztucznego
- Regulacja temperatury i przepływu z nowoczesnym wkładem ceramicznym eco (2-stopniowa funkcja oszczędzania wody)
- Elastyczne węże przyłączeniowe 2 x 500 mm, nakrętka złączkowa 3/8"
- Łatwy w montażu system mocowania
- Zawory zwrotne zapobiegają cyrkulacji pomiędzy ciepłą i zimną wodą oraz zasysaniu brudnej wody
- Montaż naścienny bez widocznego gwintu (możliwość skrócenia 35 do 165 mm)
- Materiał stal nierdzewna
- Odporność na działanie gorącej wody do 80°C
- Otwór w blacie roboczym Ø30 mm
- Wszystkie spawy są wolne od kadmu i ołowiu
- Wszystkie uszczelki są zgodne z przepisami KTW

- Version for high pressure only, operating pressure 1-6 bar
- Heat insulating handle
- Spray gun with stainless steel spray head, plastic strainer
- Temperature and flow control with modern eco ceramic cartridge (2 stage water saving function)
- Flexible connection hoses 2 x 500 mm, union nut 3/8"
- Easy-to-install fastening system
- Non-return valves prevents circulation between hot & cold water and suctioning of dirty water
- Wall mount without visible thread (can be shortened 35 to 165 mm)
- Material stainless steel
- Hot water resistant up to 80°C
- Worktop bore hole Ø30 mm
- All solders are free of cadmium and lead
- All seals comply with the KTW regulations

KUP ON-LINE

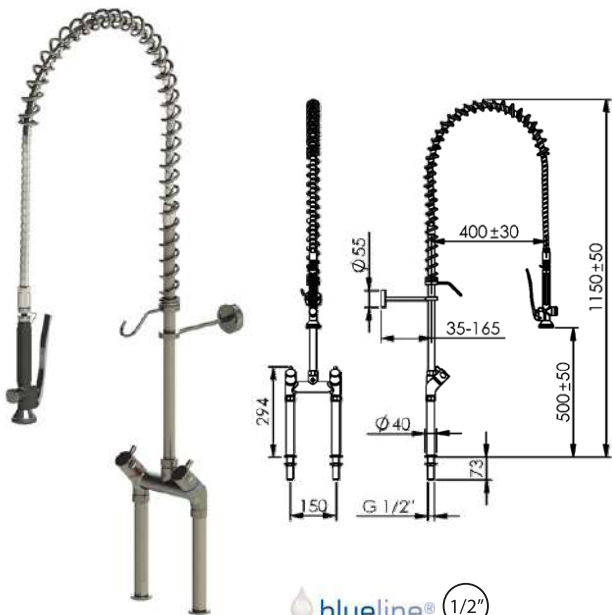

Bateria prysznicowa; Stal nierdzewna 316 L
Pre-rinse unit; 316 L Stainless steel

Nr kat.	op.	PLN	EUR
EC-325-201-000	1	3 443,48	-

- Bateria mieszakowa: Dwukurkowa
- Ciśnienie robocze 1 - 6 bar (14,5 - 87 psi)
- Tylko dla wysokiego ciśnienia
- Głowica ceramiczna w mieszaczu i wylewce
- Kurki izolowane termicznie
- Ergonomiczny pistolet natryskowy z metalową głowicą, sitko z tworzywa sztucznego, z wbudowanym opóźnieniem zamknięcia dla zredukowania skoków ciśnienia
- Zawory zwrotne DW15/DN10, 1/2" żeński x 1/2" męski
- Sprężyna z nierdzewnej stali szlachetnej
- Wspornik ścienny, bez widocznego gwintu (35 mm do 165 mm)
- Hak z obniżonej stali nierdzewnej do szybkiego mocowania i odbioru natrysku ręcznego
- Wąż Aggraff, 1000 mm, stal nierdzewna o wysokiej wydajności
- Podłączenie/Instalacja: Otwór w blacie roboczym 2 x Ø22mm
- Natrysk ręczny 9 - 15 l/min (2 - 4 bar, 29 - 58 psi)
- Przepływ z obrotową wylewką 19 - 27 l/min (2 - 4 bar, 29 - 58 psi)
- Wszystkie spawy są wolne od kadmu i ołowiu
- Odporność na temperaturę do 80°C
- Solidna konstrukcja: Wszystkie elementy płukania wstępnego zostały zaprojektowane do użytku w profesjonalnym środowisku pracy
- Zwiększona powierzchnia robocza: Sprężyna ze stali nierdzewnej zapewniająca dużą swobodę pracy
- Skoncentrowany strumień wody dla idealnego efektu płukania wstępnego
- Zawory zwrotne zapobiegają cyrkulacji pomiędzy ciepłą i zimną wodą oraz cofaniu się brudnej wody

- Mixer tap: Two-handle mixer tap
- Operating pressure 1 - 6 bar (14.5 - 87 psi)
- For high pressure only
- Ceramic headworks - mixer, spout
- Heat insulating handles
- Ergonomic hand spray with metal spray head, plastic strainer, with integrated closing delay for reduced pressure surges
- Non-return valves DW15/DN10, 1/2" female x 1/2" male
- Stainless steel spring
- Wall bracket, no visible thread (35mm to 165mm)
- Down-graded stainless steel hook for quick fixing and taking of hand spray
- Hose: Stainless steel high-performance Aggraff-hose, 1000mm
- Connection/Installation: Worktop bore hole 2 x Ø22mm
- Flow rate hand spray 9 - 15 l/min (2 - 4 bar, 29 - 58 psi)
- Flow rate swivel spout 19 - 27 l/min (2 - 4 bar, 29 - 58 psi)
- All solders are free of cadmium and lead
- Hot water resistant up to 80°C
- Robust Design: All components of the pre-rinse are designed for use in professional working environment
- Extended work area: Stainless steel spring for large work area
- Concentrated water jet for ideal pre-rinsing result
- Non-return valves prevent the circulation between hot and cold water as well as the backflow of dirty water

- Bateria mieszakowa: Dwukurkowa
- Ciśnienie robocze 1 - 6 bar (14,5 - 87 psi)
- Tylko dla wysokiego ciśnienia
- Głowica ceramiczna w mieszaczu i wylewce
- Kurki izolowane termicznie
- Ergonomiczny pistolet natryskowy z metalową głowicą, sitko z tworzywa sztucznego, z wbudowanym opóźnieniem zamknięcia dla zredukowania skoków ciśnienia
- Obrotowa wylewka Premium (360°) z zaworem czołowym dla komfortowej obsługi, wys. A = 150mm / 220mm / 270mm, wys. H = 285mm
- Zawory zwrotne DW15/DN10, 1/2" żeński x 1/2" męski
- Sprężyna ze stali nierdzewnej
- Wspornik ścienny, bez widocznego gwintu (35mm do 165mm)
- Hak z obniżonej stali nierdzewnej do szybkiego mocowania i odbioru natrysku ręcznego
- Wąż Aggraff, 1000 mm, stal nierdzewna o wysokiej wydajności
- Podłączenie/Instalacja: Otwór w blacie roboczym 2 x Ø22mm
- Natrysk ręczny 9 - 15 l/min (2 - 4 bar, 29 - 58 psi)
- Wydajność wylewki obrotowej 19 - 27 l/min (2 - 4 bar, 29 - 58 psi)
- Odporność na temperaturę do 80°C
- Solidna konstrukcja: Wszystkie elementy płukania wstępnego zostały zaprojektowane do użytku w profesjonalnym środowisku pracy
- Zwiększona powierzchnia robocza: Sprężyna ze stali nierdzewnej zapewniająca dużą swobodę pracy
- Skoncentrowany strumień wody dla idealnego efektu płukania wstępnego
- Zawory zwrotne zapobiegają cyrkulacji pomiędzy ciepłą i zimną wodą oraz cofaniu się brudnej wody

- Mixer tap: Two-handle mixer tap
- Operating pressure 1 - 6 bar (14.5 - 87 psi)
- For high pressure only
- Ceramic headworks - mixer, spout
- Heat insulating handles
- Ergonomic hand spray with metal spray head, plastic strainer, with integrated closing delay for reduced pressure surges
- Premium swivel spout (360°) with front valve for comfortable operation, Projection A = 150mm / 220mm / 270mm, Height H = 285mm
- Non-return valves DW15/DN10, 1/2" female x 1/2" male
- Stainless steel spring
- Wall bracket, no visible thread (35mm to 165mm)
- Down-graded stainless steel hook for quick fixing and taking of hand spray
- Hose: Stainless steel high-performance Aggraff-hose, 1000mm
- Connection/Installation: Worktop bore hole 2 x Ø22mm
- Flow rate hand spray 9 - 15 l/min (2 - 4 bar, 29 - 58 psi)
- Flow rate swivel spout 19 - 27 l/min (2 - 4 bar, 29 - 58 psi)
- Hot water resistant up to 80°C
- Robust Design: All components of the pre-rinse are designed for use in professional working environment
- Extended work area: Stainless steel spring for large work area
- Concentrated water jet for ideal pre-rinsing result
- Non-return valves prevent the circulation between hot and cold water as well as the backflow of dirty water

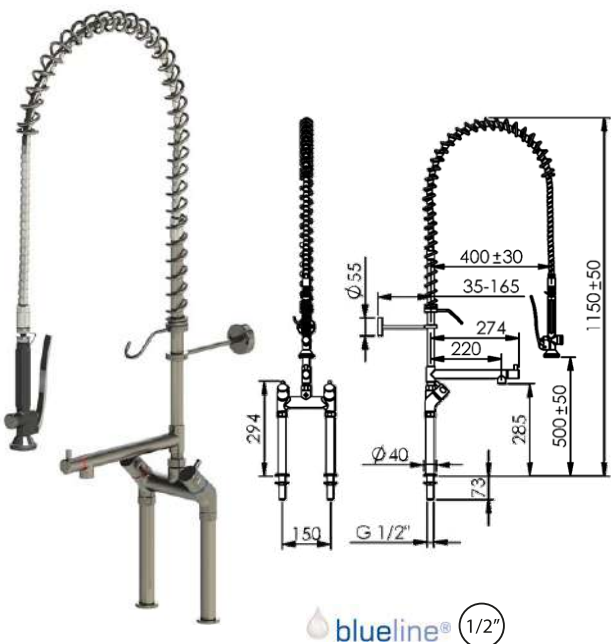
Bateria prysznicowa; Stal nierdzewna 316 L
Pre-rinse unit; 316 L Stainless steel

Nr kat.	op.	PLN	EUR
EC-325-201-220-285	1	3 985,11	-

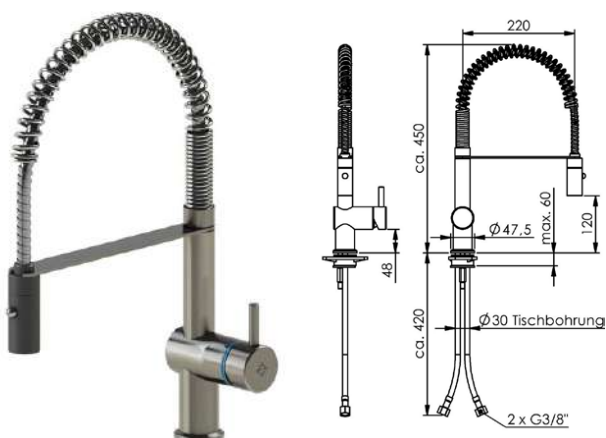

blueline® 3/8"

Bateria prysznicowa; Stal nierdzewna 316 L
Pre-rinse unit; 316 L Stainless steel

Nr kat.	op.	PLN	EUR
EC-361-101-230-125	1	2 494,62	-

- Wersja tylko dla wysokiego ciśnienia, ciśnienie robocze 1-6 bar
- Pistolet natryskowy Soft Touch przełącza strumień normalny na natryskowy
- Wysięg 230 mm
- Wysokość pistoletu 125 mm
- Wysokość całkowita 450 mm
- Regulacja temperatury i przepływu z nowoczesnym wkładem ceramicznym eco
- Elastyczne węże przyłączeniowe, nakrętka łączkowa 3/8".
- Łatwy w montażu system mocowania z prętem M8 x 140 mm do blatów o grubości do ok. 50 mm
- Zawory zwrotne zapobiegają cyrkulacji pomiędzy ciepłą i zimną wodą oraz zasysaniu brudnej wody
- Materiał stal szlachetna
- Odporność na temperaturę do 80°C
- Przepływ 10 l/min, ciśnienie przepływu 3 bar
- Wszystkie spawy są wolne od kadmu i ołowiu
- Otwór w blacie roboczym Ø30 mm

- Version for high pressure only, operating pressure 1-6 bar
- Spray gun Soft Touch switches from normal to spray jet
- Projection 230 mm
- Height spray gun 125 mm
- Total height 450 mm
- Temperature and flow control with modern eco ceramic cartridge
- Flexible connection hoses, union nut 3/8"
- Easy-to-install fastening system with rod M8 x 140 mm for worktop thickness of up to approx. 50 mm
- Non-return valves prevents circulation between hot and cold water and suctioning of dirty water
- Material stainless steel
- Hot water resistant up to 80°C
- Flow rate 10 l/min, flow pressure 3 bar
- All solders are free of cadmium and lead
- Worktop bore hole Ø30 mm

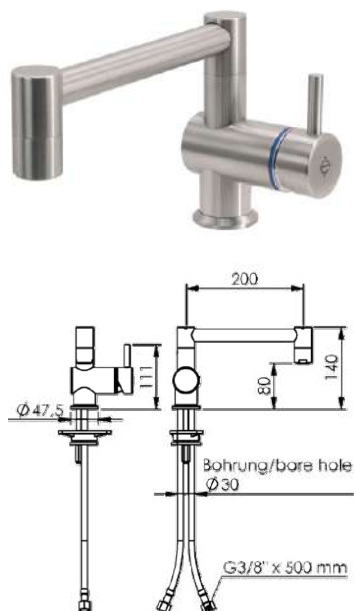

blueline® 3/8"

Kran barowy; Stal nierdzewna 317 L
Bar counter tap; 317 L Stainless steel

Nr kat.	op.	PLN	EUR
EC-251-101-200-140	1	2 157,93	-

- Wersja tylko do wysokiego ciśnienia, ciśnienie robocze 1-6 bar
- Uchwyt izolowany termicznie
- Zredukowana wysokość
- Obrotowa wylewka HU z JetSafe (zabezpieczenie przed kapaniem)
- Wysięg 200 mm, wysokość wylewki 80 mm
- Wysokość całkowita 140 mm
- Regulacja temperatury i przepływu z nowoczesnym wkładem ceramicznym eco (2-stopniowa funkcja oszczędzania wody)
- Przepływ ok. 23 l/min, ciśnienie przepływu 3 bar
- Elastyczne węże przyłączeniowe 2 x 500 mm, nakrętka łączkowa 3/8"
- Łatwy w montażu system mocowania
- Materiał stal szlachetna
- Otwór w blacie roboczym Ø30 mm
- Wszystkie spawy są wolne od kadmu i ołowiu
- Wszystkie uszczelki odpowiadają przepisom KTW

- Version for high pressure only, operating pressure 1-6 bar
- Heat insulating handle
- Reduced height
- Swivelling HU-spout with JetSafe (drip protection)
- Projection 200 mm, spout height 80 mm
- Total height 140 mm
- Temperature and flow control with modern eco ceramic cartridge (2 stage water saving function)
- Flow rate approx. 23 l/min, flow pressure 3 bar
- Flexible connection hoses 2 x 500 mm, union nut 3/8"
- Easy-to-install fastening system
- Material stainless steel
- Worktop bore hole Ø30 mm
- All solders are free of cadmium and lead
- All seals comply with the KTW regulations



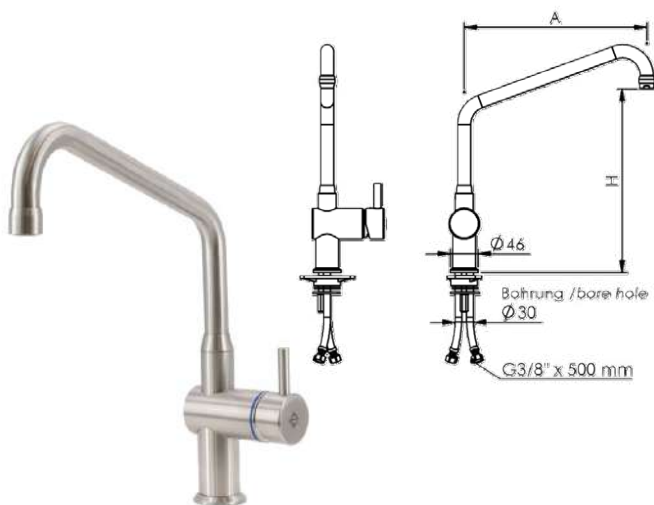

3/8"

Kran; Stal nierdzewna 318 L
Water tap; 318 L Stainless steel

Nr kat.	op.	PLN	EUR
EC-201-101-250-300	1	2 072,24	-

- Wersja tylko do wysokiego ciśnienia, ciśnienie robocze 1-6 bar
- Uchwyt izolowany termicznie
- Obrotowa wylewka CWU z JetSafe (zabezpieczenie przed kapaniem)
- Regulacja temperatury i przepływu z nowoczesnym wkładem ceramicznym eco (2-stopniowa funkcja oszczędzania wody)
- Elastyczne węże przyłączeniowe 2 x 500 mm, nakrętka złączkowa 3/8"
- Łatwy w montażu system mocowań
- Materiał stal szlachetna
- Odporność na temperaturę do 80°C
- Otwór w blacie roboczym Ø30 mm
- Wszystkie spawy są wolne od kadmu i ołowiu
- Wszystkie uszczelki spełniają wymagania przepisów KTW

- *Version for high pressure only, operating pressure 1-6 bar*
- *Heat insulating handle*
- *Swiveling HU-spout with JetSafe (drip protection)*
- *Temperature and flow control with modern eco ceramic cartridge (2 stage water saving function)*
- *Flexible connection hoses 2 x 500 mm, union nut 3/8"*
- *Easy-to-install fastening system*
- *Material stainless steel*
- *Hot water resistant up to 80°C*
- *Worktop bore hole Ø30 mm*
- *All solders are free of cadmium and lead*
- *All seals comply with the KTW regulations*

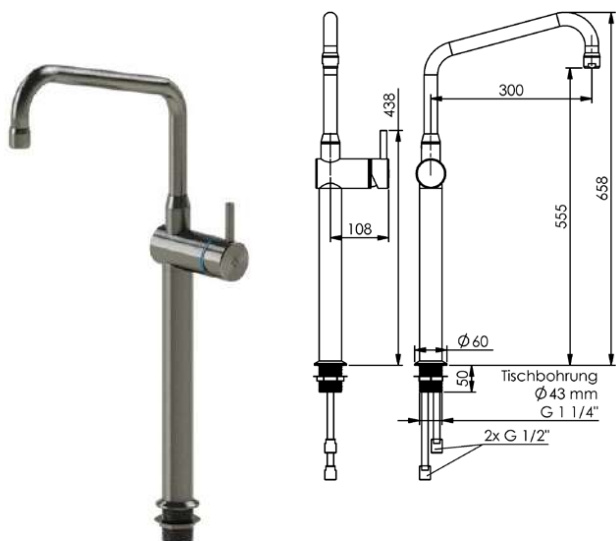

1/2"

Kran; Stal nierdzewna 319 L
Water tap; 319 L Stainless steel

Nr kat.	op.	PLN	EUR
EC-221-101-300-555	1	3 151,30	-

- Wersja tylko do wysokiego ciśnienia, ciśnienie robocze 1-6 bar
- Uchwyt izolowany termicznie
- Obrotowa wylewka CWU z JetSafe (zabezpieczenie przed kapaniem)
- Regulacja temperatury i przepływu za pomocą nowoczesnego wkładu ceramicznego o dużym przepływie
- Podłączenie poprzez 2 x rury miedziane z gwintem 1/2"
- Łatwy w montażu system z nakrętką mocującą i króćcem przyłączeniowym G 1 1/4" x 50 mm
- Materiał stal szlachetna
- Odporność na temperaturę do 80°C
- Otwór w blacie roboczym Ø43 mm
- Wszystkie spawy są wolne od kadmu i ołowiu
- Wszystkie uszczelki spełniają wymagania przepisów KTW

- *Version for high pressure only, operating pressure 1-6 bar*
- *Heat insulating handle*
- *Swiveling HU-spout with JetSafe (drip protection)*
- *Temperature and flow control with modern ceramic cartridge with high flow rate*
- *Connection via 2 x copper pipes with 1/2" connection thread*
- *Easy-to-install system with fixing nut and connection piece with G 1 1/4" x 50 mm*
- *Material stainless steel*
- *Hot water resistant up to 80°C*
- *Worktop bore hole Ø43 mm*
- *All solders are free of cadmium and lead*
- *All seals comply with the KTW regulations*



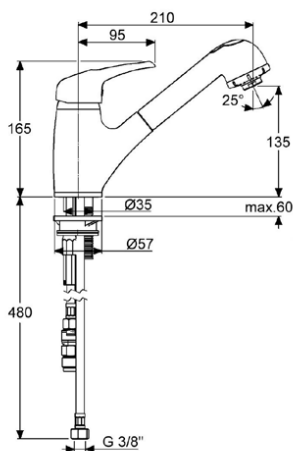

3/8"

Kran; Mosiądz
Water tap; Brass

Nr kat.	op.	PLN	EUR
EC-6492-90	1	972,31	-

- Dwustopniowy wkład z dyskiem ceramicznym z funkcją eko
- Krótka dźwignia
- Wysięg 210 mm
- Wysokość wylewki 135 mm
- Mosiądz - polerowany na wysoki połysk, chromowany
- Wielkość przepływu 23 (l/min)
- Elastyczne węże przyłączeniowe M15 x G 1" x 350 mm, G 3/8" x 480 mm
- Pręt gwintowany M8
- Montaż do blatu roboczego
- Wszystkie spawy są wolne od kadmu i ołowiu
- Otwór Ø35 mm

- Dual-stage ceramic disc cartridge with eco-position
- Short operating lever
- Projection 210 mm
- Spout height 135 mm
- Brass - high-gloss polished, chrome plated
- Flow rate 23 (l/min)
- Flexible connection hoses M15 x G 1" x 350 mm, G 3/8" x 480 mm
- Threaded rod M8
- Worktop installation
- All solders are free of cadmium and lead
- Bore hole Ø35 mm

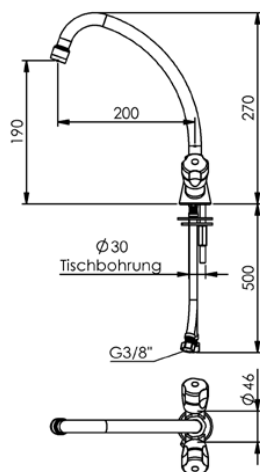

3/8"

Kran; Mosiądz
Water tap; Brass

Nr kat.	op.	PLN	EUR
EC-6480-90	1	453,00	-

- Smarowana głowica z metalowymi kurkami nasadowymi
- Obrotowa wylewka z regulatorem strumienia
- Mosiądz - polerowany na wysoki połysk, chromowany
- Wysięg 200 mm
- Wysokość wylewki 190 mm
- Przepływ 30 (l/min)
- Elastyczne węże przyłączeniowe G 3/8" x 350 mm
- Montaż do blatu roboczego
- Otwór Ø30 mm
- Wszystkie spawy są wolne od kadmu i ołowiu
- Wszystkie uszczelki są zgodne z przepisami KTW

- Lubricated head work with metal cap handles
- Swivel spout with jet regulator
- Brass - high-gloss polished, chrome plated
- Projection 200 mm
- Spout height 190 mm
- Flow rate 30 (l/min)
- Flexible connection hoses G 3/8" x 350 mm
- Worktop installation
- Bore hole Ø30 mm
- All solders are free of cadmium and lead
- All seals comply with the KTW regulations



HENKOVAC

Doskonały wybór dla profesjonalistów!

OPAKOWANIE PRÓŻNIOWE PRZEDŁUŻA OKRES TRWAŁOŚCI PRODUKTÓW, GWARANTUJE JAKOŚĆ, ZAPOBIEGA WYSUSZANIU PRODUKTÓW, CHRONI PRODUKTY PRZED CZYNNIKAMI ZEWNĘTRZNYMI I POPRAWIA HIGIENĘ UŻYTKOWANIE.

Pakowanie próżniowe Henkovac to bardzo opłacalna metoda konserwacji łatwo psujących się produktów spożywczych. Przedłuża okres przydatności do spożycia produktów i jest w pełni zgodna z rygorystycznymi procedurami higienicznymi HACCP.

- Niskie koszty materiałów opakowaniowych i krótki czas przetwarzania
- Najbardziej ekonomiczny i wydajny sposób higienicznego pakowania żywności
- Niezawodna jakość urządzeń: solidne, łatwe w obsłudze i konserwacji
- Wszystkie modele mają higieniczne, łatwe do czyszczenia komory próżniowe oraz łatwo zdejmowane belki uszczelniające i silikonowe pręty
- Intuicyjna cyfrowa jednostka sterująca może automatycznie wykryć optymalny poziom próżni dla każdego produktu. W przypadku produktów o dużej zawartości wilgoci jednostka sterująca zatrzymuje dokładnie odpowiednią ilość wilgoci. Poprawia to kruchość i smak produktów.

Pełna gama maszyn i dostępnych opcji ułatwia wybór rozwiązania dla Twoich potrzeb w zakresie pakowania.



HENKOVAC

BUSCH

Pokowarka próżniowa; Stal nierdzewna, akryl
Vacuum Packaging Machines; Stainless steel, acrylic

Nr kat.	l cm	h cm	w cm	PLN	EUR
T-T2	50	34	37	10 374,00	-
T-T3	55	41	43	14 221,50	-
T-T4	59	46	53	16 748,50	-
T-T6	61	48	63	25 469,50	-

Sterowanie elektroniczne jeden program
Electronic control one program

An excellent choice for professionals!

VACUUM PACKAGING LONG LASTS PRODUCTS, GUARANTEES QUALITY, PREVENTS PRODUCTS FROM DRYING OUT, PROTECTS PRODUCTS AGAINST EXTERNAL FACTORS AND IMPROVES HYGIENE USAGE.

Henkovac vacuum packaging is a very cost effective method of preserving perishable food products. It extends the shelf life of products and is fully compliant with the strict HACCP hygiene procedures.

- *Low packaging material costs and short processing times*
- *The most economical and efficient way to hygienically package food*
- *Reliable equipment quality: robust, easy to operate and maintain*
- *All models have hygienic, easy-to-clean vacuum chambers and easily removable sealing bars and silicone rods*
- *The intuitive digital control unit can automatically detect the optimal vacuum level for each product. In the case of products with a high moisture content, the control unit retains exactly the right amount of moisture. This improves the tenderness and taste of the products*

A complete range of machines and options make it easy to choose a solution for your packaging needs.





Specyfikacja

	T2	T3	T4	T6
Pokrywa	Plaska	Wysoka	Wysoka	Wysoka
Uszczelka	Pojedyncza	Podwójna	Podwójna	Podwójna
Wymiary w mm	371 x 500 x 340	425 x 550 x 410	530 x 590 x 460	625 x 610 x 481
Napięcie	220-240 - 1 - 50/60 Hz	220-240 - 1 - 50/60 Hz	220-240 - 1 - 50/60 Hz	220-240 - 1 - 50/60 Hz
Cyfrowa kontrola czasu	1 Program	1 Program	1 Program	1 Program
Pojemność pompy	4 m ³	8 m ³	16 m ³	16 m ³
Waga	27 kg	41 kg	55 kg	85 kg

Konfiguracje uszczelek

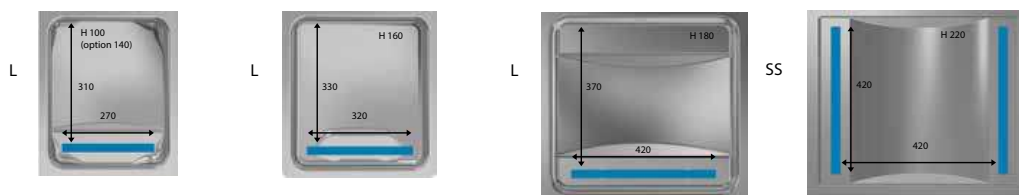

Worek do pakowarek próżniowych (100 szt.); PA/PE
Vacuum bag (100 pcs.); PA/PE

Nr kat.	l cm	w cm	PLN	EUR
T-1525-70	25	15	18,52	-
T-1525-85	25	15	24,27	-
T-2030-70	30	20	29,64	-
T-2030-85	30	20	38,80	-
T-2535-70	35	25	43,30	-
T-2535-85	35	25	56,60	-

Najwyższej jakości worki potwierdzone certyfikatem ISO 9001 • Poziom migracji globalnej jest zgodny z limitem określonym przez prawo
Best quality with the ISO 9001 certificate

KUP ON-LINE



Excalibur
DESIGNER & BEST PROFESSIONAL

100%Chef

KOSTA®

Dehydrator EXCALIBUR 4900 Dehydrator Excalibur 4900

Nr kat.	l cm	w cm	W	kg	PLN	EUR
C1-7003	32	48	600	10	2 635,49	-

9 tac 38 x 38 cm • Horyzontalny przepływ powietrza, system suszenia równoległego • Regulowana temperatura od 33°C do 74°C • Zdejmowane drzwi

9 trays 38 x 38 cm • High air circulation, the system of parallel drying • Adjustable temperature from 33°C to 74°C • Removable doors

Noon - cyrkulator sous vide Noon - circulator sous vide

Nr kat.	l cm	h cm	w cm	W	PLN	EUR
C1-8058	16	31,4	12	1800	5 210,54	-

Tworzywo o zwiększonej wytrzymałości • Wyświetlacz LCD • 29 programów • Możliwość tworzenia własnych programów • Wydajność do 40 l podgrzewanej wody • Możliwość zamontowania na każdym zbiorniku o głębokości minimum 15 cm • Czujnik poziomu wody zapobiega uszkodzeniu urządzenia (brak płynu podatnego na zakamienie) • Urządzenie zapamiętuje czas i temperaturę gotowania w przypadku przerwy w dostawie prądu • System zwiększonej efektywności cyrkulacji wody w pojemniku z użyciem rurki z obciążeniem



GRANT

GRANT

Vortice - cyrkulator sous vide Vortice - circulator sous vide

Nr kat.	l cm	h cm	w cm	W	PLN	EUR
T-GTV01	33	12	17	1300	6 869,00	-

Kompaktowa konstrukcja • Wyświetlacz LCD • Możliwość zapisania do 3 programów • Do każdego naczynia o objętości maks. 50 l • Możliwość zamontowania na każdym zbiorniku o głębokości minimum 15 cm • Timer z alarmem • W zestawie z klamrą i demontowalną kłatką • Minimalne zanurzenie: 9 cm • 2 lata gwarancji

Pasto - wanna sous vide GN 1/1 Pasto - sous vide bath GN 1/1

Nr kat.	l cm	h cm	w cm	cap l	W	PLN	EUR
T-GTP01	55	33	23	26	1400	6 400,63	-

Szybkie nagrzewanie • Timer od 0 do 999 minut z alarmem • W zestawie pokrywa • odporny na zanieczyszczenia kamieniem • łatwy w czyszczeniu • Brak ruchomych części

Fast heat up time • Countdown timer 0 to 999 mins with alarm • Supplied with a lid • Resistant to scaling • Easy to clean • No movable parts



100%Chef

Pojemnik na ciekły azot Liquid nitrogen container 10l

Nr kat.	cap l	PLN	EUR
C1-1206	10	4 106,61	-
C1-1208	30	6 264,20	-

Pozwalają bezpiecznie przechowywać ciekły azot • W zestawie pokrowiec

Allows to safely store the liquid nitrogen



100%Chef

Nitro Bowl XXL; szkło borosilikatowe Nitro Bowl XXL; borosilicate glass

Nr kat.	Ø cm	cap l	PLN	EUR
C1-1229	22	2,5	717,40	-

Niezwykle trwałe szkła odporne na szok termiczny
Thermal shock resistant glass. Case included.



100%Chef

Nitro Bowl; szkło borosilikatowe Nitro Bowl; borosilicate glass

Nr kat.	Ø cm	cap l	PLN	EUR
C1-1218	13	0,5	264,34	-

Niezwykle trwałe szkła odporne na szok termiczny
Thermal shock resistant glass. Case included.





Aromatyzator Aladin 007 Flavour; AI.
Professional Flavouring Smoker Super-Aladin; AI.

Nr kat.	col	PLN	EUR
C1-1092	złoty	1 384,60	-

Zestaw zawiera: aromatyzator, 100 ml roztworu spożywczego do tworzenia bąbelków, 4 beznikotynowe smakowe wkłady parowe, 2 akumulatory 9 V, kabel do ładowania

Set includes: Aromatizer, 100 ml bubbling solution, 4 nicotine-free flavored steam cartridges, 2 9 V batteries, charging cable



Wkład z aromatem smakowym
Taste-flavoured cartridge

Nr kat.		PLN	EUR
C1-10078	mięta	51,52	-
C1-10081	trawa cytrynowa	51,52	-
C1-10093	neutralny	51,52	-
C1-10095	kawa czekoladowa	51,52	-
C1-10096	cynamon	51,52	-
C1-10097	lawenda	51,52	-

Beznikotynowy • Parowy • Wystarcza do 120 użyc • Pasuje do C1-1092
Nicotine-free • Steam • Enough for 120 uses • Fits C1-1092



Wędzarka/aromatyzator Genius Bubble - Kit
Genius Bubble Smoker - Kit

Nr kat.	PLN	EUR
C1-10000	278,58	-

Tworzy bąbelki spożywcze na napojach, potrawach, naczyniach
• Możliwość wędzenia trocinami, olejkami eterycznymi
• Zestaw zawiera: aromatyzator, roztwór spożywczy do baniek, trociny bukowe

Creates food bubbles on drinks, dishes, dishes • Possibility of smoking sawdust, essential oils • Set includes: aromatizer, bubble food solution, beech sawdust



Aromatyzator Super-Aladin AI
Professional Flavouring Smoker Super-Aladin; AI.

Nr kat.		PLN	EUR
C1-1003		1 200,69	-
C1-1031	stacja	314,51	-



Aromatyzator Aladin 007; AI
Professional Flavouring Smoker Aladin 007; AI.

Nr kat.	PLN	EUR
C1-1009	1 200,69	-

Przykrywka C1-1029 w zestawie • Zalecany do aromatyzowania koktajli

Supplied with C1-1029 lid • Recommended for flavouring cocktails



Pokrywa do aromatyzowania GN 1/1; 18/10
Lid GN 1/1 for aromatizator; 18/10

Nr kat.	l cm	w cm	PLN	EUR
C1-1033	53	32,5	464,44	-

Wygodne aromatyzowanie większej ilości żywności • Produkt nie zawiera pojemnika i aromatyzera

Easy flavouring large amount of food • Doesn't include the pan and the aromatizer

KUP ON-LINE

Filtry do aromatyzera Filters for aromatizer



Nr kat.		PLN	EUR
C1-1005	rozmiar XS	14,25	-
C1-1006	rozmiar XL	18,69	-

Opakowanie 5 szt.
5 pcs. pack



Trociny wędzarnicze; drewno z beczek po Jack Daniels Chips; Jack Daniels barrel

Nr kat.		g	PLN	EUR
C1-10-0042	Jack Daniel's	80	36,21	-
C1-1004	bukowe	80	26,43	-
C1-1027	dębowe	80	29,03	-



Pokrywa do aromatyzowania; szkło borosilikatowe Cover; borosilicate glass

Nr kat.		Ø cm	h cm	g	op.	PLN	EUR
C1-1022-6	niska	9	9	80	6	113,17	-
C1-1013-6	niska	14	14	170	6	173,78	-
C1-1015-6	niska	18	15	80	6	214,20	-
C1-1035	wysoka	18,5	25	80	2	444,59	-

Pakowane po 6 szt. • Cena za 1 szt.
6 pcs. pack • price for 1 piece



Wióry wędzarnicze; drewno z beczek po Jack Daniels Scobs; Jack Daniel's barrel

Nr kat.	kg	PLN	EUR
C1-1028	0,85	151,02	-



Zapasy korek silikonowy (kpl. 6 szt) Replacement silicon valves (6 pcs)

Nr kat.		Ø cm	g	PLN	EUR
C1-1029	przykrywka	12	80	75,41	-
C1-1019	korek zapasowy	80	151,02	-	-

Korek w zestawie 6 szt.

Silicone valve - 6 pcs. pack



Butelka do aromatyzowania; szkło Dash bottle; glass

Nr kat.	cap ml	PLN	EUR
BPR-160-100	100	50,54	-



Butelka do aromatyzowania; szkło Dash bottle; glass

Nr kat.	cap ml	PLN	EUR
BPR-00-230	230	55,00	-



Teppan Nitro Salva G; 18/10, PP Teppan Nitro Salva G; 18/10, PP

Nr kat.	l cm	w cm	cap l	PLN	EUR
C1-1202	42	26	2	1 427,62	-

300 ml ciekłego azotu chłodzi powierzchnię do -100°C w zaledwie 2 minuty • Posiada dwie komory o wym. 27 x 21 cm • Jeden wkład ze stali nierdzewnej w zestawie

300 ml liquid nitrogen cools down the surface to -100°C in 2 min. • 2 compartments 27 x 21 cm • Supplied with 1 stainless steel insert



Mini Teppan Nitro Salva-G; 18/10, PP Mini Teppan Nitro Salva G; 18/10, PP

Nr kat.	l cm	w cm	PLN	EUR
C1-1221	12	12	377,55	-

300 ml ciekłego azotu chłodzi powierzchnię do -100°C w zaledwie 2 minuty

300 ml liquid nitrogen cools down the surface to -100°C in 2 min.

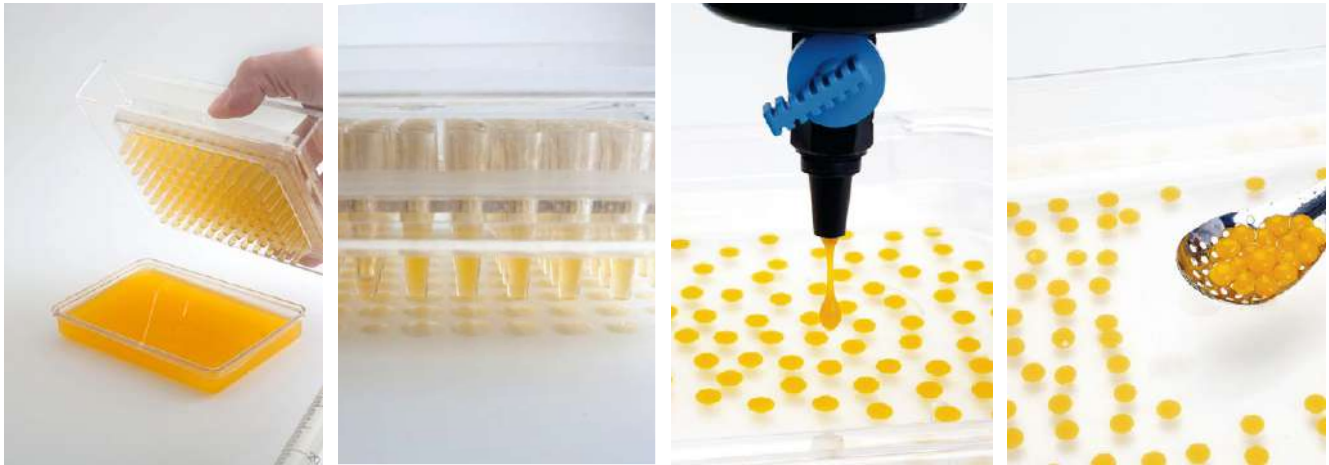

100%Chef

Caviar-Box

Dyspenser do sferyfikacji Caviar Box; PC
Spherification dispenser Caviar Box; PC

Nr kat.	l cm	w cm	PLN	EUR
C1-2002	12	12	623,14	-
C1-2003	3 zapasowe uszczelki	12	90,57	-

Skrapla 96 kropelek w jednym momencie



100%Chef

Dyspenser do sferyfikacji Reverse Sphere
Spherification dispenser Reverse Sphere

Nr kat.	h cm	w cm	cap l	PLN	EUR
C1-20-0006	20	8	0,5	302,04	-

W zestawie 3 końcówki: 6, 8 i 10 mm i łyżka cedzakowa

Supplied with 3 sizes of nozzles: 6, 8 i 10 mm and the skimmer spoon



Łyżka Lotus; 18/10
Lotus spoon; 18/10

Nr kat.	l cm	PLN	EUR
AB-1162	20,5	23,99	-



100%Chef

Kondensator suchego lodu
Dry Ice condensator

Nr kat.	PLN	EUR
C1-1205	1 434,80	-

Nakładka do butli CO2 z syfonem • Suchy lód powstaje w ciągu 1 min w formie tabletki o średnicy 5 cm i wysokości 2 cm (30 g)

A tool to CO2 cylinder • It creates dry ice Ø 5 cm and 2 cm high

KUP ON-LINE





Zestaw Foam Kit Deluxe Foam Kit Deluxe

Nr kat.	PLN	EUR
C1-5052	212,24	-

Tworzy pianę w ciągu kilku sekund • Działa przy małych ilościach płynu • Zasilany dwoma bateriami 1,5V LR20

Creates a foam in seconds • Works with small amounts of liquid • Powered by two 1.5V LR20 batteries



Mieszanka do tworzenia bąbelków Bubble Forming Mixture

Nr kat.	cap ml	PLN	EUR
C1-10089	200	206,08	-

Roztwór spożywczy • Przyjazny dla vegan • Bańka/bąbelki utrzymują się do 3 minut • Bezsmałowa • Wystarcza na wykonanie ponad 1000 baniek

Food Grade Solution • Vegan Friendly • Bubble/bubbles last up to 3 minutes • Tasteless • Enough to make more than 1000 bubbles



Turning Kit Turning Kit

Nr kat.	l cm	w cm	g	PLN	EUR
C1-5004	12	12	80	445,58	-

W zestawie: cylinder 4 cm, cylinder 1,5 cm oraz stożek 1-4 cm

The set of: 4 cm cylinder, 1,5 cm cylinder and 1-4 cm cone



Spaghetti Kit Spaghetti Kit

Nr kat.	l cm	w cm	PLN	EUR
C1-3001	12	12	120,80	-

Zestaw zawiera: pojemnik, przystawkę do syfonu i pięć rurek o długości 100 cm

The set of: a container, a tool for siphone and 5 100 cm long pipes



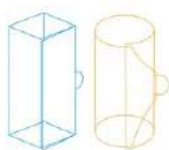

100%Chef

Formy jednorazowe; PET
One use mould - cuboid; PET

Nr kat.		Ø cm	h cm	w cm	PLN	EUR
C1-60-0007	prostokąt		4	2	48,35	-
C1-60-0009	prostokąt		8	2	63,66	-
C1-60-0004	walec	2,5	4		41,70	-
C1-60-0006	walec	2,5	8		55,95	-



100%Chef

Podstawka pod formy (3 szt.); PET
Base fo mould (3 pcs.); PET

Nr kat.		l cm	w cm	PLN	EUR
C1-60-0010	walec	27	18	41,50	-
C1-60-0012	prostokąt	27	18	41,50	-



100%Chef

Pinceta; 18/10
Tweezers; 18/10

Nr kat.	l cm	PLN	EUR
C1-P3407	14	37,41	-
C1-P3436	20	43,19	-
C1-P3443	powł. tytanowa 20	79,10	-



100%Chef

Mini szpatuła; 18/10
Mini spatula; 18/10

Nr kat.	l cm	PLN	EUR
C1-P6403	16	21,25	-



100%Chef

Wycinarka - owal i koło; 18/10
Decoration knife oval/circle; 18/10

Nr kat.	l cm	PLN	EUR
C1-P6496	20	64,44	-

Śr. koła: 1,3 cm; wym. owalu: 0,8 x 1,8 cm
Ring ø 1,3 cm; oval 0,8 x 1,8 cm



Syfon Kayser; 18/10
Siphon Kayser; 18/10

Nr kat.	cap ml	PLN	EUR
T-BS4051	500	431,00	-
T-BS4101	1000	456,00	-



Naboje do syfonu (kpl. 10szt.)
Cartridges for siphon (10 pcs)

Nr kat.	PLN	EUR
T-BSN-1111	25,00	-



Dynamic to bardzo szeroki wybór wysokiej jakości urządzeń. Francuska marka Dynamic przywiązuje niezwykłą wagę do dbałości o szczegóły, jakości i precyzji. To 58 lat tradycji niezawodności.

Dynamic offers a very wide range of high quality devices. The French Dynamic brand attaches great importance to attention to detail, quality and precision. It's 58 years of tradition and reliability.

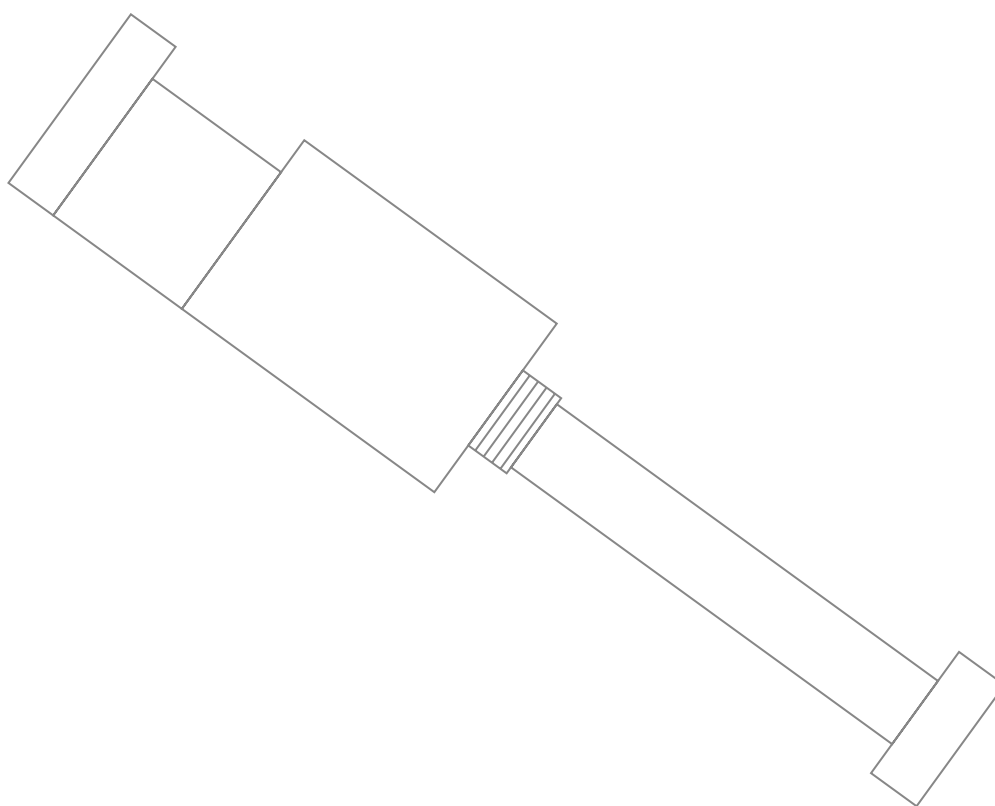

KUP ON-LINE



niezawodność

Prosty design, niezawodna konstrukcja i najwyższej jakości materiały użyte do produkcji zapewniają funkcjonalność i trwałość urządzeń Dynamic. Dzięki najnowszej technologii są niezwykle wydajne.

reliability: Simple and reliable design and the highest quality materials used in production ensure functionality and durability of Dynamic devices. Thanks to the exceptional technology, they are extremely efficient.

innowacja

Marka Dynamic jako twórca miksera jest liderem na światowym rynku urządzeń gastronomicznych. Posiada wiele unikatowych rozwiązań, które są dostępne wyłącznie w Dynamic.

innovation: The Dynamic brand, as the creator of mixers, is a leader on the global catering equipment market. It has many unique solutions that are only available in Dynamic.

higiena

Dynamic to wielofunkcyjne urządzenia i specjalistyczne akcesoria. Są one higieniczne, łatwe w czyszczeniu i niezwykle proste w obsłudze.

Dynamic offers multifunctional devices and specialised accessories. They are hygienic, easy to clean and incredibly easy to use.

DYNAMIX®

JUNIOR



MASTER

SERIA SMX



DYNACUBE



KUP ON-LINE

BLEND & MIX



WYDAJNOŚĆ DO 300 KG NA GODZINĘ LUB 400 PORCJI | CAPACITY UP TO 300 KG PER HOUR OR 400 PORTIONS

Higiena: Wszystkie demontowalne części i akcesoria można myć w zmywarce.

Komfort: Cichy silnik: 50 dB bez wibracji.

Użyteczność: Zaprojektowany do użytku przez osoby prawo- i leworęczne.

Wydajność: Zwiększona wydajność dzięki dużym tarczom (największa średnica na rynku).

Jakość: Tarcze wykonane ze stali nierdzewnej.

Ekologia: Ponad 90% komponentów nadaje się do recyklingu.

Hygiene: All accessories are dishwasher safe.

Comfort: Quiet motor: 50 dB without vibration.

Versatility: Designed for right- and left-handed use.

Performance: Increased performance with large discs (largest diameter on the market).

Quality: The discs are made of stainless steel.

Ecology: More than 90% of the components are recyclable.

BLEND & MIX SZATKOWNICA DO WARZYW



Model opatentowany



Szatkowica do warzyw; 18/10, poliwęglan Vegetable slicer; 18/10, polycarbonate

Nr kat.	W	obr./m	PLN	EUR
DY-CL121	1100	320/720	11 579,31	-

Dwa otwory przystosowane do wszystkich rodzajów warzyw: 1. szeroki otwór o powierzchni 217 cm² do dużych warzyw, (kapusta, seler); 2. cylindryczny otwór o ϕ 6,5 cm do długich i delikatnych warzyw (cukinia, ogórki) • Boczny wylot na żywność o szer. 20 cm, pozwalający na podłożenie poj. GN o gł. do 20 cm • Duży wybór dysków ze stali nierdzewnej do: szatkowania, tarcia, julienne, krojenia w kostkę lub robienia frytek • Zwiększona produktywność dzięki największym na rynku tarczom o średnicy 22,5 cm. • Wszystkie części mające kontakt z żywnością można łatwo zdemonstrować i myć w zmywarce: komora cięcia, popychacz, obręcz i uchwyt popychacza • Magnetyczna kontrola instalacji niezbędnych elementów dla całkowitego bezpieczeństwa operatora

Two hoppers to adapt to all types of vegetables: a wide hopper of 217 cm² for bulky vegetables such as cabbage, celeriac and a cylindrical hopper of ϕ 6.5 mm for long and delicate vegetables (zucchini, cucumbers) • A side food chute with a 20 cm passage to install a deep gn collection container (20 cm) • Wide variety of cuts: a large choice of stainless steel discs for slicing, grating, julienne, dicing or making french fries • Increased productivity thanks to the largest discs on the market with a diameter of 22.5 mm. • All parts in contact with food are easily removable and dishwasher-proof for quick cleaning: cutting chamber, pusher, hooper and pusher handle • Automatic magnetic detection for total operator safety

BLEND & MIX CUTTER-WILK



Cutter-Wilk; 18/10, poliwęglan Food processor; 18/10, polycarbonate

Nr kat.	W	obr./m	PLN	EUR
DY-CL222	1100	320/720	11 707,16	-

Do produkcji farszy mięsnych i rybnych, tatarów, majonezów, dressingów sałatkowych, sosów, zup, pesto, deserów i kremów • Profesjonalny nóż idealny do siekania, mieszania i emulgowania w kilka sekund • Pojemność do 4,5 l, prosty uchwyt zaciskowy • Prędkość: 350 do 3500 obr / min • 10 prędkości, funkcja pulsacyjna, funkcja odwrotna • Wyświetlacz LED • Cichy silnik • Wszystkie demontowalne części można myć w zmywarce

For the production of meat and fish stuffing, tartars, mayonnaise, salad dressings, sauces, soups, pestos, desserts and creams! The professional knife is ideal for chopping, mixing and emulsifying in just a few seconds Product features: Processing quantity: up to 4.5 liters, simple clamping handle, Speed: 350 to 3500 rpm 10 speeds, Pulse function, Inverse function, with LED display Quiet motor, All removable parts are dishwasher safe. Ready to plug in: 230 V / 1100 W.

ROBOT 2W1 SZATKOWNICA I CUTTER-WILK



Model opatentowany

WSZECHSTRONNOŚĆ DZIAŁANIA

2w1 krajalnica do warzyw i kuter; 18/10, poliwęglan 2in1 vegetable slicer and food processor; 18/10, polycarbonate

Nr kat.	W	obr./m	PLN	EUR
DY-CL322	1100	320/720	15 400,10	-

Łączy funkcję Krajalnicy do warzyw DY-CL121 oraz Kutra elektrycznego DY-CL222
Combines the functions of the DY-CL121 Vegetable Slicer and DY-CL222 Electric Cutter



dostarczany ze standardowym nożem.



BLEND & MIX - AKCESORIA DO SZATKOWNICY



Tarcza do plastrów; stal nierdzewna
Slice disc; SS

Nr kat.	slcthmm	PLN	EUR	Nr kat.	slcthmm	PLN	EUR
DY-CL1005	0,5	615,96	-	DY-CL1070	7	615,96	-
DY-CL1015	1,5	615,96	-	DY-CL1080	8	615,96	-
DY-CL1025	2,5	615,96	-	DY-CL1090	9	615,96	-
DY-CL1030	3	615,96	-	DY-CL1110	11	615,96	-
DY-CL1040	4	615,96	-	DY-CL1120	12	615,96	-
DY-CL1050	5	615,96	-	DY-CL1130	13	615,96	-

Tarcza tarka; stal nierdzewna
Grater disc; SS

Nr kat.	slcthmm	PLN	EUR
DY-CL2002	2	451,46	-
DY-CL2003	3	451,46	-
DY-CL2005	5	451,46	-
DY-CL2009	9	451,46	-



Tarcza julienne; stal nierdzewna
Julienne disk; SS

Nr kat.	slcthmm	PLN	EUR
DY-CL3032	3 x 2	852,66	-
DY-CL3042	4 x 2	852,66	-
DY-CL3044	4 x 4	852,66	-
DY-CL3055	5 x 5	852,66	-
DY-CL3052	5 x 2	852,66	-
DY-CL3088	8 x 8	852,66	-

Zestaw tarcz „Pizza”; stal nierdzewna
„Pizza” discs set; SS

Nr kat.	PLN	EUR
DY-CL6000	1 503,04	-

zestaw zawiera tarcze: do plastrów 2,5 mm i 4 mm, tarka 7 mm
Set including: slice discs 2,4 mm and 4 mm, grater disc 7 mm



Zestaw tarcz „Buffet”; stal nierdzewna
„Buffet” discs set; SS

Nr kat.	PLN	EUR
DY-CL6001	2 048,89	-

Zestaw zawiera tarcze: do plastrów 1,5 mm, 3 mm i 5 mm, tarka 2 mm
Set including: slice discs 1,5 mm, 3 mm and 5 mm, grater disc 2 mm

Zestaw tarcz „Catering”; stal nierdzewna
„Catering” discs set; SS

Nr kat.	PLN	EUR
DY-CL6002	4 246,00	-

Zawiera : tarcza do plastrów 1,5, 3 i 5 mm, tarka 2 mm, julienne 4x4 i 8x8 mm i 1 zestaw do krojenia w kostkę 10x10 mm
Set including: slice discs 0,5mm, 2,5 mm, 5 mm and 11 mm, grater disc 2 mm and 5 mm, julienne 4x4 mm, cube 10x10

Stojak na tarcze; PP
Disc holder; PP

Nr kat.	PLN	EUR
DY-CL7000	81,78	-

Możliwy montaż na stole lub na ścianie
Suitable for wall mounting





Higiena: Demontowalne na części: stopa i dzwon wykonane w 100% ze stali nierdzewnej.

Komfort: Najlepsze profesjonalne miksery na rynku.

Wszechstronność: Akcesoria: różga, przystawka do puree, blender.

Hygiene: Detachable mixer tool, tube and bell 100% in stainless steel for easy cleaning.

Comfort: Lightness for easy use.

Versatility: Various accessories, whisk, ricer tool, Blender accessory.

1 - 8 L ZAPROJEKTOWANY DO PRZYGOTOWANIA MNIEJSZYCH PORCJI | 1 - 8 L ESPECIALLY DESIGNED FOR SMALL PREPARATIONS



DEMONTOWALNA CZĘŚĆ ROBOCZA | DETACHABLE EQUIPMENT

Dynamix



Regulacja prędkości



Mikser Dynamix Mini 160
Mixer Dynamix Mini 160

Nr kat.	Ø cm	W	obr./m	kg	PLN	EUR
DY-MX050	7	220	0 - 13.000	1	1 022,00	-

Regulowana ilość obrotów • Demontowalna część robocza
Variable speed included • Detachable foot



Mikser Dynamix Mini 190
Mixer Dynamix Mini 190

Nr kat.	Ø cm	W	obr./m	kg	PLN	EUR
DY-MX090	7	250	0 - 13.000	1,2	1 356,00	-

Regulowana ilość obrotów • Demontowalna część robocza
Variable speed included • Detachable foot



Mikser z przystawką blendującą
Mixer with blender attachment

Nr kat.	Ø cm	W	obr./m	kg	PLN	EUR
DY-MX100	7	220	0 - 13.000	1	1 472,46	-

Regulowana ilość obrotów • Demontowalna część robocza • Element rozdrabniający stal 18/10 wzmocniony powłoką tytanową • Działa na zasadzie miążdżenia • Może pełnić funkcję przecieraka

Variable speed easily switchable • Detachable foot • Titanium coated 18/10 steel bell • Operates by crushing • Can also be used as a food mill



Zestaw Dynamix
Dynamix set

Nr kat.	PLN	EUR
DY-MF052	1 472,00	-

Zestaw zawiera mikser MINI 160 + różga (18,5 cm)
The set of MINI 160 mixer + whisk (18,5 cm)



Dynamix



Dwie prędkości



Mikser TWO-SPEED 160
Mixer TWO-SPEED 160

Nr kat.	Ø cm	W	obr./m	kg	PLN	EUR
DY-MX055	7	220	1.8.000	1	1 022,00	-

Demontowalna część robocza
Detachable foot



Mikser TWO-SPEED 190
Mixer TWO-SPEED 190

Nr kat.	Ø cm	W	obr./m	kg	PLN	EUR
DY-MX095	7	250	1.8.000	1,2	1 356,00	-

Demontowalna część robocza
Detachable foot





OPERATING TIME: 25 MIN.

SWOBODA RUCHU W KUCHNI | FREEDOM IN THE MOVEMENT IN THE KITCHEN



Mikser bezprzewodowy NOMAD 161
Battery for wireless mixers

Nr kat.		Ø cm	l cm	W	obr./m	kg	PLN	EUR
DY-MX130	mikser	11	45	220	0 - 10.000	1,1	1 604,00	-
DY-AC585	akumulator						440,00	-
DY-AC590	ładowarka						546,00	-

Zapasy akumulator i ładowarka dla wydłużonego czasu pracy
Extra charger and battery for longer cordless work



Mikser bezprzewodowy NOMAD 190
Battery for wireless mixers

Nr kat.		Ø cm	W	obr./m	kg	PLN	EUR
DY-MX140	mikser	11	250	0 - 10.000	1,5	1 841,00	-
DY-AC585	akumulator					440,00	-
DY-AC590	ładowarka					546,00	-

Zapasy akumulator i ładowarka dla wydłużonego czasu pracy
Extra charger and battery for longer cordless work

AKCESORIA **DynamiX**



NÓŻ 2-OSTRZOWY /
2 BLADE KNIFE - zupy warzywne, puree warzywne, składniki mięsne, rybne



NÓŻ 4-OSTRZOWY / 4 BLADE KNIFE - zupy kremy, gancache, marmolady, ciasto do naleśników, sosy emulsyjne, vinaigrette, smoothies



DYSK UBIJAJĄCY / BEATER DISC - do ubijania śmietany, białek, szaków



DYSK EMULGUJĄCO - MUSUJĄCY / SKIMMER DISK - emulsje ziołowe, serowe, majonez, kremy cukiernicze



Różga;
Whisk attachment

Nr kat.	l cm	PLN	EUR
DY-AC516	18,5	464,00	-



Ramię przecierające
Foodmil attachment

Nr kat.	l cm	PLN	EUR
DY-AC560	16	759,00	-

Zestaw noży do mikserów Mini; 18/10, tytan
Dynamix blade pack

Nr kat.	PLN	EUR
DY-AC540	268,00	-

Puree
Puree



Nr kat.	l cm	PLN	EUR
DY-AC517	12,6	1 113,00	-



Stojak na miksery Mini
Dynamix support

Nr kat.	PLN	EUR
DY-SM030	148,00	-



Pojemnik do miksowania 1 L; PC
Mixing container

Nr kat.	cap ml	PLN	EUR
DY-AC510	1000	132,00	-

KUP ON-LINE



BLENDER TOOL

Blender / homogenizator

Blenduje, homogenizuje, emulguje, łączy, wygładza, mieli, miażdży, nadaje lepkości.

Działanie:

Blendowana potrawa jest zassana, rozdrabniana i miażdżona przez młynek młotowy, a następnie wyrzucana przy bardzo wysokich obrotach przez szczeliny w dzwonie.

Zalety:

Perfekcyjnie aksamitna, kremowa konsystencja, bez dodatku śmietanki / tłuszczu.
Bez grudek i włókien.
Pulweryzuje nawet ości ryb lub włókna takich warzyw jak por, seler naciowy
Eliminuje używanie przecieraka. Oszczędność czasu.

Partner of the

Gelato French Team

Idealne narzędzie do lodów i sorbetów. Efektywniejsze łączenie się składników, dające rezultat kremowej i jedwabiście lekkiej konsystencji. Eliminuje przesiewanie.

Blender tool / homogenizator

It blends, homogenizes, emulsifies, blends, smooths, crumbles, gives viscosity.

Action:

Blended dish is sucked in, crushed and crushed by a hammer mill, and then thrown at very high speed through the gaps in the bell.

Benefits:

Perfectly velvety, creamy consistency, without the addition of cream / fat.
No lumps and fibers.
It even pulverises fish bones or fibers of such vegetables as leek, celery
It eliminates the use of a ruber. Time saving.

Partner of the

Gelato French Team

The perfect tool for ice cream and sorbets. More effective mixing of ingredients, resulting in a creamy and silky light consistency. Eliminates sieving.

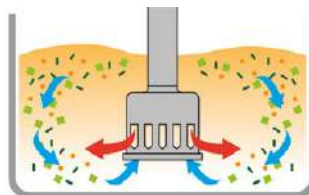

NAJLŹEJSZY MIKSER NA RYNKU W SWOJEJ KATEGORII | THE LIGHTEST MIXER ON THE MARKET IN ITS CATEGORY

Higiena: 100% demontowalny system: rozkręcana baza, ramię i dzwon.

Część robocza w 100% ze stali nierdzewnej

Komfort: Niewielki ciężar nie przeciąża ramion i barków.

Wszechstronny: Akcesoria: ramię miksera o różnej długości, różga, przystawka do puree, blender

Bezpieczeństwo: Podwójny włącznik - system zapobiegający przypadkowemu uruchomieniu

Hygiene: 100% detachable foot, tube and bell, 100% in stainless steel for easy cleaning.

Comfort: Lightness for easy use.

Versatility: Various accessories, whisk, Dynacutter bowl, ricer tool, Blender foot.

Safety: Unlocking safety feature.



Mikser Junior - monoblok
Mixer Junior - monoblock

Nr kat.	Ø cm	W	obr./m	kg	PLN	EUR
DY-MX020	9,4	270	11	1,7	1 756,00	-



Silnik Junior
Junior Engine

Nr kat.	Ø cm	l cm	W	obr./m	kg	PLN	EUR
DY-AC100	9,4	28	270	0 - 12.000	1,7	1 614,00	-

AKCESORIA JUNIOR

Zestaw Junior Combi
Junior Combi Set

Nr kat.	PLN	EUR
DY-MX022	3 380,00	-



Ramię blendujące
Blender attachment

Nr kat.	l cm	PLN	EUR
DY-AC101	22,5	597,00	-



Ramię blendujące XL
Blender XL attachment

Nr kat.	l cm	PLN	EUR
DY-AC105	30	779,00	-



Różga
Whisk attachment

Nr kat.	l cm	PLN	EUR
DY-AC102	18,5	1 169,00	-



Ramię przecierające
Foodmil attachment

Nr kat.	l cm	PLN	EUR
DY-AC066	22,5	910,00	-



Ramię do puree
Puree attachment

Nr kat.	l cm	PLN	EUR
DY-AC103	18,5	1 209,00	-



MASTER Regulacja prędkości

600 W / 9500-10500 OBR.

WSZECSTRONNOŚĆ NASZYCH URZĄDZEŃ JEST NIE DO POBICIA ! | OFFER UNRIVALLED VERSATILITY !

Higiena: Łatwo demontowalna stopa i dzwon. Stopa i dzwon w 100% ze stali nierdzewnej, łatwe do czyszczenia dzięki Clean up System.

Komfort: Łatwe użytkowanie dzięki małej wadze oraz łatwej regulacji prędkości.

Wszechstronność: Akcesoria: różga, kuter do miksera, różga, przystawka do puree, blender, różga XL.

Hygiene: Easily demountable foot and bell. Foot and bell in 100% stainless steel, easy to clean thanks to the Clean up System.

Comfort: Easy to use thanks to light weight and easy speed adjustment.

Versatility: Various accessories: whisk, Dynacutter bowl, ricer tool, Blender accessory, blender, whisk XL.

Clean Up System: KOMPLETNIEMO DEMONTOWALNA STOPA I DZWON MIKSERA

Łatwość czyszczenia, konserwacji i zachowania idealnej higieny.

Całość wykonana ze stali nierdzewnej dla zwiększenia wytrzymałości przystawki. Można myć w zmywarce.



Mikser Master - monoblok
Mixer Master - monoblock

Nr kat.	Ø cm	l cm	W	obr./m	kg	PLN	EUR
DY-MX005	11	71,5	600	10500	3,4	2 955,00	-



Mikser Master 500 - monoblok
Mixer Master 500 - monoblock

Nr kat.	Ø cm	l cm	W	obr./m	kg	PLN	EUR
DY-MX045	11	80	600	9500	3,6	3 284,00	-



Silnik Master
Master engine

Nr kat.	Ø cm	l cm	W	obr./m	kg	PLN	EUR
DY-AC001	12,2	35	500	3.000 - 9.500	3,4	2 332,00	-



Zestaw Master Combi
Master Combi set

Nr kat.	PLN	EUR
DY-MF002	4 822,00	-

AKCESORIA MASTER



Ramię blendujące
Blender attachment



Nr kat.	l cm	PLN	EUR
DY-AC002-H	41	1 087,00	-



Ramię blendujące XL
Blender XL attachment



Nr kat.	l cm	PLN	EUR
DY-AC500	50	1 154,00	-



Ramię przecierające
Foodmil attachment

Nr kat.	l cm	PLN	EUR
DY-AC070	40	1 796,00	-



Różga
Whisk attachment

Nr kat.	l cm	PLN	EUR
DY-AC003	24,5	1 401,00	-



Ramię do puree
Puree attachment

Nr kat.	l cm	PLN	EUR
DY-AC004	42	2 479,00	-



Różga XL
Whisk XL attachment

Nr kat.	l cm	PLN	EUR
DY-AC200	60	2 570,00	-



Kuter
Cutter

Nr kat.	cap l	PLN	EUR
DY-AC055	5	2 590,00	-



Uchwyt pomocniczy na garnek
Support for pot

Nr kat.	h cm	PLN	EUR
DY-SM020	13,5	84,46	-





925 W / 11000 OBR.

KUCHNIE PRZEMYSŁOWE I INTENSYWNE UŻYTKOWANIE | SPECIAL PRODUCTION KITCHENS AND INTENSIVE USE

Higiena: Demontowalne na części: stopa i dzwon, wykonane w 100% ze stali nierdzewnej.

Komfort: Najlepsze profesjonalne miksery na rynku.

Wszechstronność: Akcesoria: różga, przystawka do puree, blender

Hygiene: Detachable mixer tool, tube and bell 100% in stainless steel for easy cleaning.

Comfort: Lightness for easy use.

Versatility: Various accessories, whisk, ricer tool, Blender accessory.



Clean Up System: KOMPLETNIEMO DEMONTOWALNA STOPA I DZWON

Łatwość czyszczenia, konserwacji i zachowania idealnej higieny. Całość wykonana ze stali nierdzewnej dla zwiększenia wytrzymałości przystawki. Można myć w zmywarce. Ten wyjątkowy system DYNAMIC jest zgodny z wymaganiami HACCP.



Mikser SMX 700 Turbo
Mixer SMX 700 Turbo

Nr kat.	Ø cm	l cm	W	obr./m	kg	PLN	EUR
DY-MX040	12,5	87	925	11000	6,5	5 677,00	-



AKCESORIA SMX



Ramię przecierające
Foodmil attachment

Nr kat.	l cm	PLN	EUR
DY-AC072	43	2 479,00	-



Uchwyt pomocniczy na garnek
Support for pot

Nr kat.	h cm	PLN	EUR
DY-SM020	13,5	84,46	-



KRAJALNICA DYNACUBE



KRAJALNICA MANUALNA NR 1 NA ŚWIECIE | NR 1 MANUAL VEGETABLE CUTTERS IN THE WORLD

Higiena: Łatwa do czyszczenia.

Komfort: Łatwy transport i przechowywanie. Szybka instalacja, bezpieczeństwo pracy.

Wszechstronność: Narzędzia pozwalające na różne ciecia.

Hygiene: Easy to clean.

Comfort: Easy transport and storage. Quick instalation, safety work.

Versatility: Specific tools to allow different cuts.



Krajalnica Dyna Cube PC
Dyna Cube cutter; PC

Nr kat.	Ø cm	h cm	kg	PLN	EUR
DY-CL005	40	33	3,1	2 398,00	-



OSTRZA DYNACUBE



Ostrza do krajalnicy 17 mm; 18/10
Cutting blade 17 mm; 18/10

Nr kat.	PLN	EUR
DY-AC064	708,00	-



Ostrza do krajalnicy 14 mm; 18/10
Cutting blade 14 mm; 18/10

Nr kat.	PLN	EUR
DY-AC063	708,00	-



Ostrza do krajalnicy 10 mm; 18/10
Cutting blade 10 mm; 18/10

Nr kat.	PLN	EUR
DY-AC062	708,00	-



Ostrza do krajalnicy 8,5 mm; 18/10
Cutting blade 8,5 mm; 18/10

Nr kat.	PLN	EUR
DY-AC061	708,00	-



KUP ON-LINE





URZĄDZENIA ZASTĘPCZE



SERWIS



EKSPERTYZA



NAPRAWA W 48h



KITCHENAID - AMERYKAŃSKIE MIKSERY PLANETARNE | KITCHENAID - American planetary mixers

- Kultowe amerykańskie miksery planetarne
 - Istnieją na rynku od 1919 roku
 - Najbardziej niezawodne i najmocniejsze w swojej klasie
 - Jednorazowo przygotowuje ciasta na 7 półkilowych bochenków, 168 ciasteczek, ubije 19 białek czy 2 litry śmietany
 - Zaawansowany system kontroli pracy miksera zapewnia natychmiastową reakcję i dostarczanie optymalnej mocy do napędu narzędzi w dzieży
- *The iconic American planetary mixers*
 - *Mixers have been on the market since 1919*
 - *The most powerful and reliable in its class*
 - *It will prepare dough for 7 half-kilo loaves, 168 cookies, whips 19 whites or 2 liters of cream all in the same batch*
 - *The advanced mixer control system ensures an immediate response and delivery of optimal mixing power to tool drive in the bowl*



Mikser Kitchen Aid Professional 6,9 l

Nr kat.	col	W	kg	PLN	EUR
T-5KSM7990XEER	czerwony	500	13	7 443,49	-
T-5KSM7990XESM	szary	500	13	7 443,49	-
T-5KSM7990XEWH	biały	500	13	7 443,49	-

Wykonany całkowicie ze stali • Korpus - odlew cynkowy • Sprawna i cicha praca silnika • System napędu bezpośredniego • 10-stopniowa regulacja prędkości • Bogate wyposażenie standardowe (różga, hak spiralny, mieszadło płaskie, sztaplowalna dzieża 6,9l ze zdejmowanym podajnikiem) • Akcesoria wykonane w całości ze stali nierdzewnej



Różga stalowa do miksera 6,9 l Professional

Nr kat.	PLN	EUR
T-5K7EW	439,20	-



Hak spiralny do ciasta drożdżowego

Nr kat.	PLN	EUR
T-5K7SDH	684,72	-

Stal nierdzewna



Mieszadło płaskie do ciast i mas ucieranych

Nr kat.	PLN	EUR
T-5K7SFB	684,72	-

Stal nierdzewna



Dzieża sztaplowalna do miksera 6,9 l

Nr kat.	PLN	EUR
T-5K7SB	734,04	-



Mikser KitchenAid Heavy Duty 6,9 l

Nr kat.	col	W	kg	PLN	EUR
T-5KSM7591XEER	czerwony	500	13	6 379,65	-
T-5KSM7591XESM	szary	500	13	6 379,65	-
T-5KSM7591XEWH	biały	500	13	6 379,65	-

Osłona z podajnikiem wykonana z plastiku • Korpus - odlew cynkowy • 10-stopniowa regulacja prędkości • Bogate wyposażenie standardowe (różga, hak spiralny, mieszadło płaskie, sztaplowalna dzieża 6,9l ze zdejmowanym podajnikiem).



Sweet maker przystawka do draży

sprawdź przystawkę cukierniczą
- str. 157



Różga stalowa do miksera 6,9 l Professional

Nr kat.	PLN	EUR
T-5K7EW	439,20	-



Hak spiralny do ciasta drożdżowego

Nr kat.	PLN	EUR
T-5K7DH	243,00	-

Aluminium pokryte powłoką nylonową



Mieszadło płaskie do ciast i mas ucieranych

Nr kat.	PLN	EUR
T-5K7FB	439,20	-

Aluminium pokryte powłoką nylonową



Dzieża sztaplowalna do miksera 6,9l

Nr kat.	PLN	EUR
T-5K7SB	734,04	-



Różga - stal nierdzewna i aluminium

Nr kat.	PLN	EUR
T-K5AWW	324,69	-

Stal nierdzewna i aluminium • Nie można myć
w zmywarce.



Hak do ciasta drożdżowego

Nr kat.	PLN	EUR
T-K5ADH	324,69	-

Aluminium pokryte powłoką nylonową



Mieszadło płaskie do ciast i mas ucieranych

Nr kat.	PLN	EUR
T-K5AB	324,69	-

Aluminium pokryte powłoką
nylonową



Dzieża poj. 5l

Nr kat.	PLN	EUR
T-K5ASB	860,89	-

Stal nierdzewna



Osłona z podajnikiem do KitchenAid Heavy Duty 6,9 l

Nr kat.	PLN	EUR
T-5K7PS	324,69	-



Osłona z podajnikiem do KitchenAid Heavy Duty 5 l

Nr kat.	PLN	EUR
T-5KN1PS	439,20	-



IMPERIA - WŁOSKIE MAKARONIARKI | *IMPERIA - Italian pasta machine*

- Oryginalne, włoskie makaroniarki
- Produkowane od 1932 roku
- Dzięki wieloletniemu doświadczeniu marka Imperia stała się synonimem najwyższej jakości profesjonalnych urządzeń do makaronu
- *Original, Italian pasta machine*
- *Produced/manufactured since 1932*
- *Thanks to many years of experience, the Imperia brand has become synonymous with the highest quality of professional pasta equipment*

Makaroniarka elektryczna Imperia Restaurant; 18/10
Electric pasta machine Imperia Restaurant; 18/10

Nr kat.	l cm	h cm	w cm	W	kg	PLN	EUR
T-IM035	30	25	22	160	14,8	8 476,00	-

Szerokość ciasta 210 mm • Płynna regulacja grubości makaronu 0-5 mm • Cicha praca silnika • Prędkość rolek 45obrotów/minutę (12 kg makaronu na godzinę) • Bogaty asortyment akcesoriów • Akcesoria wykonane w całości ze stali nierdzewnej

Makaroniarka Imperia Restaurant; 18/10
Pasta machine Imperia Restaurant 18/10

Nr kat.	l cm	h cm	w cm	kg	PLN	EUR
T-IM010	32,5	27,5	22	9,3	2 906,00	-

Szerokość ciasta 210 mm • Płynna regulacja grubości makaronu 0-5 mm • Bogaty asortyment akcesoriów wykonanych w całości ze stali nierdzewnej

The pasta sheet width 210 mm • Pasta thickness adjusting every 0-5 mm • Wide range of stainless steel accessories

Makaroniarka Imperia I Pasta; 18/10
Pasta machine Imperia I Pasta; 18/10

Nr kat.	l cm	h cm	w cm	kg	PLN	EUR
T-IM100	16	20,5	18,5	3,4	447,00	-





Przystawka spaghetti; 18/10
Spaghetti attachment; 18/10

Nr kat.	Ø cm	PLN	EUR
T-IM097-N	0,2	708,00	-



Przystawka do nitek domowych; 18/10
Home made pasta attachment; 18/10

Nr kat.	w cm	PLN	EUR
T-IM070-N	0,2	708,00	-



Przystawka do tagliatelle; 18/10
Tagliatelle attachment; 18/10

Nr kat.	w cm	PLN	EUR
T-IM080-N	0,4	708,00	-



Przystawka do fettuccine; 18/10
Fettuccine attachment; 18/10

Nr kat.	w cm	PLN	EUR
T-IM090-N	0,65	708,00	-



Przystawka do pappardelle; 18/10
Pappardelle attachment; 18/10

Nr kat.	w cm	PLN	EUR
T-IM095-N	1,2	708,00	-



Przystawka do pappardelle; 18/10
Pappardelle attachment; 18/10

Nr kat.	w cm	PLN	EUR
T-IM098-N	1,2	708,00	-



Suszarka do makaronu 18/10
Pasta dryer; 18/10

Nr kat.	l cm	h cm	w cm	PLN	EUR
T-6133	45	45,5	45	191,43	-



Zestaw do ravioli; Al
Ravioli set; Al.

Nr kat.	PLN	EUR
T-IM317	205,00	-



Wycinarka do pierożków; 18/10
Dumplings cutter; 18/10

Nr kat.	l cm	w cm	PLN	EUR
T-9855	15,5	6,5	28,98	-



Wycinarka do pierogów; 18/10
Dumplin cutter; 18/10

Nr kat.	Ø cm	l cm	PLN	EUR
T-9655	6	15,5	28,98	-



FORMY SILIKONOWE

- innowacyjne materiały
- bogactwo kształtów



– perforacja R'System umożliwiająca lepszą cyrkulację powietrza



ELASTOMOULE®



Moul'flex^{Pro}



Moul'flex

Materiał:	Wysokiej jakości silikon z pyłem stalowym	Silikon platynowy	Silikon platynowy
R'System:	TAK (z wyjątkami)	TAK	NIE
Kolor:	szary	czarny	czarny
Zakres temperatur:	od -70°C do +300°C	od -40°C do +300°C	od -40°C do +280°C
Ocena jakości:	*****	***	**
Zastosowanie:	profesjonalne	profesjonalne	półprofesjonalne
Cechy:	Perfekcyjne rozprowadzanie temperatury dzięki mikro pęcherzykom powietrza w tworzywie silikonowym; przy pieczeniu składniki płynne ulegają karmelizacji, dzięki czemu uzyskujemy chrupiącą skórkę; szybsze schładzanie dzięki domieszce pyłu stalowego; idealne wykończenie form; łatwość wyjmowania upieczonego ciastka	Wytrzymały silikon dla intensywnego użycia; optymalna ilość form na matce; perforacja R'System umożliwia cyrkulację gorącego powietrza i perfekcyjne pieczenie na całej powierzchni; wieszak do maty w zestawie	Jakość standardowa

O czym należy pamiętać:

- Tylko przed pierwszym użyciem należy natłuścić matę odrobiną masła lub oleju (przy każdym następnym użyciu maty nie będzie to konieczne)
- Do pieczenia używaj rusztu, a nie blachy – najlepszy obieg powietrza
- Nigdy nie zostawiaj pustych foremek: jeśli nie masz wystarczającej ilości ciasta, posyp mąką, aby uniknąć uszkodzenia maty
- Myj formy gorącą wodą lub w zmywarce





– perforations which improve circulation of air



ELASTOMOULE®



Moul'flex^{Pro}



Moul'flex

Material:	High quality silicone foam material with metal powder	Platinum silicone	Platinum silicone
R'System:	YES (with exceptions)	YES	NO
Colour:	grey	black	black
Temperature range:	-70°C – 300°C	-40°C – 300°C	-40°C – 280°C
Quality assessment:	*****	***	**
Use/Applications:	professional	professional	semi-professional
Characteristics:	Perfect temperature distribution thanks to micro air bubbles in the silicone material; while baking, the liquid ingredients are caramelised, as a result crunchy crust is obtained; faster cooling thanks to the admixture of metal powder; perfect finishing of forms; a baked cookie can be removed with ease.	Heavy duty silicone for intensive use; the optimal number of forms on the tray; the R'System perforation enables the circulation of hot air and ensures perfect baking over the entire surface of the tray; tray hanger in the set.	Standard quality

Things to remember:

- Grease the mould with a little butter or oil before first use only (it is not necessary to grease the mould every time you use it)
- For best air circulation use a grate for baking, not a baking tray
- Never leave empty forms: if you do not have enough dough, sprinkle with flour to avoid damaging the mould
- Wash the mould with hot water or in a dishwasher



Silikonowa mata - cylindry
Silicone mould - cylinder

Nr kat.	wym. ciastek cm	l cm	w cm	PLN	EUR
D-1873-01	2,75 x 2,5	30	17,6	170,66	-



Forma silikonowa - bordelais
Silicone mould - bordelais

Nr kat.	wym. ciastek cm	l cm	w cm	PLN	EUR
D-1834-01D	5,5 x 5	30	17,6	170,66	-
D-1856-01D	3,5 x 3,5	30	17,6	170,66	-

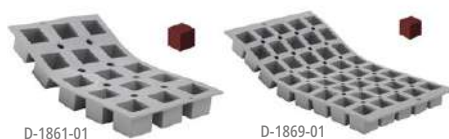

Forma silikonowa - sześciany
Silicone mould - cube

Nr kat.	wym. ciastek cm	l cm	w cm	PLN	EUR
D-1861-01	3,5 x 3,5 x 3,5	30	17,6	170,66	-
D-1869-01	2,5 x 2,5 x 2,5	30	17,6	170,66	-



Forma silikonowa - magdalenki
Silicone mould - madeleine

Nr kat.	wym. ciastek cm	l cm	w cm	PLN	EUR
D-1832-01D	8 x 4,5 x 1,7	30	20	170,66	-
D-1851-01D	4 x 3 x 1,1	30	20	170,66	-



Forma silikonowa - prostokąty
Silicone mould - cuboid

Nr kat.	wym. ciastek cm	l cm	w cm	PLN	EUR
D-1868-01	5 x 2,7 x 2,7	30	17,6	170,66	-



Silikonowa mata - płaska
Silicone mould - plain

Nr kat.	l cm	h cm	w cm	PLN	EUR
D-1800-55	55,5	1	36	417,24	-



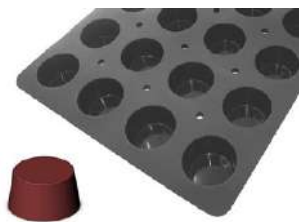

Moul'flex^{Pro}

Forma silikonowa - muffinki
Silicone mould - muffins

Nr kat.	wym. ciastek cm	l cm	w cm	PLN	EUR
D-1710-53	7x4	53	32,5	239,06	-
D-1710-60	7x4	60	40	307,46	-

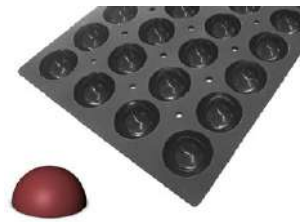

Moul'flex^{Pro}

Forma silikonowa - półkule
Silicone mould - half sphere

Nr kat.	wym. ciastek cm	l cm	w cm	PLN	EUR
D-1704-53	7x3,5	53	32,5	239,06	-
D-1704-60	7x3,5	60	40	307,46	-



Moul'flex

Forma silikonowa - sztabki
Silicone mould - bars

Nr kat.	wym. ciastek cm	l cm	w cm	PLN	EUR
D-1976-02	4,9x2,6x1,1	30	17,5	71,82	-



Moul'flex

Forma silikonowa - półkule
Silicone mould - half sphere

Nr kat.	wym. ciastek cm	l cm	w cm	PLN	EUR
D-1961-01	7x3,4	30	17,5	71,82	-
D-1961-02	4x2	30	17,5	71,82	-



Moul'flex

Forma silikonowa - muffinki
Silicone mould - muffins

Nr kat.	wym. ciastek cm	l cm	w cm	PLN	EUR
D-1962-01	7,2x3	30	17,5	71,82	-



Moul'flex

Forma silikonowa- babeczki
Silicone mould - bun

Nr kat.	wym. ciastek cm	l cm	w cm	PLN	EUR
D-1964-01	8x3,5	30	17,5	71,82	-



Moul'flex

Forma silikonowa - magdalenki
Forma silikonowa - madeleine

Nr kat.	wym. ciastek cm	l cm	w cm	PLN	EUR
D-1966-01	7,5x4,5	31	17,5	71,82	-





N

Forma silikonowa - Segreti del Bosco
Silicone mould - Segreti del Bosco

Nr kat.	wym. ciastek cm	cap ml	PLN	EUR
S-26-299-13-0065	6,5x5,5	115	71,76	-



N

Forma silikonowa - Delizia Al Limone
Silicone mould - Delizia Al Limone

Nr kat.	wym. ciastek cm	cap ml	PLN	EUR
S-26-261-13-0065	8,5x5,9x4,2	106	71,76	-



N

Forma silikonowa - Mini Eleganza
Silicone mould - Mini Eleganza

Nr kat.	wym. ciastek cm	cap ml	PLN	EUR
S-26-212-13-0065	7x7x3	100	71,76	-



N

Forma silikonowa - Cuoricino
Silicone mould - Cuoricino

Nr kat.	wym. ciastek cm	cap ml	PLN	EUR
S-26-186-13-0065	6,5x6,5x3,9	96	71,76	-



N

Forma silikonowa - Dolce Tartufo
Silicone mould - Dolce Tartufo

Nr kat.	wym. ciastek cm	cap ml	PLN	EUR
S-26-192-13-0065	6,2x5,2	120	83,90	-



N

Zestaw form - Kit Pop Eclair
Silicone mould - Kit Pop Eclair

Nr kat.	wym. ciastek cm	cap ml	PLN	EUR
S-25-275-13-0065	13x3,8x4,6	140	98,00	-

Zestaw zawiera dwie formy: podstawę wypieku oraz dekorację
The set includes two forms: baking base and decoration



N

Forma silikonowa - Coccola
Silicone mould - Coccola

Nr kat.	wym. ciastek cm	cap ml	PLN	EUR
S-26-305-13-0065	7x5,5	130	71,76	-



N

Forma silikonowa - Mini Intreccio
Silicone mould - Mini Intreccio

Nr kat.	wym. ciastek cm	cap ml	PLN	EUR
S-26-290-13-0065	7,5x3,5	105	71,76	-



N

Forma silikonowa - Mini Gemma
Silicone mould - Mini Gemma

Nr kat.	wym. ciastek cm	cap ml	PLN	EUR
S-26-246-13-0065	6,8x4,2	110	71,76	-





Forma silikonowa - Bollicine
Silicone mould - Bollicine

Nr kat.	wym. ciastek cm	cap ml	PLN	EUR
S-26-270-13-0065	7x3	85	71,76	-



Forma silikonowa - Mini Goccia
Silicone mould - Mini Goccia

Nr kat.	wym. ciastek cm	cap ml	PLN	EUR
S-26-234-13-0065	6,8x3,3	88	71,76	-



Forma silikonowa - Puff
Silicone mould - Puff

Nr kat.	wym. ciastek cm	cap ml	PLN	EUR
S-26-334-13-0065	6,2x5,2	125	71,76	-



Forma silikonowa - Mini Dress
Silicone mould - Mini Dress

Nr kat.	wym. ciastek cm	cap ml	PLN	EUR
S-26-377-13-0065	7x3	96	71,76	-



Forma silikonowa - Mini Raggio
Silicone mould - Mini Raggio

Nr kat.	wym. ciastek cm	cap ml	PLN	EUR
S-26-233-13-0065	6,7x3,3	85	71,76	-



Forma silikonowa - Raggio
Silicone mould - Raggio

Nr kat.	Ø cm	h cm	cap l	PLN	EUR
S-20-362-13-0065	19,5	6,8	1,5	98,00	-



Forma silikonowa - Honoré
Silicone mould - Honoré

Nr kat.	Ø cm	h cm	cap l	PLN	EUR
S-20-408-13-0065	19,5	7	1,6	98,00	-



Forma silikonowa - Wooly
Silicone mould - Wooly

Nr kat.	Ø cm	h cm	cap l	PLN	EUR
S-20-431-13-0065	19	7,2	1,46	102,00	-



Forma silikonowa - Quadro
Silicone mould - Quadro

Nr kat.	l cm	h cm	w cm	cap l	PLN	EUR
S-20-417-13-0065	21	3,5	21	1,4	98,00	-





N

Forma silikonowa - Gioia
Silicone mould - Gioia

Nr kat.	Ø cm	h cm	cap l	PLN	EUR
S-20-383-13-0065	21	7	1,66	98,00	-



N

Forma silikonowa - Bolle
Silicone mould - Bolle

Nr kat.	Ø cm	h cm	cap l	PLN	EUR
S-20-381-13-0065	22	5,5	1,6	98,00	-



N

Forma silikonowa - Buche Quenelle
Silicone mould - Buche Quenelle

Nr kat.	l cm	h cm	w cm	cap l	PLN	EUR
S-20-434-13-0065	24,3	7,7	9	1,3	102,00	-



N

Forma silikonowa - Buche Sapin
Silicone mould - Buche Sapin

Nr kat.	l cm	h cm	w cm	cap l	PLN	EUR
S-20-436-13-0065	25	8,7	8,9	1	124,00	-



N

Forma silikonowa - Goccia
Silicone mould - Goccia

Nr kat.	Ø cm	h cm	cap l	PLN	EUR
S-20-363-13-0065	22	7	1,6	98,00	-



N

Forma silikonowa - Batticuore
Silicone mould - Batticuore

Nr kat.	l cm	h cm	w cm	cap l	PLN	EUR
S-22-820-13-0065	20,5	3,9	19,8	1,5	98,00	-





N

Forma silikonowa - Perla 20
Silicone mould - Perla 20

Nr kat.	Ø cm	h cm	cap l	PLN	EUR
S-27-200-13-0065	20	4	1,25	98,00	-



N

Forma silikonowa - Perla 24
Silicone mould - Perla 24

Nr kat.	Ø cm	h cm	cap l	PLN	EUR
S-27-240-13-0065	24	4	1,8	98,00	-



N

Forma silikonowa - Dress
Silicone mould - Dress

Nr kat.	Ø cm	h cm	cap l	PLN	EUR
S-20-450-13-0065	18,5	4,7	1,2	98,00	-



N

Forma silikonowa - Intreccio
Silicone mould - Intreccio

Nr kat.	Ø cm	h cm	cap l	PLN	EUR
S-20-384-13-0065	21	7	1,6	98,00	-



N

Mata silikonowa do makaroników
Silicone mat for macaroni

Nr kat.	l cm	w cm	PLN	EUR
S-23-041-00-0065	40	30	47,00	-

48 zagłębień o średnicy 35 mm
48 recesses with a diameter of 35 mm





de Buyer

Mata silikonowa, perforowana
Silicone mat - perforated

Nr kat.	l cm	w cm	PLN	EUR
D-4938-40	40	30	61,22	-
D-4938-51	51	31	81,05	-
D-4938-58	58	38	94,73	-

Perforowana dla lepszej chrupkości produktu
Perforated for a better crunchiness of the product



de Buyer

Mata silikonowa - wzór makaroniki
Silicone mat - macaroon emblem

Nr kat.	l cm	w cm	PLN	EUR
D-4935-40	40	30	73,87	-
D-4935-60	60	40	97,81	-



de Buyer

Mata silikonowa
Silicone mat

Nr kat.	l cm	w cm	PLN	EUR
D-4931-51N	53	32,5	79,69	-
D-4931-58N	60	40	94,73	-

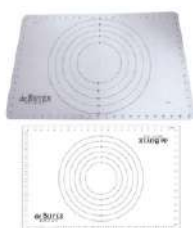

de Buyer

Mata silikonowa
Silicone mat

Nr kat.	l cm	w cm	PLN	EUR
D-4937-60	60	40	157,32	-

Na macie oznaczone koła 12, 16, 20, 24, 28, 32 cm
Matches marked 12, 16, 20, 24, 28, 32 cm on the mat



Walek do ciasta łożyskowy; buk
Rolling pin bearing; beech wood

Nr kat.	Ø cm	l cm	PLN	EUR
T-K30	9	60	140,00	-
T-K40	9	68	150,00	-



de Buyer

Walek do ciasta; buk
Rolling pin; beech wood

Nr kat.	Ø cm	l cm	PLN	EUR
D-4840-01N	5	50	58,14	-



Walek do ciasta; 18/10
Rolling pin; 18/10

Nr kat.	Ø cm	l cm	PLN	EUR
T-1717-490	6,5	49	138,23	-



Walek do ciasta; PE
Rolling pin; PE

Nr kat.	Ø cm	l cm	PLN	EUR
T-DP-43	4,3	43	108,68	-
T-DP50	4,8	50	119,23	-



de Buyer

Znacznik rozstawny dwustronny; 18/10
Pastry cutter

Nr kat.	PLN	EUR
D-4781-01	517,10	-

5 kółek tnących gładkich i 5 falistych • Stabilna konstrukcja • Zakres cięcia 1-11,5 cm • Śr. Kół tnących 5,5 cm
5 plain and 5 wavy cutting wheels • Stable construction



Wycinarka do ciasta; tworzywo
Cutter; plastic

Nr kat.	l cm	w cm	PLN	EUR
T-80041	12	11	18,03	-



Wycinarka do ciasta; tworzywo
Cutter; plastic

Nr kat.	l cm	w cm	PLN	EUR
T-80042	12	11	18,03	-



Wycinarka do ciasta; tworzywo
Cutter; plastic

Nr kat.	l cm	w cm	PLN	EUR
T-80043	21,5	6	13,23	-





de Buyer

Misa do miksowania; 18/10, silikon
Mixing bowl; 18/10, silicone

Nr kat.	Ø cm	h cm	cap l	PLN	EUR
D-3373-16	16	8,1	1	109,10	-
D-3373-20	20	10,2	2,1	145,35	-
D-3373-24	24	12,1	3,6	181,94	-
D-3373-30	30	14,8	7	224,35	-

Satynowe wykończenie • Nie ślizga się dzięki silikonowej podstawie • Podziałka wewnątrz

Satin finish • Does not slip thanks to the silicone base • Graduation inside



de Buyer

Misa cukiernicza; PP
Pastry bowl; PP

Nr kat.	Ø cm	h cm	cap l	PLN	EUR
D-4530-17	17	8	1	17,78	-
D-4530-23	23	10,5	2,5	23,26	-
D-4530-27	27	12	4,5	25,99	-
D-4530-32	32	15	6	37,62	-
D-4530-36	36	16	9	41,72	-
D-4530-40	40	18,5	13	60,88	-

Nadaje się do kuchenek mikrofalowych • Funkcjonalny otwarty rant • Sztaplowna

Suitable for microwave ovens • Functional open edge • Stackable



de Buyer

Misa do przetworów; miedź
Jam bowl; copper

Nr kat.	Ø cm	h cm	cap l	PLN	EUR
D-6200-38N	38	15	9	531,81	-

Żeliwne uchwyty • NIE wolno zapiekać w piekarniku

Cast iron handles • CAN'T be used in the oven



Misa do miksowania; 18/10
Mixing bowl; 18/10

Nr kat.	Ø cm	h cm	cap l	PLN	EUR
T-1954-36	36	29	25	801,36	-
T-1954-40	40	35,5	40	994,19	-

Satynowe wykończenie

Satin finish



Misa do miksowania; 18/10
Mixing bowl; 18/10

Nr kat.	Ø cm	h cm	cap l	PLN	EUR
T-50327	26	14	4	220,88	-
T-50333	32	18	9,5	283,86	-
T-50337	36	17,5	12	305,24	-

Satynowe wykończenie

Satin finish



de Buyer

Podstawa pod misę do miksowania; 18/10
Mixing bowl support; 18/10

Nr kat.	Ø cm	PLN	EUR
D-3379-00	10,8	60,53	-

D-3379-00 pasuje do mis o śr.: 20-24 cm

D-3379-00 fits the following mixing bowl diameters: 20-24 cm



de Buyer

Sweet maker- przystawka do draży; 18/10
Sweet maker - coating system; 18/10

Nr kat.	Ø cm	PLN	EUR
D-3500-00	40	2 769,86	-

Umożliwia pokrycie suszonych owoców cukrem, czekoladą, marcepanem itp.. • 6-8 kg cukierków można wytworzyć w 30 minut • Pasuje do mikserów Kitchen Aid

Allows to cover dried fruit with sugar, chocolate, marzipan, etc. • 6-8 kg of candy can be made in 30 minutes • Fits for Kitchen Aid mixers of confectionery in 30 minutes. The stainless steel double bell fits onto the entire Kitchenaid mixer range or with Dito Sama DMX5 and Dito Sama BE5-A beaters. Hygienic and easy to clean: dishwasher-safe.



Podgrzewacz do czekolady; 18/10
Chocolate heater; 18/10

Nr kat.	l cm	h cm	w cm	cap l	W	g	PLN	EUR
T-14-057	29	12	22	1	50	875	168,44	-

Zasilacz sieciowy

Power supply

KUP ON-LINE



de Buyer



Łopatka; 18/10, karbon
Spatula; 18/10, carbon

Nr kat.	l cm	w cm	PLN	EUR
D-4230-15	15	3,5	78,32	-
D-4230-30	30	3,5	109,10	-

de Buyer



Łopatka; 18/10, karbon
Spatula; 18/10, carbon

Nr kat.	l cm	w cm	PLN	EUR
D-4231-09	9	2,4	68,06	-
D-4231-15	15	3,5	78,66	-
D-4231-30	30	3,5	109,10	-

de Buyer



Nóż do biszkoptów; 18/10, karbon
Cake knife; 18/10, carbon

Nr kat.	l cm	w cm	PLN	EUR
D-4234-25	25	3,5	105,68	-
D-4234-35	35	3,5	112,52	-

Pozwala łatwo kroić biszkopt na warstwy - bez okruszków i nierówności

It allows you to easily cut sponge cake into layers - without crumbs or unevenness

de Buyer



Łopatka; 18/10, karbon
Spatula; 18/10, carbon

Nr kat.	l cm	w cm	PLN	EUR
D-4231-08	8	2	66,69	-



Szpatuła; 18/10
Spatula; 18/10

Nr kat.	l cm	w cm	PLN	EUR
T-26-630	31	3,4	104,74	-



T-26-825

Szpatuła; 18/10
Spatula; 18/10

Nr kat.	l cm	w cm	PLN	EUR
T-26-721	15	3,4	84,38	-
T-26-726	20	3,4	87,74	-
T-26-731	25	3,4	95,23	-
T-26-825	17	3,4	93,02	-

de Buyer



Sito; 18/10
Sieve; 18/10

Nr kat.	Ø cm	h cm	PLN	EUR
T-1080-200	20	6,2	57,67	-
T-1080-250	25	6,3	68,05	-
T-1080-300	30	7	87,19	-
T-1080-350	35	7,5	101,52	-

Gęsta siatka (8 otworów/cm²)

Dense grid (8 holes / cm²)



Sito; 18/10
Sieve; 18/10

Nr kat.	Ø cm	l cm	PLN	EUR
T-3190-12	12	28,5	25,07	-
T-3190-16	16	33,5	27,17	-
T-3190-20	20	39,5	40,51	-
T-3190-22	22	43,5	50,26	-

Gęsta siatka (6,5 otworów/cm²)

Dense net (6.5 holes / cm²)



Sito z wymiennymi siatkami; 18/10
Sieve with spare nets; 18/10

Nr kat.	Ø cm	h cm	PLN	EUR
D-4605-21	20	6	143,64	-

W zestawie 4 sita: 3 mm, 2 mm, 1mm, 0,5 mm.

4 sieves included: 3 mm, 2 mm, 1mm, 0,5 mm.



Sito chińskie; 18/10
Chinese strainer; 18/10

Nr kat.	Ø cm	l cm	PLN	EUR	
T-60321	20	40	139,37	-	
T-3318	stojak	18	28	85,68	-

Sito z siatką; stal cynowana, drewno
Soup strainer; tin, wood

Nr kat.	Ø cm	l cm	PLN	EUR
T-2635-30	30	78	114,24	-
T-2635-35	35	84	149,31	-

Podwójna siatka: zewnętrzna mocna i gęsta, wewnętrzna 6,5 otworów/cm² • Stalowy łuk podpierający

Double mesh: outer strong and dense, internal 6.5 holes / cm² • Steel arch support



Sitko - bardzo gęste; 18/10
Fine strainer; 18/10

Nr kat.	Ø cm	l cm	PLN	EUR
T-1210	7	21	20,10	-



TOMGAST



Pinceta kuchenna; 18/0
Tweezer; 18/0

Nr kat.	l cm	PLN	EUR
T-80035	21	17,55	-

TOMGAST



Pinceta kuchenna; 18/0
Tweezer; 18/0

Nr kat.	l cm	PLN	EUR
T-80036	30	25,92	-



Pinceta; 18/10
Tweezers; 18/10

Nr kat.	l cm	PLN	EUR
C1-P3407	14	37,41	-
C1-P3436	20	43,19	-
C1-P3443	powł. tytanowa	20	79,10



Różga; 18/10
Whisk; 18/10

Nr kat.	l cm	thk mm	wl	PLN	EUR
T-823-25	25	2,2	12	13,83	-
T-823-30	30	3,3	8	16,67	-
T-823-35	35	2,2	12	17,91	-
T-823-40	40	3,3	8	20,38	-
T-823-50	50	3,3	8	25,32	-
T-823-60	60	3,3	8	30,26	-



Różga; 18/10, silikon
Whisk; 18/10; silicone

Nr kat.	l cm	thk mm	wl	PLN	EUR
D-2610-20	22	1,4	8	58,75	-
D-2610-25	25	1,4	8	73,19	-
D-2610-35	35	1,8	8	91,12	-
D-2610-40	40	1,8	8	103,75	-
D-2610-45	46	1,8	8	116,11	-
D-2610-50	50	1,8	8	131,47	-

Ergonomiczny, silikonowy uchwyt
Ergonomic, silicone handle



Różga sprężysta; 18/10, silikon
Whisk; 18/10; silicone

Nr kat.	l cm	thk mm	wl	PLN	EUR
D-2611-35	35	2	8	100,32	-
D-2611-45	45	2	8	122,95	-

Ergonomiczny, silikonowy uchwyt
Ergonomic, silicone handle



Różga; włókno szklane, silikon
Whisk; 18/10; vinyl

Nr kat.	l cm	wl	PLN	EUR
T-61524	25	6	43,61	-

Druły powlekane silikonem
Silicone coated wires

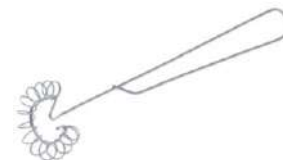

Trzepaczka spiralna; 18/10
Spiral whisk; 18/10

Nr kat.	l cm	PLN	EUR
T-900-250	29	24,23	-



Nóż cukierniczy
Pastry knife

Nr kat.	l cm	PLN	EUR
T-26-431	31	91,87	-



Nóż cukierniczy
Pastry knife

Nr kat.	l cm	PLN	EUR
T-26-631	31	105,31	-



Nóż cukierniczy
Pastry knife

Nr kat.	l cm	PLN	EUR
T-26-600	18	91,87	-

KUP ON-LINE





Szpatuła; poliglas Spatula; poliglass

Nr kat.	l cm	PLN	EUR	Nr kat.	l cm	PLN	EUR
D-4745-25	25	13,00	-	D-4745-40	40	25,31	-
D-4745-30	30	16,42	-	D-4745-45	45	32,83	-
D-4745-35	35	18,13	-	D-4745-50	50	38,99	-

Odporna na temp. do +220°C

Resistant to temperatures up to + 220 ° C



Szpatuła; silikon Spatula; silicone

Nr kat.	l cm	PLN	EUR
T-80025	25	55,08	-
T-80026	36	68,17	-
T-80027	40	70,03	-

Maksymalna temperatura pracy 260°C

Max operating temperature 260°C



Pędzelek silikonowy; silikon, 18/0 Silicone brush; silicone, 18/0

Nr kat.	l cm	PLN	EUR
T-80023	20	15,81	-
T-80024	24	19,51	-

Maksymalna temperatura pracy 260°C

Max operating temperature 260°C



Szpatuła; silikon, 18/0 Spatula; silicone, 18/0

Nr kat.	l cm	PLN	EUR
T-80028	28	28,90	-
T-80029	32,5	31,74	-

Maksymalna temperatura pracy 300°C

Max operating temperature 300°C



Szpachla do czekolady; 18/10 Chocolate spatula; 18/10

Nr kat.	l cm	w cm	PLN	EUR	
T-307-610	prosta	11,5	12	31,20	-
T-307-611	ukośna	11	12	32,06	-



Szpachelka; 18/10 Scraper; 18/10

Nr kat.	l cm	w cm	PLN	EUR
T-112-502	23	8	44,54	-
T-112-504	24	12	55,49	-



Skrobka; tworzywo Dough scraper; plastic

Nr kat.	l cm	w cm	PLN	EUR
T-22-365	11,2	7,8	4,09	-
T-22-355	12	8	3,80	-
T-22-231	13,7	8,6	4,66	-



Skrobka; tworzywo Dough scraper; plastic

Nr kat.	l cm	w cm	PLN	EUR
T-22-350	22,1	13	14,88	-



Skrobka; tworzywo Scraper; plastic

Nr kat.	l cm	w cm	PLN	EUR
T-22-352	12,8	9	3,80	-

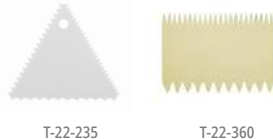

Skrobka; tworzywo Scraper; plastic

Nr kat.	l cm	w cm	PLN	EUR
T-22-235	10,5		4,09	-
T-22-360	11,6	7,8	3,52	-



Wybierak do ciasta; 18/10 Dough scraper; 18/10

Nr kat.	l cm	PLN	EUR
T-0075	12,5	20,66	-



de Buyer

Pędzelek silikonowy
Silicone brush



Nr kat.	l cm	w cm	PLN	EUR
D-4807-60N	25	4	51,64	-

Łatwe w utrzymaniu czystości
Easy to clean



de Buyer

Pędzelek silikonowy
Silicone brush

Nr kat.	l cm	w cm	PLN	EUR
D-4807-00	19	3	25,65	-
D-4807-50	25	6	37,28	-

Łatwe w utrzymaniu czystości
Easy to clean



Pędzelek; drewno, naturalne włosie
Brush; wood, natural bristle

Nr kat.	l cm	w cm	PLN	EUR
T-113-208	21	3	8,93	-
T-113-206	22	4	12,86	-
T-113-209	25	8	30,62	-

Wybielana, pozbawiona naftaliny szczecina • Odporny na działanie środków spożywczych
Bleached, naphthalene-free bristles • Resistant to food



T-53-900



T-53-908

Aerograf cukierniczy
Pastry airbrush

Nr kat.	cap ml	PLN	EUR
T-53-900 <i>MOC: 60W</i>	700	2 143,39	-
T-53-908 <i>pojemnik zapasowy</i>	700	220,51	-

Pistolet cukierniczy do natryskiwania produktów typu: masło, olej, wosk, galaretki, dżemy, czekolada i emulsje

Spray gun confectionery products of the type: butter, oil, wax, jelly, jam, chocolate, and emulsions



Dysza
Nozzle

Nr kat.	Ø cm	PLN	EUR
T-53-901	0,4	138,72	-
T-53-902	0,6	138,72	-
T-53-903	0,8	138,72	-



Dysza do czyszczenia pieców
Nozzle for cleaning furnace

Nr kat.	PLN	EUR
T-53-904	255,07	-



Końcówka do czyszczenia dysz
Cleaning attachment for nozzles

Nr kat.	PLN	EUR
T-53-905	298,46	-

KUP ON-LINE



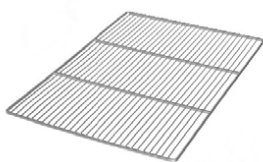

Ruszt 60x40; 18/10
Grate 60x40; 18/10

Nr kat.	l cm	w cm	PLN	EUR
D-3330-60	60	40	82,76	-



Ruszt z nóżkami; 18/10
Grate with feet; 18/10

Nr kat.	Ø cm	h cm	PLN	EUR
D-0237-28	28	2,5	54,72	-
D-0237-32	32	2,5	68,40	-



Ruszt GN; 18/10
Grate GN; 18/10

Nr kat.	l cm	w cm	PLN	EUR
T-R23001	35,4	32,5	66,03	-
T-R11001	53	32,5	65,55	-
T-R21001	65	53	130,70	-



Blacha do pieczenia; stal węglowa
Baking tray; carbon steel

Nr kat.	l cm	h cm	w cm	thk mm	PLN	EUR
D-5320-53	53	2	32,5	1,2	117,31	-
D-5362-60	60	2	40	1,2	152,87	-

Perfekcyjne przewodzenie ciepła • Solidna, nie ulega zniekształceniom
• Znakomicie nadaje się do pieczenia - powierzchnia blachy posiada mikroskopijne nierówności, które tworzą warstwę powietrza pomiędzy ciastem a blachą

Perfect heat conduction • Solid, no distortion • Perfect for baking - the surface of the sheet has microscopic unevenness that creates a layer of air between the dough and the baking tray



Blacha do pieczenia; stal węglowa
Baking tray; carbon steel

Nr kat.	l cm	h cm	w cm	thk mm	PLN	EUR
D-5321-53	53	1	32,5	1,2	68,06	-
D-5363-60	60	1	40	1,2	74,90	-

Perfekcyjne przewodzenie ciepła • Solidna, nie ulega zniekształceniom
• Znakomicie nadaje się do pieczenia - powierzchnia blachy posiada mikroskopijne nierówności, które tworzą warstwę powietrza pomiędzy ciastem a blachą

Perfect heat conduction • Solid, no distortion • Perfect for baking - the surface of the sheet has microscopic unevenness that creates a layer of air between the dough and the baking tray



Blacha GN 1/1; Al, non-stick
Sheet GN 1/1; Al, non-stick

Nr kat.	l cm	h cm	w cm	thk mm	PLN	EUR
D-8161-53	53	1	32,5	2	123,46	-
D-8161-60	60	1	40	2	162,79	-

Krawędzie rozszerzane ku górze • Wypiek nie przywiera do blachy • Łatwa w myciu

Edges expanding upwards • Baking does not adhere to the sheet • Easy to clean



Blacha do pieczenia perforowana non-stick; Al
Perforated baking tray; Al, non-stick

Nr kat.	l cm	h cm	w cm	thk mm	PLN	EUR
D-8162-53	53	0,5	32,5	2	239,74	-
D-8162-60	60	0,5	40	2	252,40	-

Perforowane dno pozwala uzyskać efekt chrupiącego kruchego spodu wypieku • Wypiek nie przywiera do blachy • Łatwa w myciu

Perforated bottom allows to obtain the effect of a crispy brittle bottom of baking • Baking does not stick to the sheet • Easy to clean



Blacha do pieczenia perforowana; Al
Perforated baking tray; Al

Nr kat.	l cm	h cm	w cm	thk mm	PLN	EUR
D-7367-53	53	1	32,5	1,5	145,35	-
D-7367-60	60	1	40	1,5	151,51	-

Perforowane dno pozwala uzyskać efekt chrupiącego kruchego spodu wypieku • Wypiek nie przywiera do blachy

Perforated bottom allows to obtain the effect of a crispy brittle bottom of baking
• Baking does not stick to the sheet



Blacha do pieczenia; Al
Baking tray; Al.

Nr kat.	l cm	w cm	thk mm	PLN	EUR
T-DAPLR20	60	40	2	116,40	-



Blacha do pieczenia; Al
Baking tray; Al.

Nr kat.	l cm	h cm	w cm	thk mm	PLN	EUR
T-DALR15	60	2	40	1,5	88,86	-



Blacha do bagietek perforowana; Al
Baguette baking tray; Al.

Nr kat.	l cm	w cm	thk mm	PLN	EUR
T-DB6040	60	40	2	228,18	-



Blacha do pieczenia perforowana; Al
Perforated baking tray; Al

Nr kat.	l cm	w cm	thk mm	PLN	EUR
D-7368-60	60	40	1,5	147,40	-



Blacha do pieczenia perforowana z powłoką silikonową; Al
Perforated baking tray; Al, silicone coated

Nr kat.	l cm	h cm	w cm	thk mm	PLN	EUR
T-38-052	53	1	32,5	1,5	140,03	-
T-38-102	60	1,5	40	1	172,81	-





Palnik do karmelizowania; Al.
Blowtorch

Nr kat.	h cm	PLN	EUR
T-3850	15	175,75	-

Działa pod dowolnym kątem • Czas działania na jednym napełnieniu: ok. 1 godz. • Podgrzewa do temp. 1450°C

Works at any angle • Operating time on one fill: approx. 1 hour • Heats up to 1450°C



Szpatuła z termometrem; silikon
Spatula with thermometer; silicone

Nr kat.	l cm	PLN	EUR
T-14039	29	64,60	-

Zakres temp. od -50°C do +300°C
Temp. from -50°C to +300°C



Minutnik
Timer

Nr kat.	l cm	h cm	w cm	PLN	EUR
D-4650-00N	8,1	6,2	3,6	64,30	-

Odliczanie od 20 min. • Mierzenie do 20 godz. • Z tyłu obudowy magnes

Countdown from 20 min. • Measuring up to 20 hours • magnet on the back of the housing



Papier rantowy woskowany
Rim paper

Nr kat.	l cm	h cm	PLN	EUR
T-10-007	400	7	172,52	-



Rękawice piekarnicze; tkanina frotte
Oven gloves frotte textile

Nr kat.	l cm	PLN	EUR
T-6543-30	30	41,09	-

Odporność na temperaturę do 250°C • Pranie w 60°C
Temperature resistant up to 250°C • Wash at 60°C



Rękawice piekarnicze; silikon
Oven gloves; silicone

Nr kat.	l cm	PLN	EUR
T-31-031	28,5	278,21	-

Odporność na temperaturę do 250°C, w czasie maksymalnie 15 s
• Można myć w zmywarce

Temperature resistant up to 250°C, no longer than 15 s
• Dishwasher safe



Forma do babek; stal, non-stick
Kougloff mould; steel, non-stick

Nr kat.	Ø cm	h cm	PLN	EUR
D-4701-22	22	10	89,26	-



Forma do babek; stal, non-stick
Brioche fluted mould; steel, non-stick

Nr kat.	Ø cm	h cm	PLN	EUR
D-4702-10	10	4,5	17,78	-
D-4702-22	22	8,3	37,62	-





BLACHY I FORMY

- wszechstronne zastosowania
- najwyższa jakość



Forma cukiernicza; stal, non-stick
Pastry mould; steel, non-stick

Nr kat.	l cm	h cm	w cm	PLN	EUR
D-4709-23	23	2,7	23	85,50	-



Forma cukiernicza; stal, non-stick
Pastry mould; steel, non-stick

Nr kat.	l cm	h cm	w cm	PLN	EUR
D-4708-36	35,6	2,7	10,2	63,27	-



Forma cukiernicza; stal, non-stick
Pastry mould; steel, non-stick

Nr kat.	Ø cm	h cm	PLN	EUR
D-4706-24	23	2,8	67,03	-
D-4706-28	28	3	86,53	-



Blacha do tart; stal węglowa
Tart mould; carbon steel

Nr kat.	Ø cm	PLN	EUR
D-5357-24	24	94,39	-

Stal węglowa osiąga wyższe temperatury niż stal z powłoką non-stick
Carbon steel reaches higher temperatures than non-stick steel



Tortownica; stal, non-stick
Pastry mould; steel, non-stick

Nr kat.	Ø cm	h cm	PLN	EUR
D-4844-20	20	6,7	53,01	-
D-4844-24	24	6,7	57,46	-
D-4844-26	26	6,7	60,19	-
D-4844-28	28	6,7	64,64	-



Forma cukiernicza; stal, non-stick
Pastry mould; steel, non-stick

Nr kat.	l cm	h cm	w cm	PLN	EUR
D-4715-15	15	4,8	7,5	30,10	-
D-4715-24	24	6,1	13	50,96	-
D-4715-26	26	6,3	10	62,59	-



Forma cukiernicza; stal, non-stick
Pastry mould; steel, non-stick

Nr kat.	l cm	h cm	w cm	PLN	EUR
D-4716-25	25	7	10,8	87,57	-
D-4716-30	30	7	10,8	101,92	-



Mou'flex

Forma cukiernicza; silikon
Pastry mould; silicone

Nr kat.	l cm	h cm	w cm	PLN	EUR
D-1984-24	24	6,5	10,5	95,42	-





Forma do terrin, ciast; 18/10
Terrine, cakes mold; 18/10

Nr kat.	Ø cm	l cm	h cm	PLN	EUR
D-3206-30	7,5	30	6,5	98,84	-



Zestaw arkuszy ze wzorem; tworzywo
Relief sheets for mould; plastic

Nr kat.	l cm	w cm	PLN	EUR
D-4343-00	30	18,5	58,48	-

Gietki arkusz z tworzywa sztucznego należy umieścić w formie na zwinięty placek lub w ramce na ciasto przed wypaleniem formy ciastem. Po zamrożeniu uzyskuje się oryginalną dekorację reliefową na cieście. • Dostępne są 4 wzory • Nie można piec w piekarniku • Pasuje do formy D-3206-30

The supple plastic sheet is to place in the mould for rolled-cake or in the pastry frame before making your cream cake. An original relief decoration on the cake is obtained after freezing. • 4 patterns are available • No oven cooking • Fits D-3206-30 mold



Forma do terrin, ciast; 18/10
Terrine, cakes mold; 18/10

Nr kat.	l cm	h cm	w cm	cap l	thk mm	PLN	EUR
T-882-261	26	7,5	8	0,7	0,9	129,68	-
T-882-262	26	7,5	8,5	1	0,9	129,68	-
T-883-300	30	7	8	1,2	0,9	166,25	-
T-885-501	50	9	10	2	0,9	299,25	-
T-885-502	50	9	10	3,5	0,9	270,75	-

Grubość stali 0,9 mm • Solidna, spawana konstrukcja
Steel thickness 0.9 mm • Robust, welded construction



Forma do pieczenia, do terrin, do ciast; 18/10
Terrin, cakes baking mold; 18/10

Nr kat.		l cm	h cm	w cm	PLN	EUR
D-3210-24	perforowana	24	6	5	341,66	-
D-3210-35	perforowana	35	7,5	7	444,26	-
D-3210-48	perforowana	48	8,5	9	512,66	-

Komfortowe formowanie i wyciąganie wypieku
Easy forming and removal



Forma do pieczenia; stal nierdzewna
Baking mould; stainless steel

Nr kat.		Ø cm	Ø o mm	h cm	PLN	EUR
D-3213-20	perforowana	20	2	7,5	225,94	-
D-3213-24	perforowana	24	2	7,5	238,46	-

Do użycia na ciepło i zimno • Perforacja o Ø 2 mm na całej powierzchni • Dostarczana z arkuszem do pieczenia • Zakres temperatury: -170 + 260°C

For hot and cold use • Ø 2 mm perforation on the whole surface • Supplied with baking sheet • Temperature ranges: -170 + 260°C



Forma do pieczenia; stal nierdzewna
Baking mould; stainless steel

Nr kat.		Ø o mm	l cm	h cm	w cm	PLN	EUR
D-3212-35	perforowana	2	35	3,5	10,5	202,69	-

Do użycia na ciepło i zimno • Perforacja o Ø 2 mm na całej powierzchni • Dostarczana z arkuszem do pieczenia • Zakres temperatury: -170 + 260°C

For hot and cold use • Ø 2 mm perforation on the whole surface • Supplied with baking sheet • Temperature ranges: -170 + 260°C



Forma do tarty; stal nierdzewna
Grate mould; stainless steel

Nr kat.		Ø cm	Ø o mm	h cm	PLN	EUR
D-3214-24	perforowana	24	2	2,5	225,95	-
D-3214-28	perforowana	28	2	2,5	221,24	-

Do użycia na ciepło i zimno • Perforacja o Ø 2 mm na całej powierzchni • Dostarczana z arkuszem do pieczenia • Zakres temperatury: -170 + 260°C

For hot and cold use • Ø 2 mm perforation on the whole surface • Supplied with baking sheet • Temperature ranges: -170 + 260°C



Forma do pieczenia; stal nierdzewna
Baking mould; stainless steel

Nr kat.		Ø o mm	l cm	h cm	w cm	PLN	EUR
D-3215-15	perforowana	2	15	7,5	8,6	188,22	-
D-3215-26	perforowana	2	26	7,5	8,6	225,97	-

Do użycia na ciepło i zimno • Perforacja o Ø 2 mm na całej powierzchni • Dostarczana z arkuszem do pieczenia • Zakres temperatury: -170 + 260°C

For hot and cold use • Ø 2 mm perforation on the whole surface • Supplied with baking sheet • Temperature ranges: -170 + 260°C



Arkusz do form; włókno szklane pokryte PTFE
Sheet for moulds; fiberglass coated with PTFE

Nr kat.	→ □	PLN	EUR
D-4344-60	D-3213-20	56,20	-
D-4344-61	D-3213-24	64,12	-

Włókno szklane z powłoką non-stick • Wielokrotnego użytku (do 200 razy) • Zakres temperatury: od -170° do +260°C • Grubość 0,13 mm

Fiberglass with non-stick coating • Reusable (up to 200 times) • Temperature range: from -170° to +260°C • Thickness 0.13 mm



Arkusz do form; włókno szklane pokryte PTFE
Sheet for moulds; fiberglass coated with PTFE

Nr kat.	→ □	PLN	EUR
D-4344-51	D-3212-35	64,12	-

Włókno szklane z powłoką non-stick • Wielokrotnego użytku (do 200 razy) • Zakres temperatury: od -170° do +260°C • Grubość 0,13 mm

Fiberglass with non-stick coating • Reusable (up to 200 times) • Temperature range: from -170° to +260°C • Thickness 0.13 mm



Arkusz do form; włókno szklane pokryte PTFE
Sheet for moulds; fiberglass coated with PTFE

Nr kat.	→ □	PLN	EUR
D-4344-71	D-3214-24	56,20	-
D-4344-72	D-3214-28	64,12	-

Włókno szklane z powłoką non-stick • Wielokrotnego użytku (do 200 razy) • Zakres temperatury: od -170° do +260°C • Grubość 0,13 mm

Fiberglass with non-stick coating • Reusable (up to 200 times) • Temperature range: from -170° to +260°C • Thickness 0.13 mm



Arkusz do form; włókno szklane pokryte PTFE
Sheet for moulds; fiberglass coated with PTFE

Nr kat.	→ □	PLN	EUR
D-4344-41	D-3215-15	56,20	-
D-4344-42	D-3215-26	64,12	-

Włókno szklane z powłoką non-stick • Wielokrotnego użytku (do 200 razy) • Zakres temperatury: od -170° do +260°C • Grubość 0,13 mm

Fiberglass with non-stick coating • Reusable (up to 200 times) • Temperature range: from -170° to +260°C • Thickness 0.13 mm



RANTY CUKIERNICZE

**Rant cukierniczy perforowany; 18/10**
Perforated pastry ring; 18/10

Nr kat.	Ø cm	h cm	PLN	EUR
D-3099-01	5,5	2	29,15	-
D-3099-02	6,5	2	29,75	-
D-3099-03	7,5	2	30,78	-
D-3099-00	8,5	2	32,83	-
D-3099-04	10,5	2	34,54	-
D-3099-05	12,5	2	35,91	-
D-3099-06	15,5	2	41,38	-
D-3099-07	18,5	2	42,75	-
D-3099-08	20,5	2	45,83	-
D-3099-09	24,5	2	50,62	-
D-3099-10	28,5	2	56,77	-

Drobna perforacja daje efekt jednolitego pieczenia i karmelizacji • Idealnie gładka powierzchnia pozwala na łatwe wyjęcie ciasta z rantu

Small perforation gives the effect of uniform baking and caramelisation. • Perfectly smooth surface makes it easy removing the cake from the mold

**Rant cukierniczy perforowany; 18/10**
Perforated pastry ring; 18/10

Nr kat.	l cm	h cm	w cm	PLN	EUR
D-3099-19	7	2	7	34,20	-
D-3099-20	8	2	8	36,59	-
D-3099-21	15	2	15	48,91	-
D-3099-22	20	2	20	53,01	-
D-3099-23	17,5	2	17,5	50,96	-
D-3099-30	12	2	4	38,30	-
D-3099-33	28	2	11	68,06	-

Drobna perforacja daje efekt jednolitego pieczenia i karmelizacji • Idealnie gładka powierzchnia pozwala na łatwe wyjęcie ciasta z rantu

Small perforation gives the effect of uniform baking and caramelisation. • Perfectly smooth surface makes it easy removing the cake from the mold

**Rant cukierniczy, perforowany; 18/10**
Pastry ring - perforated; 18/10

Nr kat.	l cm	h cm	w cm	PLN	EUR
D-3098-30	12	3,5	4	54,38	-

Drobna perforacja daje efekt jednolitego pieczenia i karmelizacji • Idealnie gładka powierzchnia pozwala na łatwe wyjęcie ciasta z rantu

Small perforation gives the effect of uniform baking and caramelisation. • Perfectly smooth surface makes it easy removing the cake from the mold

**Rant cukierniczy, perforowany; 18/10**
Pastry ring - perforated; 18/10

Nr kat.	l cm	h cm	w cm	PLN	EUR
D-3032-35	35	3	10	72,16	-

**Rant cukierniczy, perforowany; 18/10**
Pastry ring - perforated; 18/10

Nr kat.	Ø cm	h cm	PLN	EUR
D-3030-20	20	3	62,93	-
D-3030-24	24	3	66,69	-
D-3030-28	28	3	73,87	-

Drobna perforacja daje efekt jednolitego pieczenia i karmelizacji • Idealnie gładka powierzchnia pozwala na łatwe wyjęcie ciasta z rantu

Small perforation gives the effect of uniform baking and caramelisation. • Perfectly smooth surface makes it easy removing the cake from the mold

**Rant cukierniczy, perforowany; 18/10**
Pastry ring - perforated; 18/10

Nr kat.	l cm	h cm	w cm	PLN	EUR
D-3031-23	23	3	23	72,16	-

Drobna perforacja daje efekt jednolitego pieczenia i karmelizacji • Idealnie gładka powierzchnia pozwala na łatwe wyjęcie ciasta z rantu

Small perforation gives the effect of uniform baking and caramelisation. • Perfectly smooth surface makes it easy removing the cake from the mold



Rant cukierniczy perforowany; 18/10
Pusher; 18/10

Nr kat.	l cm	h cm	w cm	PLN	EUR
D-3099-40	14,5	2	3,5	44,12	-
D-3099-42	27	2	8	61,56	-
D-3099-43	30	2	11	71,14	-



Rant cukierniczy perforowany; 18/10
Perforated pastry ring; 18/10

Nr kat.	l cm	h cm	w cm	PLN	EUR
D-3099-70	12	2	5	47,54	-

Drobna perforacja daje efekt jednolitego pieczenia i karmelizacji • Idealnie gładka powierzchnia pozwala na łatwe wyjęcie ciasta z rantu

Small perforation gives the effect of uniform baking and caramelisation. • Perfectly smooth surface makes it easy removing the cake from the mold

de Buyer



Rant cukierniczy; 18/10
Pastry ring; 18/10

Nr kat.	w cm	PLN	EUR
D-3077-18	18	71,14	-

de Buyer



Rant cukierniczy; 18/10
Pastry ring; 18/10

Nr kat.	Ø cm	h cm	thk mm	PLN	EUR
D-3912-12	12	8	1	58,48	-
D-3912-16	16	10	1	73,19	-
D-3912-20	20	12	1	96,10	-
D-3912-24	24	14	1	118,33	-

de Buyer



Rant cukierniczy; 18/10
Pastry ring; 18/10

Nr kat.	Ø cm	h cm	thk mm	PLN	EUR
D-3989-06	6	6	1,5	19,19	-
D-3989-07	7	8	1,5	29,07	-
D-3989-08	8	6	1,5	25,66	-
D-3989-10	10	4,5	0,8	29,07	-
D-3940-12	12	6	0,8	37,62	-
D-3940-16	16	6	1	48,56	-
D-3940-20	20	6	1	55,40	-
D-3940-24	24	6	1	65,66	-
D-3940-26	26	6	1	66,01	-
D-3940-30	30	6	1,2	82,76	-

de Buyer



Rant cukierniczy; 18/10
Pastry ring; 18/10

Nr kat.	l cm	h cm	w cm	PLN	EUR
D-3906-08	8	4,5	8	54,72	-
D-3906-12	12	4,5	12	63,27	-
D-3906-16	16	4,5	16	70,11	-
D-3906-20	20	4,5	20	76,61	-
T-6866	6	4,5	6	28,26	-



Rant cukierniczy; 18/10
Pastry ring; 18/10

Nr kat.	l cm	h cm	w cm	PLN	EUR
D-3929	39	5	29	71,78	-
D-5939	59	5	39	91,18	-



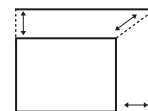
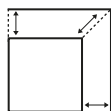

Rant cukierniczy, regulowany, kwadratowy; 18/10
Expandable pastry ring, square; 18/10

Nr kat.	l cm	h cm	w cm	PLN	EUR
D-3013-16	16-30	5	16-30	119,36	-
D-3013-20	20-37	5	20-37	143,30	-
D-3013-30	30-57	5	30-57	201,44	-

Rant cukierniczy, regulowany, prostokątny; 18/10
Expandable pastry ring, rectangular; 18/10

Nr kat.	l cm	h cm	w cm	PLN	EUR
D-3013-21	21,5-40	7,5	11,5-21	153,56	-
D-3013-43	43-84	5	29-56	280,10	-

Rant cukierniczy, regulowany; 18/10
Adjustable pastry ring; 18/10

Nr kat.	Ø cm	h cm	PLN	EUR
D-3040-03	18-36	3	95,76	-
D-3040-01	18-36	4,5	101,23	-



Dociskacz do rantu; 18/10
Pusher for ring; 18/10

Nr kat.	Ø cm	PLN	EUR
T-6908	8	14,39	-
T-6910	10	17,58	-
T-6956	6	11,09	-

Dociskacz; 18/10
Pusher; 18/10

Nr kat.	Ø cm	h cm	PLN	EUR
D-3006-01	7,4	6,1	33,86	-

D-3006-01 pasuje do D-3989-08 • D-3006-02 pasuje do D-3906-08
D-3006-01 fits D-3989-08 • D-3006-02 fits D-3906-08



Wycinarka; poliamid, włókno szklane
Cutter; polyamide, fiberglass

Nr kat.	Ø cm	PLN	EUR
D-4308-00	2-10	112,18	-

Zestaw 9 sztuk
Set includes 9 pcs



Wycinarka; poliamid, włókno szklane
Cutter; polyamide, fiberglass

Nr kat.	Ø cm	PLN	EUR
D-4307-00	2-10	112,18	-

Zestaw 9 sztuk
Set includes 9 pcs



Wycinarka; 18/10
Cutter; 18/10

Nr kat.	Ø cm	PLN	EUR
T-618-014	2,2-11,3	76,95	-

Zestaw 14 sztuk
Set includes 14 pcs



Wycinarka falista; 18/10
Corrugated Cutter; 18/10

Nr kat.	Ø cm	PLN	EUR
T-617-014	2-10,5	77,56	-

Zestaw 14 sztuk
Set includes 14 pcs

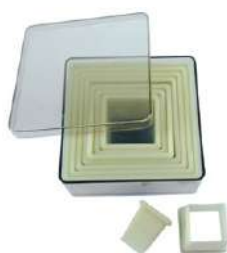

Wycinarka; poliamid, włókno szklane
Cutter; polyamide, fiberglass

Nr kat.	w cm	PLN	EUR
D-4304-30	2,8-9,8	111,49	-

Zestaw 9 sztuk
Set includes 9 pcs



LE TUBE



- | napełnianie, dekorowanie, dozowanie
- | idealny do kremów, gęstych musów, ciast parzonych
- | przezroczysty pojemnik z podziałką
- | 2 końcówki (gładka i gwiazdka)
- | system strzykawkowy dostosowuje się do zawartości
- | zestaw do ciastek kruchych



Pistolet do kremu / ciasta Le Tube; tworzywo
Pressure pastry syringe for dosing of pastes, creams; plastic

Nr kat.	cap ml	PLN	EUR
D-3358-01	750	324,56	-

Zawiera 2 końcówki z poliwęglanu oraz zestaw do ciastek D-3358-94
Contains 2 polycarbonate tips and a set for cakes D-3358-94



Zestaw do ciastek le Tube
Cookies set le Tube

Nr kat.	l cm	w cm	cap ml	PLN	EUR
D-3358-94	38,4	10,5	750	78,32	-

Zestaw zawiera 13 dysków do dekorowania oraz specjalne pokrywy zabezpieczające końcówkę dozownika.

13 tips for decoration and 2 lids



N

Zestaw końcówek cukierniczych I
12 szt.; tritan
Set of confectionery tips I 12 pcs; tritanium

Nr kat.	l cm	h cm	w cm	PLN	EUR
D-4150-04	21	7	12,5	124,28	-

Nie zawierają BPA • Materiał: tritan • Wzmocnione zęby
• Zestaw zawiera 3 końcówki okrągłe śr. 6, 11 oraz 13 mm; 5 końcówek w kształcie gwiazdy; 1 szt. końcówki Saint honore; 1 szt. końcówki wstążki, 1 szt. końcówki ptasie gniazdo oraz końcówkę imitującą liście • Pasują do pistoletu Le Tube • Możliwość wpięcia w uchwyt i zawieszania

BPA free • Material: tritan • Reinforced teeth • Set includes 3 round tips diameter. 6, 11 and 13 mm; 5 star-shaped tips; 1 piece of Saint honore tip; 1 pc. ribbon tip, 1 pc. bird nest tip and imitation leaf tip • Fits Le Tube gun • Can be hung



N

Zestaw końcówek cukierniczych II
12 szt.; tritan
Set of confectionery tips II 12 pcs; tritanium

Nr kat.	l cm	h cm	w cm	PLN	EUR
D-4150-09	21	7	12,5	124,28	-

Nie zawierają BPA • Materiał: tritan • Wzmocnione zęby • Zestaw zawiera 4 końcówki okrągłe o śr. 6, 8, 11 oraz 15 mm; 4 końcówki w kształcie gwiazdy; 2 szt. końcówki Saint honore; 1 szt. końcówki wstążki, 1 szt. końcówki imitującą liście • Pasują do pistoletu Le Tube • Możliwość wpięcia w uchwyt i zawieszania

BPA-free • Material: tritan • Reinforced teeth • Set includes 4 round tips with diameter. 6, 8, 11 and 15 mm; 4 star shaped tips; 2 pcs. Saint honore tips; 1 pc. ribbon tip, 1 pc. leaf tip • Fits Le Tube gun • Can be attached to the handle and hung



Pojemnik Le Tube
Container for Le Tube

Nr kat.	cap ml	PLN	EUR
D-3358-75	750	51,30	-

WORKI I KOŃCÓWKI CUKIERNICZE

- odporne na wysokie i niskie temperatury
- kompleksowe wyposażenie



Pistolet do sosów i kremów; 18/10
Automatic dispenser; 18/10

Nr kat.	cap l	PLN	EUR
T-1033-05	1,5	174,88	-

w zestawie dwie końcówki i stojak
included two nozzles and stand



Pistolet do sosów i kremów; 18/10
Automatic dispenser; 18/10

Nr kat.	Ø cm	h cm	cap l	PLN	EUR
D-3354-12	17,5	16,5	1,5	591,32	-
D-3354-52	20	38	3,3	680,58	-

Idealny do dekorowania sosami, napełniania form itp.
Perfect for decorating sauces, filling molds, etc.



de Buyer

Pistolet do sosów i kremów; 18/10
Automatic dispenser; 18/10

Nr kat.	Ø cm	h cm	cap l	PLN	EUR
D-3353-00	15	15,5	0,8	204,86	-

Idealny do dekorowania sosami, napełniania form itp.
Perfect for decorating sauces, filling molds, etc.



de Buyer

Worek cukierniczy; poliuretan
Pastry bag; polyurethane

Nr kat.	l cm	w cm	PLN	EUR
D-4347-35	35	20	71,48	-

Wewnątrz śliski dla łatwiejszego wyciskania • Do temperatury maks. 60°C
Inside slippery for easier squeezing • Up to a temperature of 60 ° C



de Buyer

Worki cukiernicze jednorazowe; PE
One use pastry bag; PE

Nr kat.	l cm	cap l	PLN	EUR
D-4348-40	40	0,5	92,68	-
D-4348-50	50	1,25	107,05	-

Rolka zawiera 100 worków • Do temperatury maks. 70°C
The roll contains 100 bags • Up to 70 ° C



de Buyer

Worek cukierniczy; bawełna
Pastry bag; cotton

Nr kat.	l cm	PLN	EUR
D-4856-25N	25	22,57	-
D-4856-30N	30	24,97	-
D-4856-35N	35	26,49	-
D-4856-40N	40	29,07	-
D-4856-45N	45	33,17	-
D-4856-50N	50	35,23	-
D-4856-60N	60	45,83	-

Wielokrotnego użytku • Specjalna powlekana bawełna • Bardzo giętkie
Reusable • Special coated cotton • Very flexible



Wieszak na worki i końcówki; 18/10
Wall rack for pastry bags and nozzles; 18/10

Nr kat.	l cm	w cm	PLN	EUR
T-53-001	50	50	163,02	-

Bardzo stabilna konstrukcja • 4 haki na worki do wyciskania, 31 haczyków na końcówki, półka i 5 haczyków zwisających
Very stable construction • 4 hooks for squeezing bags, 31 hooks for tips, shelf and 5 hanging hooks

Stojak do worków; PP
Holder for pastry bag; PP

Nr kat.	h cm	w cm	PLN	EUR
T-83-002	19,5	23	45,12	-

Stojak posiada 4 otwory na duże i 4 na małe końcówki
The stand has 4 holes for large and 4 for small tips



WORKI I KOŃCÓWKI CUKIERNICZE



Końcówka cukiernicza; 18/10
Pastry nozzle; 18/10

Nr kat.	Ø cm	PLN	EUR
D-2112-02N	0,3	11,90	-
D-2112-06N	0,5	10,77	-
D-2112-10N	0,7	10,77	-
D-2112-14N	1,1	11,90	-
D-2112-18N	1,3	10,77	-
D-2112-22N	1,8	10,77	-



Końcówka cukiernicza; 18/10
Pastry nozzle; 18/10

Nr kat.	Ø cm	PLN	EUR
D-2112-04N	0,35	11,90	-
D-2112-08N	0,6	10,77	-
D-2112-12N	0,7	10,77	-
D-2112-16N	1,1	10,77	-
D-2112-20N	1,3	10,77	-
D-2112-24N	1,8	10,77	-



Końcówka cukiernicza; 18/10
Pastry nozzle; 18/10

Nr kat.	Ø cm	PLN	EUR
D-2111-02N	0,2	10,77	-
D-2111-03N	0,3	10,77	-
D-2111-04N	0,4	10,77	-
D-2111-05N	0,5	10,77	-
D-2111-06N	0,6	10,77	-
D-2111-07N	0,7	11,90	-
D-2111-08N	0,8	10,77	-
D-2111-09N	0,9	11,90	-
D-2111-10N	1	10,77	-
D-2111-11N	1,1	10,77	-
D-2111-12N	1,2	10,77	-
D-2111-13N	1,3	10,77	-
D-2111-14N	1,4	10,77	-
D-2111-15N	1,5	10,77	-
D-2111-16N	1,6	11,90	-
D-2111-17N	1,7	11,90	-
D-2111-18N	1,8	10,77	-
D-2111-20N	2	11,90	-
D-2111-22N	2,2	11,90	-
D-2111-24N	2,4	10,77	-



Końcówka cukiernicza; 18/10
Pastry nozzle; 18/10

Nr kat.	Ø cm	PLN	EUR
D-2112-03N	0,3	11,90	-
D-2112-07N	0,5	10,77	-
D-2112-11N	0,7	10,77	-
D-2112-15N	1,1	10,77	-
D-2112-19N	1,3	10,77	-
D-2112-23N	1,8	10,77	-



Końcówka cukiernicza; 18/10
Pastry nozzle; 18/10

Nr kat.	Ø cm	PLN	EUR
D-2112-05N	0,5	11,90	-
D-2112-09N	0,7	10,77	-
D-2112-13N	0,9	10,77	-
D-2112-17N	1,1	10,77	-
D-2112-21N	1,3	10,77	-
D-2112-25N	1,8	10,77	-



Końcówka cukiernicza; 18/10
Pastry nozzle; 18/10

Nr kat.	PLN	EUR
D-2113-06N	10,77	-
D-2113-08N	10,77	-



Końcówka cukiernicza; 18/10
Pastry nozzle; 18/10

Nr kat.	w cm	PLN	EUR
D-2117-10	1	12,62	-
D-2117-15	1,5	12,93	-
D-2117-20	2	12,93	-
D-2117-30	3	12,93	-



Końcówka cukiernicza; 18/10
Pastry nozzle; 18/10

Nr kat.	Ø cm	PLN	EUR
D-2129-08N	0,8	11,97	-
D-2129-09N	0,9	10,77	-
D-2129-11N	1,1	10,77	-
D-2129-14N	1,4	10,77	-
D-2129-16N	1,6	10,77	-



Końcówka cukiernicza; 18/10
Pastry nozzle; 18/10

Nr kat.	PLN	EUR
D-2119-13	8 otworów	10,77



Końcówka cukiernicza; 18/10
Pastry nozzle; 18/10

Nr kat.	Ø cm	PLN	EUR
D-2118-03	12 otworów	0,7	10,77



WORKI I KOŃCÓWKI CUKIERNICZE



de Buyer

Końcówka cukiernicza; 18/10
Pastry nozzle; 18/10

Nr kat.	Ø cm	PLN	EUR
D-2116-07	0,7	10,77	-
D-2116-08	0,8	10,77	-
D-2116-10	1	10,77	-
D-2116-14	1,4	10,77	-
D-2116-16	1,6	10,77	-
D-2116-17	1,7	10,77	-



de Buyer

Końcówka cukiernicza; 18/10
Pastry nozzle; 18/10

Nr kat.	Ø cm	PLN	EUR
D-2120-01 wzór 241	2,67	10,77	-
D-2120-02 wzór 242	2,67	10,77	-



de Buyer

Końcówka cukiernicza; 18/10
Pastry nozzle; 18/10

Nr kat.	Ø cm	PLN	EUR
D-2120-03 wzór 243	2,67	10,77	-
D-2120-04 wzór 244	2,67	10,77	-



de Buyer

Końcówka cukiernicza; 18/10
Pastry nozzle; 18/10

Nr kat.	Ø cm	PLN	EUR
D-2120-05 wzór 246	2,67	10,77	-
D-2120-06 wzór 247	2,67	10,77	-



de Buyer

Końcówka cukiernicza; 18/10
Pastry nozzle; 18/10

Nr kat.	Ø cm	PLN	EUR
D-2120-07 wzór 257	2,67	10,77	-
D-2120-08 wzór 248	2,67	10,77	-



de Buyer

Końcówka cukiernicza; 18/10
Pastry nozzle; 18/10

Nr kat.	PLN	EUR
D-2126-00N 7 otw. śr. 1,3 mm	10,77	-
D-2126-01 9 otw. śr. 3 mm	10,77	-
D-2126-02 3 otw. ząbkowane	10,77	-



de Buyer

Końcówka cukiernicza; 18/10
Pastry nozzle; 18/10

Nr kat.	Ø cm	PLN	EUR
D-2120-20 drobne smugi, śr. 2,5	2,67	16,93	-
D-2120-21 duże smugi, śr. 2,5	2,67	16,93	-



de Buyer

Końcówka cukiernicza; 18/10
Pastry nozzle; 18/10

Nr kat.	dia cm	PLN	EUR
D-2115-25N	1,1	10,77	-
D-2115-35N	1,5	10,77	-



de Buyer

Zestaw 3 końcówek do nadziewania; 18/10
Garnish nozzles set 3 pcs; 18/10

Nr kat.	Ø mm	PLN	EUR
D-2125-03	4-6-8	58,14	-



TOMGAST

Zestaw końcówek cukierniczych
29 szt.; 18/10
Decorating tubes 29 pcs.; 18/10

Nr kat.	PLN	EUR
T-80030	81,26	-



TOMGAST

Zestaw końcówek cukierniczych
56 szt.; 18/10
Decorating tubes 56 pcs.; 18/10

Nr kat.	PLN	EUR
T-80031	146,72	-



Szczotka do końcówek; nylon, PP
Brush for nozzles; nylon, PP

Nr kat.	l cm	PLN	EUR
T-61-245	1,8	27,36	-

KUP ON-LINE





Patera; polipropylen, poliwęglan
Plateau; polypropylene, polycarbonate

Nr kat.	Ø cm	h cm	col	PLN	EUR
○ BP-AZ1-000	30	24	krystaliczny biały	161,79	-
● BP-AZ1-010	30	24	karbon	161,79	-
● BP-AZ1-314	30	24	leśny średni	161,79	-
● BP-AZ1-319	30	24	mokka	161,79	-
● BP-AZ1-335	30	24	morela	161,79	-
● BP-AZ1-336	30	24	cukier trzcinowy	161,79	-

zawiera pokrywę i łopatkę
includes lid and spatula



Blim

N



Blim

N

Pokrywa do patery; poliwęglan
Cover for the plate; polycarbonate

Nr kat.	Ø cm	h cm	col	PLN	EUR
BP-CT2-001	30	12	transparentny	80,49	-



Talerz płaski; melamina
Flat plate; melamine

Nr kat.	Ø cm	col	PLN	EUR
V-63300	33	biały	87,31	-

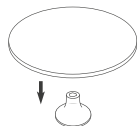

Podstawa; melamina
Base; melamine

Nr kat.	Ø cm	h cm	col	PLN	EUR
V-61301	15	9,5	biały	22,52	-

Pasuje do V-63300
Fits V-63300

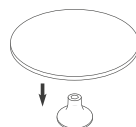

Patera; melamina
Plateau; melamine

Nr kat.	Ø cm	h cm	PLN	EUR
T-72-029	24	3	83,52	-
T-72-025	30	3	85,25	-



N

Patera
Plateau

Nr kat.	Ø cm	h cm	PLN	EUR
V-84004-1	30	10,5	119,00	-



Patera; melamina
Plateau; melamine

Nr kat.	Ø cm	col	PLN	EUR
T-27-028	32	biały	137,28	-
T-27-128	32	czarny	137,28	-



Patera; łupek
Plateau; slate

Nr kat.	Ø cm	h cm	PLN	EUR
TF-089	20/25	24	75,05	-

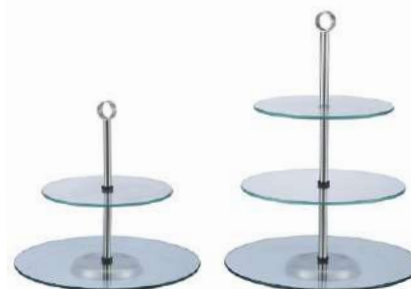

Patera; 18/10, szkło hartowane
Plateau; 18/10, tempered glass

Nr kat.	Ø cm	h cm	PLN	EUR
T-17504	30	28	71,38	-
T-17507	25	40	91,27	-





Blacha cukiernicza; 18/10
Baking tray; 18/10

Nr kat.	l cm	h cm	w cm	thk mm	PLN	EUR
D-3360-60	60	2	40	1	299,59	-

Wysokopolerowana • Idealna także do ekspozycji wypieków
Mirror polish • you can use as cake display



Blacha cukiernicza; 18/10
Baking tray; 18/10

Nr kat.	l cm	h cm	w cm	thk mm	PLN	EUR
D-3361-60	60	1	40	1	149,11	-

Wysokopolerowana • Idealna także do ekspozycji wypieków
Mirror polish • you can use as cake display



Blacha cukiernicza - 3 ranty; Al
Baking tray - 3 edges; Al

Nr kat.	l cm	h cm	w cm	PLN	EUR
T-TASR360	60	2	40	99,44	-



Blacha cukiernicza; Al
Baking tray; Al

Nr kat.	l cm	h cm	w cm	PLN	EUR
T-TAS40	40	2	25	43,60	-
T-TAS48	48	2	32	49,60	-
T-TAS60	60	2	40	59,88	-



Blacha cukiernicza; Al
Baking tray; Al

Nr kat.	l cm	h cm	w cm	PLN	EUR
T-TACH40	40	2	25	56,84	-
T-TACH48	48	2	32	72,80	-
T-TACH60	60	2	40	95,61	-



Taca; 18/10
Tray; 18/10

Nr kat.	l cm	h cm	w cm	PLN	EUR
T-4060-019	25	2,5	19	41,00	-
T-4060-022	28	2,5	22	49,65	-
T-4060-024	31	2,5	24	53,97	-
T-4060-026	34	2,5	26	69,16	-
T-4060-028	40	2,5	28	82,13	-
T-4060-032	46	2,5	32	112,26	-
T-4060-037	55	2,5	37	185,62	-
T-4060-041	64	2,5	41	263,18	-



Panel GN; melamina
Panel GN; melamine

Nr kat.	l cm	h cm	w cm	col	PLN	EUR
V-61302	32,5	2	17,6	biały	58,62	-
V-61303	32,5	2	17,6	czarny	58,62	-
V-61304	32,5	2	17,6	czarny	61,99	-

Verlo

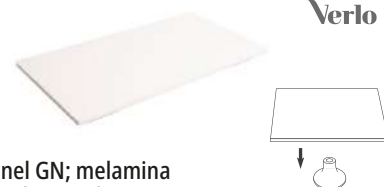

Panel GN; melamina
Panel GN; melamine

Nr kat.	l cm	h cm	w cm	col	PLN	EUR
V-61100 GN 1/1	53	3	32,5	biały	136,76	-
V-61200 GN 1/2	32,5	2	26,5	biały	80,51	-
V-61300 GN 1/3	32,5	2	17,3	biały	52,33	-

Podstawa; melamina
Base; melamine

Nr kat.	Ø cm	h cm	col	PLN	EUR
V-61301	15	9,5	biały	22,52	-



Taca bufetowa GN; melamina
Buffet tray GN; melamine

Nr kat.	l cm	h cm	w cm	col	PLN	EUR
V-1350-B	26,5	1,8	17,5	czarny	35,58	-





Łopátka do tortu; 18/10, drewno
Cake spatula; 18/10, wood

Nr kat.	l cm	PLN	EUR
T-207-25	25	8,15	-



Łopátka do tortu; 18/10
Cake server; 18/10

Nr kat.	l cm	thk mm	PLN	EUR
E-3050-8-1	23,1	2,5	50,06	-



Łopátka do tortu; 18/10
Cake server; 18/10

Nr kat.	l cm	thk mm	PLN	EUR
E-3010-8-1	25,6	4	67,64	-



Łopátka do tortu; 18/10
Cake server; 18/10

Nr kat.	l cm	thk mm	PLN	EUR
E-2080-8-1	25,9	3,5	89,64	-



Szczypce; 18/10
Tongs; 18/10

Nr kat.	l cm	w cm	PLN	EUR
T-12671	18,5	3,4	64,00	-



Szczypce; 18/10
Tongs; 18/10

Nr kat.	l cm	PLN	EUR
T-211-230	23	21,61	-
T-211-300	30	24,70	-



Szczypce; 18/10
Tongs; 18/10

Nr kat.	l cm	PLN	EUR
T-9400	20	17,90	-



Szczypce; 18/10
Tongs; 18/10

Nr kat.	l cm	PLN	EUR
T-9500	22	17,62	-



Więcej szczypiec na str. 64-65
Find more Tongs on pages 64-65



Syfon Kayser; 18/10
Siphon Kayser; 18/10

Nr kat.	cap ml	PLN	EUR
T-BS4051	500	431,00	-
T-BS4101	1000	456,00	-

W komplecie 2 końcówki do dekoracji
2 decoration nozzles included



Naboje do syfonu (kpl. 10szt.)
Cartridges for siphon (10 pcs)

Nr kat.	PLN	EUR
T-BSN-1111	25,00	-





Porcjoner; 18/10
Ice cream spoon; 18/10

Nr kat.	Ø cm	l cm	grm g	cap l	PLN	EUR
T-60-012	6,5	23,5	58	0,083	55,58	-
T-60-024	4,6	22	29	0,041	53,48	-
T-60-030	4,5	22	23	0,033	52,36	-
T-60-040	4	21,45	17	0,025	52,36	-
T-60-008	6,8	24	87	0,125	57,43	-



Porcjoner; 18/10
Ice cream spoon; 18/10

Nr kat.	Ø cm	l cm	grm g	cap l	PLN	EUR
T-STC17	4,1	22,5	17	0,025	193,22	-
T-STC19	4,4	23	19	0,028	193,22	-
T-STC23	4,5	23	23	0,033	193,22	-

Uchwyt powlekany mosiądzem i chromem
The handle coated with brass and chrom



Porcjoner; 18/10, tworzywo
Ice cream spoon; 18/10

Nr kat.	Ø cm	l cm	grm g	cap l	PLN	EUR
T-STK17	4,1	22	17	0,025	195,41	-
T-STK19	4,4	22	19	0,028	195,41	-
T-STK23	4,5	22,5	23	0,033	195,41	-



Porcjoner; Al polerowane
Ice cream spoon; Al. polished

Nr kat.	l cm	grm g	cap l	PLN	EUR
T-STA17	17	17	0,025	141,84	-
T-STA23	17,5	23	0,033	141,84	-

Rękojeść eutektyczna - ciepło dłoni rozgrzewa krawędź łyżki
Thermoactive handle - when gripped the warmth spreads over the whole spoon



de Buyer

Porcjoner; Al polerowane
Ice cream spoon; Al. polished

Nr kat.	l cm	cap l	PLN	EUR
D-4815-00N	18	0,033	51,30	-

Rękojeść eutektyczna - ciepło dłoni rozgrzewa krawędź łyżki
Thermoactive handle - when gripped the warmth spreads over the whole spoon



Porcjoner; 18/10, tworzywo
Ice cream spoon; 18/10

Nr kat.	l cm	PLN	EUR
T-41475	26	27,45	-



Porcjoner do lodów; Al polerowane
Ice cream disher; Al. polished

Nr kat.	l cm	cap l	PLN	EUR
T-70-120	18	0,015	14,26	-



KUP ON-LINE





PIZZERIA

- najlepszej jakości akcesoria
- kompleksowe wyposażenie



Łopata do pizzy; Al, drewno
Pizza peel; Al, wood

Nr kat.	l cm	tl cm	w cm	PLN	EUR
LO-2512	31	66,5	30,5	109,59	-
LO-3016	30,5	77	40,6	165,96	-
LO-3512	55	90	30,5	129,31	-
LO-4016	55	101	40,6	171,62	-
LO-5212	96	131,5	30,5	155,26	-
LO-5616	97	142	40,6	218,32	-



Łopata do pizzy; Al, drewno
Pizza peel; Al, wood

Nr kat.	Ø cm	l cm	tl cm	PLN	EUR
LO-17080	20,3	30	50,5	105,79	-
LO-17135	34	54,5	88,5	126,18	-
LO-17160	40,6	54,5	95	169,94	-



Wieszak na łopaty; Al
Hanger for peels; Al.

Nr kat.	l cm	w cm	PLN	EUR
MG-APM	18	9	122,69	-

Miejsce na dwie łopaty
A place for two peels

GIMETAL



GIMETAL



Wieszak na łopaty; Al
Hanger for peels; Al.

Nr kat.	l cm	w cm	PLN	EUR
MG-ACHPP3	21	7	80,80	-

Miejsce na trzy łopaty
A place for three peels

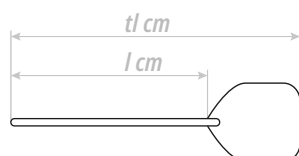

Wyjaśnienie symboli w tabelach z łopatami
Pizza peel tables abbreviations explained



Łopata do pizzy; anodowane Al.
Pizza shovel; anodized Al.

Nr kat.	Ø cm	l cm	tl cm	PLN	EUR
MG-A32180	33	180	212	505,08	-
MG-A50120	50	120	170	734,06	-

Trwała, specjalnie wyważona • Mocna, owalna rurowa konstrukcja uchwytu • Nitowane połączenie łopaty nie przenosi wibracji na uchwyt
Durable, specially balanced • Strong, oval tubular design of the handle • Riveted blade connection does not carry vibration on the handle



Łopata do pizzy Gi Metal Azzurra; anodowane Al
Pizza peel Gi Metal Azzurra; anodized Al.

Nr kat.	Ø cm	l cm	tl cm	PLN	EUR
MG-A32180F	33	180	212	628,00	-
MG-A50120F	50	120	170	876,73	-

Trwała, specjalnie wyważona • Perforacja usuwa nadmiar mąki z pizzy • Mocna, owalna rurowa konstrukcja uchwytu • Nitowane połączenie łopaty nie przenosi wibracji na uchwyt

Durable, specially balanced • Perforation removes excess flour from the pizza • Strong, oval tubular design of the handle • Riveted blade connection does not carry vibration on the handle



Łopata do pizzy; anodowane Al
Pizza shovel; anodized Al.

Nr kat.	l cm	tl cm	w cm	PLN	EUR
MG-A32180R	180	212	33	505,08	-
MG-A45120R	120	165	45	636,18	-
MG-A45060R	60	110	45	590,64	-

Trwała, specjalnie wyważona • Mocna, owalna rurowa konstrukcja uchwytu • Nitowane połączenie łopaty nie przenosi wibracji na uchwyt
Durable, specially balanced • Strong, oval tubular design of the handle • Riveted blade connection does not carry vibration on the handle



Łopata do pizzy Gi Metal Azzurra; anodowane Al
Pizza peel Gi Metal Azzurra; anodized Al.

Nr kat.	l cm	tl cm	w cm	PLN	EUR
MG-A32180RF	180	212	33	629,28	-
MG-A45120RF	120	165	45	739,22	-

Trwała, specjalnie wyważona • Mocna, owalna rurowa konstrukcja uchwytu • Nitowane połączenie łopaty nie przenosi wibracji na uchwyt

Durable, specially balanced • Perforation removes excess flour from the pizza • Strong, oval tubular design of the handle • Riveted blade connection does not carry vibration on the handle



Łopata do obracania pizzy Gi Metal Azzurra 18/10
Turning pizza peel Gi Metal Azzurra; 18/10

Nr kat.	Ø cm	l cm	tl cm	PLN	EUR
MG-I20-120	20	120	140	389,02	-
MG-I23-120	23	120	143	400,17	-



Łopata do pizzy Gi Metal Amica; anodowane Al
Pizza peel Gi Metal Aurora; anodized Al.

Nr kat.	l cm	tl cm	w cm	PLN	EUR
MG-AF37R-120	120	157	36	347,13	-
MG-AF37R-60	60	97	36	315,87	-
MG-AF41R-120	120	161	41	412,25	-
MG-AF41R-60	60	101	41	375,09	-

Mocna, owalna rurowa konstrukcja uchwytu • Nitowane połączenie łopaty nie przenosi wibracji na uchwyt

Strong, oval tubular design of the handle • The riveted blades connection does not transfer vibrations to the handle





Płyta do pizzy; anodyzowane Al.
Pizza board; anodized Al.

Nr kat.	l cm	w cm	PLN	EUR
MG-2550AF	50	25	271,40	-

Perforowana płyta do wypiekania pizzy „na metry”; świetnie nadaje się do wypiekania długiej focaccii, czy pizza Romana • Powierzchnia robocza: 25x40 cm

Perforated aluminium; perfect for pizza „by the metter”, long focaccia or pizza Romana • Working surface: 25x40 cm



Płyta do pizzy; anodyzowane Al.
Pizza board; anodized Al.

Nr kat.	l cm	w cm	PLN	EUR
MG-3070AF	70	30	409,40	-

Perforowana płyta do wypiekania pizzy „na metry”; świetnie nadaje się do wypiekania długiej focaccii, czy pizza Romana • Powierzchnia robocza: 30x60 cm

Perforated aluminium; perfect for pizza „by the metter”, long focaccia or pizza Romana • Working surface: 30x60 cm



Płyta do pizzy; anodyzowane Al.
Pizza board; anodized Al.

Nr kat.	l cm	w cm	PLN	EUR
MG-3090AF	90	30	501,40	-

Perforowana płyta do wypiekania pizzy „na metry”; świetnie nadaje się do wypiekania długiej focaccii, czy pizza Romana • Powierzchnia robocza: 30x80 cm

Perforated aluminium; perfect for pizza „by the metter”, long focaccia or pizza Romana • Working surface: 30x80 cm



Płyta do pizzy; anodyzowane Al.
Pizza board; anodized Al.

Nr kat.	l cm	w cm	PLN	EUR
MG-4070AF	70	40	501,40	-

Perforowana płyta do wypiekania pizzy „na metry”; świetnie nadaje się do wypiekania długiej focaccii, czy pizza Romana • Powierzchnia robocza: 40x60 cm

Perforated aluminium; perfect for pizza „by the metter”, long focaccia or pizza Romana • Working surface: 40x60 cm



Płyta do pizzy; anodyzowane Al.
Pizza board; anodized Al.

Nr kat.	l cm	w cm	PLN	EUR
MG-4090AF	90	40	593,40	-

Perforowana płyta do wypiekania pizzy „na metry”; świetnie nadaje się do wypiekania długiej focaccii, czy pizza Romana • Powierzchnia robocza: 40x80 cm

Perforated aluminium; perfect for pizza „by the metter”, long focaccia or pizza Romana • Working surface: 40x80 cm



Płyta do pizzy; anodyzowane Al.
Pizza board; anodized Al.

Nr kat.	l cm	w cm	PLN	EUR
MG-40110AF	110	40	685,40	-

Perforowana płyta do wypiekania pizzy „na metry”; świetnie nadaje się do wypiekania długiej focaccii, czy pizza Romana • Powierzchnia robocza: 40x100 cm

Perforated aluminium; perfect for pizza „by the metter”, long focaccia or pizza Romana • Working surface: 40x100 cm





GMETAL

Siatka do pizzy - GI Metal; Al
Pizza screen - Gi Metal; Al.

Nr kat.	Ø cm	PLN	EUR
MG-DF24	24	29,43	-
MG-DF26	26	31,92	-
MG-DF28	28	33,92	-
MG-DF30	30	37,16	-
MG-DF33	33	40,65	-
MG-DF36	36	45,69	-
MG-DF40	40	48,38	-
MG-DF45	45	57,58	-
MG-DF50	50	67,11	-
MG-DF55	55	123,24	-
MG-DF60	60	161,72	-

Wzmocniony, nienitowany rant z jednego kawałka aluminium • Rozmiar siatek do pizzy może różnić się od podanego o 2,5%

Reinforced, non-beatable edge of one piece of aluminum • Size of pizza grids may differ from the given by 2.5%



GMETAL

Stojak na siatki; 18/10
Pizza screen holder; 18/10

Nr kat.	l cm	h cm	w cm	PLN	EUR
MG-PRV	96 siatek	36	22	26	251,87 -

TOMGAST



Blacha do pizzy; stal niebieska
Pizza tray; blue steel

Nr kat.	Ø cm	h cm	PLN	EUR
T-1740-20	20	2,5	17,44	-
T-1740-22	22	2,5	21,80	-
T-1740-24	24	2,5	24,23	-
T-1740-26	26	2,5	25,68	-
T-1740-30	30	2,5	31,01	-
T-1740-32	32	2,5	33,92	-
T-1740-36	36	2,5	41,67	-
T-1740-40	40	2,5	49,42	-
T-1742-45	45	3,5	65,41	-
T-1742-50	50	3,5	75,10	-



TOMGAST

Blacha do pizzy; stal niebieska
Pizza tray; blue steel

Nr kat.	l cm	h cm	w cm	PLN	EUR
T-1745-400	39,5	3	29,5	106,64	-
T-1745-500	49,5	3	34,5	135,96	-
T-1745-600	59	3	39,5	161,50	-



KUP ON-LINE





Łyżka do sosów; 18/10
Pizza ladle; 18/10

Nr kat.	l cm	w cm	g	PLN	EUR
MG-MS90	35	9	170	110,32	-

Specjalne płaskie dno do rozsmarowywania sosu
Special flat bottom for spreading the sauce



Uchwyt do blach i form; 18/10
Pizza tray grip; 18/10

Nr kat.	l cm	PLN	EUR
T-K205	19	53,90	-



Pojemnik do ciasta na pizzę; PE
Pizza dough container; PE

Nr kat.	l cm	h cm	w cm	PLN	EUR
MG-6040	60	7,6	40	63,02	-
MG-6040-1	60		40	43,24	-

pokrywa do pojemnika



Wałek do ciasta; PE
Rolling pin; PE

Nr kat.	l cm	PLN	EUR
MG-MT34	39,5	73,12	-



Radełko; PP, 18/0
Pizza wheel; PP, 18/0

Nr kat.	Ø cm	PLN	EUR
T-80004	7	24,95	-



Radełko; PP, 18/10
Pizza wheel; PP, 18/10

Nr kat.	Ø cm	PLN	EUR
T-80044	10	34,00	-

N



Radełko; 18/10, PP
Pizza cutter; 18/10, PP

Nr kat.	Ø cm	l cm	PLN	EUR
MG-ROM	10	23	40,79	-

Ergonomiczny uchwyt
Ergonomic handle

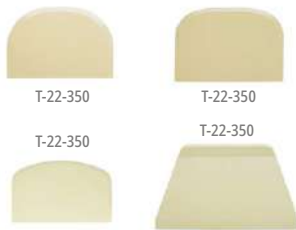

TOMGAST



TOMGAST



GIMETAL

Skrobka; tworzywo
Dough scraper; plastic

Nr kat.	l cm	w cm	PLN	EUR
T-22-365	11,2	7,8	4,09	-
T-22-355	12	8	3,80	-
T-22-231	13,7	8,6	4,66	-
T-22-350	22,1	13	14,88	-

Wybierak do ciasta; 18/10
Dough scraper; 18/10

Nr kat.	l cm	PLN	EUR
T-0075	12,5	20,66	-

Wybierak do ciasta; 18/10, PP
Dough scraper; 18/10, PP

Nr kat.	l cm	w cm	PLN	EUR
MG-TPF11	11,5	8	32,40	-
MT-TPM	15	7,5	29,45	-



TOMGAST



GIMETAL



GIMETAL

Szpachelka; 18/10
Scraper; 18/10

Nr kat.	l cm	w cm	PLN	EUR
T-112-502	23	8	44,54	-
T-112-504	24	12	55,49	-

Łopatka łamana; 18/10, PP
Spatula; 18/10, PP

Nr kat.	l cm	w cm	PLN	EUR
MG-AC-ST2M	11,5	7	46,87	-

Szpachelka; 18/10, PP
Spatula; 18/10, PP

Nr kat.	l cm	PLN	EUR
MG-AC-ST4M	trójkątna giętka 10	32,92	-
MG-STP32	giętka 11,5	78,80	-

KUP ON-LINE





Idealna do małych pieców elektrycznych
Perfect for small electric pizza ovens



Szczotka do małych pieców elektrycznych; mosiądz, Al.
Brush for small electric oven; brass, Al.

Nr kat.	l cm	h cm	w cm	PLN	EUR
MG-SP3-60	69	6	20	392,81	-

Szczotka o obniżonej wysokości (tylko 6 cm) – doskonale nadaje się do czyszczenia małych pieców elektrycznych, nie narażając grzałki na uszkodzenie.

Professional brush with lowered thickness (only 6cm) to allow an efficient cleaning of electric ovens with low height cooking deck.



Szczotka do pieca; mosiądz, stal, drewno
Brush for oven; brass, steel, wood

Nr kat.	l cm	h cm	w cm	PLN	EUR
MG-SPH	159	16	5	254,36	-



Szczotka do pieca; mosiądz, stal, drewno
Brush for oven; brass, steel, wood

Nr kat.	l cm	h cm	w cm	PLN	EUR
MG-ACSPBI	100	11,7	20	274,31	-



Szczotka do pieca; mosiądz, stal, drewno
Brush for oven; brass, steel, wood

Nr kat.	l cm	h cm	PLN	EUR
T-K1597	104	8	271,70	-



Szczotka do pieca; stal, drewno, PP
Brush for oven; steel, PP

Nr kat.	l cm	h cm	w cm	PLN	EUR
MG-SPGT	14,5	3,5	4	78,30	-





Łopata do pieca; 18/10
Shovel for oven; 18/10

Nr kat.	l cm	w cm	PLN	EUR
MG-PL	145	20	184,65	-



Skrobak do pieca; 18/10
Oven scraper; 18/10

Nr kat.	l cm	w cm	PLN	EUR
MG-RSL	154	24	132,39	-



Zbierak do pieca; 18/10
Scraper for oven; 18/10

Nr kat.	l cm	w cm	PLN	EUR
MG-SB	179	7,5	161,60	-



Oliwiarka; 18/10
Olive oil can; 18/10

Nr kat.	cap l	g	PLN	EUR
MG-OL10	1	320	125,93	-



Sprawdź talerze do pizzy z gwarancją na wyszczerbienia!
Check out pizza plates with edge chip warranty!



R-SPTBAPP33-6



R-SJDBAPP33-6



R-SSRBAPP33-6



R-SGRBAPP33-6



Talerz do pizzy
Pizza plate

Nr kat.	Ø cm	op.	PLN	EUR
R-SPTBAPP33-6	33	6	52,92	-
R-SJDBAPP33-6	33	6	52,92	-
R-SSRBAPP33-6	33	6	52,92	-
R-SGRBAPP33-6	33	6	52,92	-



KLASYKA

Ulubiony przez najlepsze restauracje z kuchni włoską!



Talerz do pizzy
Pizza plate

Nr kat.	Ø cm	col	op.	PLN	EUR
R-BAPP33-6	33	kość słoniowa	6	36,37	-

Gwarancja na wyszczerbienia • Odporny na zadrapania i mycie w zmywarkach
Chipping warranty • Scratch resistant and dishwasher safe



KUP ON-LINE



SOSJERKI

- perfekcyjne wykończenie
- bogactwo formy



Butelka z nalewakiem; 18/10, porcelana
Bottle with pourer; porcelain

Nr kat.	l cm	h cm	w cm	cap l	col	op.	PLN	EUR
RV-645302-6	8,3	16,5	7,9	0,25	czarny	2	133,49	-



Miseczka
Bowl

Nr kat.	Ø cm	cap ml	col	op.	PLN	EUR
RV-645843-6	7,5	40	biały	6	66,58	-
RV-645844-6	7,5	40	czerwony	6	66,58	-
RV-645845-6	7,5	40	czarny	6	66,58	-



Miseczka
Bowl

Nr kat.	Ø cm	h cm	cap ml	col	op.	PLN	EUR
RV-646421-6	8	6	150	biały	6	61,03	-
RV-646422-6	8	6	150	czerwony	6	61,03	-
RV-646423-6	8	6	150	czarny	6	61,03	-



Dzbanuszek
Bowl

Nr kat.	l cm	h cm	w cm	cap ml	col	op.	PLN	EUR
RV-644306-4	8,8	13	8	250	biały	4	95,77	-
RV-644378-4	8,8	13	8	250	czerwony	4	102,06	-
RV-644386-4	8,8	13	8	250	czarny	4	102,06	-





Mlecznik
Milk jug

Nr kat.	cap ml	op.	PLN	EUR
R-BACR05-24	50	24	21,32	-
R-BACR15-6	150	6	22,57	-
R-BACR25-6	250	6	26,33	-
R-BACR35-6	350	6	37,61	-



Mlecznik
Milk jug

Nr kat.	cap ml	op.	PLN	EUR
R-FDCR05-24	50	24	26,33	-
R-FDCR15-6	150	6	37,61	-
R-FDCR25-6	250	6	45,14	-
R-FDCR40-6	400	6	56,43	-



Mlecznik
Milk jug

Nr kat.	cap ml	op.	PLN	EUR
R-GIJU09-12	90	12	21,32	-
R-GIJU15-12	150	12	23,83	-



Sosjerka
Sauce boat

Nr kat.	cap ml	op.	PLN	EUR
R-BAGB15-6	150	6	42,63	-
R-BAGB35-4	350	4	43,89	-



Mlecznik
Milk jug

Nr kat.	cap ml	op.	PLN	EUR
R-NOCR15-6	150	6	22,57	-



Naczynie
Dish

Nr kat.	Ø cm	op.	PLN	EUR
R-ACY01-24	10	24	23,61	-



R-BABR01-12



R-BABR03-12



R-BABR02-12

Naczynie
Dish

Nr kat.	Ø cm	cap ml	op.	PLN	EUR
R-BABR01-12	7	60	12	12,54	-
R-BABR03-12	7	40	12	12,54	-
R-BABR02-12	8	100	12	13,79	-



Naczynie
Dish

Nr kat.	l cm	w cm	op.	PLN	EUR
R-BACD09-12	9	7	12	13,79	-





Przykładowy załadunek EPP180 (ładowany od góry):

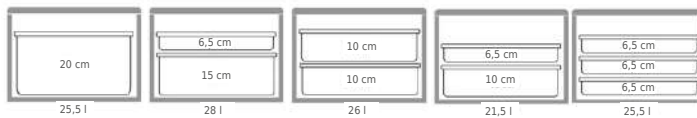

Przykładowy załadunek EPP300 (ładowany od przodu):



Przykładowy załadunek EPP400 (ładowany od przodu):

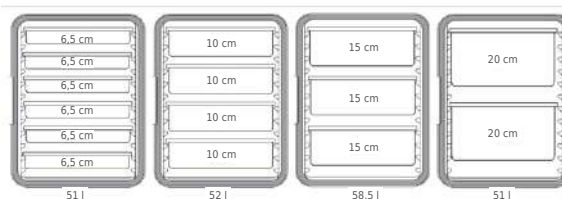

Termos cateringowy Camgo Box; PP
Catering thermos Camgo Box; PP

Nr kat.	l cm	h cm	w cm	kg	PLN	EUR
CM-EPP180	40	31,6	60	1,2	158,37	-



Termos cateringowy Camgo Box; PP
Catering thermos Camgo Box; PP

Nr kat.	l cm	h cm	w cm	kg	PLN	EUR
CM-EPP300	44	47,5	64,5	3,2	810,54	-



Termos cateringowy Camgo Box; PP
Catering thermos Camgo Box; PP

Nr kat.	l cm	h cm	w cm	kg	PLN	EUR
CM-EPP400	44	63	64,5	3,9	964,44	-



Termos cateringowy - grzewczy; PP
Catering thermos with heating; PP

Nr kat.	l cm	h cm	w cm	W	PLN	EUR
CM-UPCH4002	67	63	46	265	6 681,83	-



Termos cateringowy; PP
Catering thermos; PP

Nr kat.	l cm	h cm	w cm	col	PLN	EUR
CM-UPCS180	43,5	30,5	64	szary	1 229,97	-



Termos cateringowy; PP
Catering thermos; PP

Nr kat.	l cm	h cm	w cm	col	PLN	EUR
CM-UPCS400	63,5	63	46	szaro-niebieski	2 169,61	-

CM-CD300 fits: Fits: 1000LCD, UC1000, 300MPC, 1318MTC, UPCS140, UPCS160, UPCS180, UPCSS160



Wózek do termosów: UPCS140, UPCS160, UPCS180; PP
UPCS140, UPCS160, UPCS180 thermoses trolley; PP

Nr kat.	l cm	h cm	w cm	PLN	EUR
CM-CD160	62	26,5	42	1 731,38	-

136



Akcesoria do termosów UPC400 i UPCS 400
UPC400 and UPCS 400 thermos accessories

Nr kat.		Ø cm	l cm	h cm	w cm	PLN	EUR
CM-400DIV	przegroda	54	3,8	33		415,53	-
CM-CD400	wózek	71	23	53		1 931,45	-
CM-CP1220	wkład chłodzący	32,7	3,8	52,9		450,21	-
CM-UPCS400CK	komplet kół	12,7				859,28	-
CM-DIV12	wspornik do termosów	32,5				23,56	-



Termos cateringowy na napoje 10,5 l; PE
Beverages catering thermos 10.5 l; PE

Nr kat.	l cm	h cm	w cm	PLN	EUR
CM-UC250	42,5	50	30	1 364,58	-



Termos cateringowy na napoje 20 l; PE
Beverages catering thermos 20 l; PE

Nr kat.	l cm	h cm	w cm	PLN	EUR
CM-UC500	42,5	68	30	1 539,00	-



Termos cateringowy na napoje 40 l; PE
Beverages catering thermos 40 l; PE

Nr kat.	l cm	h cm	w cm	PLN	EUR
CM-UC1000	52	65,5	41,5	2 120,40	-





Termos cateringowy na napoje 5,7 l; PE
Beverages catering thermos 5.7 l; PE

Nr kat.	l cm	h cm	w cm	PLN	EUR
CM-100LCD	29	44	26,5	1 108,08	-



Termos cateringowy na napoje 9,4 l; PE
Beverages catering thermos 9.4 l; PE

Nr kat.	l cm	h cm	w cm	PLN	EUR
CM-250LCD	42	47	23	1 155,96	-



Termos cateringowy na napoje 18 l; PE
Beverages catering thermos 18 l; PE

Nr kat.	l cm	h cm	w cm	PLN	EUR
CM-500LCD	42	62	23	1 306,44	-



Termos cateringowy na zupę 12,7 l; PE
Soup catering thermos 12,7 l; PE

Nr kat.	l cm	h cm	w cm	PLN	EUR
CM-350LCD	42	47	23	1 128,60	-



Termos z kranem; stal nierdzewna, poliuretan
Thermos with tap; stainless steel, polyurethane

Nr kat.	Ø cm	h cm	cap l	PLN	EUR
T-120-12	24	47	12	155,70	-

N



Wózek do transportu talerzy; PP
Transport trolley for plates; PP

Nr kat.	l cm	h cm	w cm	PLN	EUR
CM-ADCS	73,9	82,2	96,2	5 941,21	-

Regulowana wielkość komór pozwala umieścić talerze o śr. od 11,7 do 33 cm
The adjustable size of the chambers allows you to place plates of dia. from 11.7 to 33 cm



Pojemnik do transportu porcelany Catering Box; PP
Catering Box for porcelain; PP

Nr kat.	l cm	h cm	w cm	cap l	kg	PLN	EUR	
T-50BOX	pojemnik	40	31	40	32	1,5	97,15	-
T-50BOX-D2	pokrywa	45		45		0,4	34,22	-
T-50BOX-VAK	przegroda	36	27,3	36			18,80	-
T-50BOX-VARY	tuba		29				18,60	-

Wentylacja, nawet przy zamkniętej pokrywie • Ruchome przegródki • Nośność do 200 kg • Mieści do 40 sztuk filiżanek i spodków • Odpowiedni do zastawy stołowej i do produktów spożywczych

Ventilation, even when the lid is closed • Movable compartments • Capacity up to 200 kg • Holds up to 40 cups and saucers • Suitable for tableware and food products



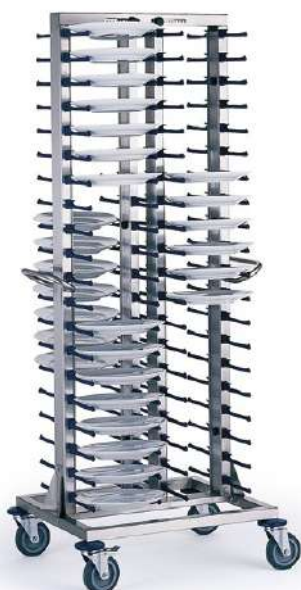

Mieści 80 talerzy • Ergonomiczne uchwyty
• Regulacja rozstawu uchwytów do średnicy talerza • Odległość między talerzami - 80 mm

Holds 80 plates • Ergonomic handles • Adjustment of the grip spacing to the plate diameter • Distance between plates - 80 mm

B.PRO



B.PRO

Wózek do transportu talerzy Serwistar Gastro 80; 18/10
Trolley for plates Serwistar Gastro 80; 18/10

Nr kat.	h cm	PLN	EUR
T-572301	185,6	8 337,97	-

Pokrowiec na Serwistar Gastro 80; 18/10, PET
Cover for Serwistar Gastro 80; 18/10, PET

Nr kat.	PLN	EUR
T-672301	3 600,00	-



Wózek kelnerski; PP, Al.
Service trolley; PP

Nr kat.	l cm	h cm	w cm	PLN	EUR
CM-BC331KD	83,5	96	42	767,65	-
CM-BC340KD	101,5	95	54	1 142,71	-

Estetyczny, wytrzymały, stabilny • Lekki i cichy dla komfortu gości • Słupki wykonane z aluminium • Do samodzielnego montażu

Aesthetic, durable, stable • Light and quiet for guest comfort • The bars are made of aluminum • For self-assembly



Zestaw ścianek do wózka kelnerskiego Cambro; PP
Panels for service trolley Cambro; PP

Nr kat.	PLN	EUR
CM-BC340KDP	197,93	-

W zestawie 3 panele na jedno piętro wózka
In the set of 3 panels for one floor of the trolley



Pojemniki do wózka kelnerskiego Cambro; PP
Container for service trolley Cambro; PP

Nr kat.	l cm	h cm	w cm	PLN	EUR
CM-BC331KDSH	33	18,5	24	107,02	-
CM-BC331KDTC	33	56	24	238,40	-



Więcej koszy na odpady znajdziesz na stronie nr 115

See more refuse bins on page 115





B.PRO

Wózek kelnerski Heavy Duty; 18/10
Service trolley Heavy Duty; 18/10

Nr kat.	l cm	h cm	w cm	kg	PLN	EUR
T-527-2	90	95	60	15	1 893,00	-
T-528-3	90	95	60	18	2 092,00	-

Spawana konstrukcja zapewnia odpowiednią stabilność • Wzmocnione, łożyskowane koła: 4 skrzętne, 2 z hamulcami • Gumowa wkładka zmniejszająca hałas • Ilość półek 2 - 3

Welded construction provides stability • Reinforced bearing wheels 4 castors, two brake • Rubber insert reducing the noise.



Wózek kelnerski; 18/10
Service trolley; 18/10

Nr kat.	l cm	h cm	w cm	kg	PLN	EUR
T-28-2	85,5	95	53	13	534,63	-
T-28-3	85,5	95	53	16	631,09	-

Konstrukcja skręcana śrubami • Koła: 4 skrzętne, 2 z hamulcami • Do samodzielnego montażu • Ilość półek 2 - 3

Bolted construction • Wheels: 4 swivel castors, 2 with brakes • For self-assembly

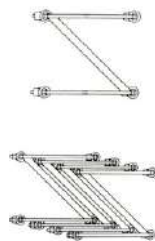

Wózek do tac GN 1/1; 18/10
GN 1/1 trolley; 18/10

Nr kat.	l cm	h cm	w cm	PLN	EUR
T-7711-11	55	173	38	977,38	-

Specjalna wzmocniona konstrukcja. Boczne „sztaplowanie” pustych wózków zajmuje mniej powierzchni magazynowej. Pojemność: 16 tac

A special reinforced construction enabling convenient storage of many trolleys. Capacity: 16 trays.

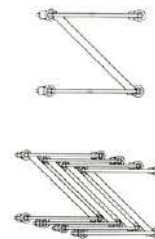

Wózek do tac GN 2/1; 18/10
GN 2/1 trolley; 18/10

Nr kat.	l cm	h cm	w cm	PLN	EUR
T-7721-21	67	173	59	1 089,52	-

Specjalna wzmocniona konstrukcja. Boczne „sztaplowanie” pustych wózków zajmuje mniej powierzchni magazynowej. Pojemność: 16 tac

A special reinforced construction enabling convenient storage of many trolleys. Capacity: 16 trays.



Ruszt GN; 18/10
Grate GN; 18/10

Nr kat.	l cm	w cm	PLN	EUR
T-R11001	53	32,5	65,55	-
T-R21001	65	53	130,70	-



Wózek platformowy; 18/10, PP
Platform trolley; 18/10, PP

Nr kat.	l cm	h cm	w cm	kg	PLN	EUR
T-142-11	73	86	49	8	640,47	-

2 koła skrzętne, brak hamulców • Do samodzielnego montażu
2 swivel castors, no brakes • For self-assembly



Wózek platformowy; 18/10
Platform trolley; 18/10

Nr kat.	l cm	h cm	w cm	kg	PLN	EUR
T-140-05	74	87	48	12	967,99	-

2 koła skrzętne, brak hamulca • Do samodzielnego montażu
2 swivel castors, no brakes • For self-assembly



Verlo



Słupki odgradzający z taśmą; 18/10
Post barrier with belt; 18/10

Nr kat.	l cm	h cm	PLN	EUR
T-92B	200	59,5	264,00	-
T-92R	200	59,5	264,00	-



Słupki odgradzający; 18/10
Post barrier; 18/10

Nr kat.	h cm	PLN	EUR
T-90102	99	197,60	-

Sznur do zamówienia osobno
Rope is not included



Stojak do tac; drewno
Tray jack; wood

Nr kat.	l cm	h cm	PLN	EUR
V-ST8746	43	87	376,88	-

Łatwe rozkładanie • drewno dębowe lakierowane w kolorze czarnym.
Easy to unfold • black lacquered oak wood.



Słupki odgradzający; 18/10
Post barrier; 18/10

Nr kat.	h cm	PLN	EUR
T-90118	95	197,60	-

Sznur do zamówienia osobno
Rope is not included



Tablica informacyjna; 18/10, PP
Information board; 18/10, PP

Nr kat.	h cm	PLN	EUR
T-HS1	40	135,85	-



Sznur do słupków odgradzających
Rope for post barrier

Nr kat.	l cm	col	PLN	EUR
T-9051B	150	czarny	117,33	-
T-9051R	150	czerwony	117,33	-

Verlo
BUFET SYSTEM



Stół cateringowy; PE
Catering table; PE

Nr kat.	l cm	h cm	w cm	kg	PLN	EUR
V-STP150	152	74	76	12	360,00	-
V-STP180	183	74	76	14	420,00	-

5 315



+



+



Stół cateringowy z czarnym pokrowcem; PE
Catering table with black cover; PE

Nr kat.	l cm	h cm	w cm	PLN	EUR
V-STP150PC	152	74	76	483,61	-
V-STP180PC	183	74	76	546,13	-

Stół cateringowy z białym pokrowcem; PE
Catering table with white cover; PE

Nr kat.	l cm	h cm	w cm	PLN	EUR
V-STP150PB	152	74	76	483,61	-
V-STP180PB	183	74	76	546,13	-



Stół 180 cm | 180 cm table

Pokrowiec na stół; poliester 94%, elastan 6%
Table cover; polyester 94%, elastane 6%

Nr kat.	col	PLN	EUR
N V-P180-B	beżowy	198,00	-
V-P180-G	szary	198,00	-
V-P180-K	czarny	198,00	-
V-P180-W	biały	198,00	-

Stół 150 cm | 150 cm table

Pokrowiec na stół; poliester 94%, elastan 6%
Table cover; polyester 94%, elastane 6%

Nr kat.	col	PLN	EUR
N V-P150-B	beżowy	194,00	-
V-P150-G	szary	177,34	-
V-P150-K	czarny	177,34	-
V-P150-M	różowy	177,34	-
V-P150-W	biały	177,34	-

KUP ON-LINE



KUP ON-LINE





Stół koktajlowy; PE
Cocktail table; PE

Nr kat.	Ø cm	h cm	kg	PLN	EUR
V-ST80	81	110	8,2	255,00	-



Stół koktajlowy z pokrowcem; PE
Cocktail table with cover; PE

Nr kat.	Ø cm	h cm	PLN	EUR
V-ST80PB	81	110	374,17	-
V-ST80PC	81	110	374,17	-



Pokrowiec na stół; poliester 94%, elastan 6%
Table cover; polyester 94%, elastane 6%

Nr kat.	Ø cm	col	PLN	EUR
N V-C80-B	81	beżowy	160,74	-
V-C80-G	81	szary	160,74	-
V-C80-K	81	czarny	160,74	-
V-C80-M	81	różowy	160,74	-
V-C80-W	81	biały	160,74	-



Top na stół koktajlowy; poliester 94%, elastan 6%
Top cover for cocktail table; polyester 94%, elastane 6%

Nr kat.	col	PLN	EUR
N V-N80-B	beżowy	59,23	-
V-N80-G	szary	59,23	-
V-N80-K	czarny	59,23	-
V-N80-W	biały	59,23	-





Stół cateringowy; PE, stal
Catering table; PE, steel

Nr kat.	Ø cm	h cm	kg	PLN	EUR
V-ST150	152	74	18,6	735,00	-
V-ST180	180	74	26	1 125,00	-

5 350



Pokrowiec na stół; poliester 94%, elastan 6%
Table cover; polyester 94%, elastane 6%

Nr kat.	col	PLN	EUR
V-180-W	biały	242,55	-
N V-180-K	czarny	242,55	-



Uchwyt do obrusów (komplet - 4 szt.); 18/10
Table cloth holder (set 4 pcs.)

Nr kat.	l cm	w cm	PLN	EUR
E-793	5	4	20,70	-



Krzesło cateringowe; PE
Catering chair; PE

Nr kat.	l cm	h cm	w cm	PLN	EUR
V-Y53	45	88	50	139,50	-

5



Pokrowiec na krzesło; poliester 94%, elastan 6%
Chair cover; polyester 94%, elastane 6%

Nr kat.	col	PLN	EUR
V-Y53-W	biały	102,30	-



Krzesło cateringowe z białym pokrowcem; PE
Catering chair with white cover; PE

Nr kat.	l cm	h cm	w cm	PLN	EUR
V-Y53PB	50	88	45	217,62	-

OSZCZĘDŹ

KUP ON-LINE



Verlo to marka oferująca wysokiej klasy asortyment bufetowy i wyposażenia stołowego. Połączenie najwyższej jakości, funkcjonalności oraz najnowszych trendów to kryterium stosowane przy produkcji elementów marki Verlo. Marka ta oferuje również kompleksowe wyposażenie sali bankietowej i imprez outdoorowych w podgrzewacze, meble cateringowe i wiele innych.

Verlo is a brand offering an assortment of high-quality buffet and catering products. The combination of very good quality, functionality and the latest trends in gastronomy is a criterion used by the producer of the Verlo brand. The brand also offers comprehensive furnishing of the banquet hall and provides outdoor events with heaters, catering furniture and many more.

Drewniane elementy VERLO **wymagają konserwacji**. Nie wolno ich myć w zmywarce.

*Wooden VERLO elements **need care and maintenance**. They're not dishwasher safe.*

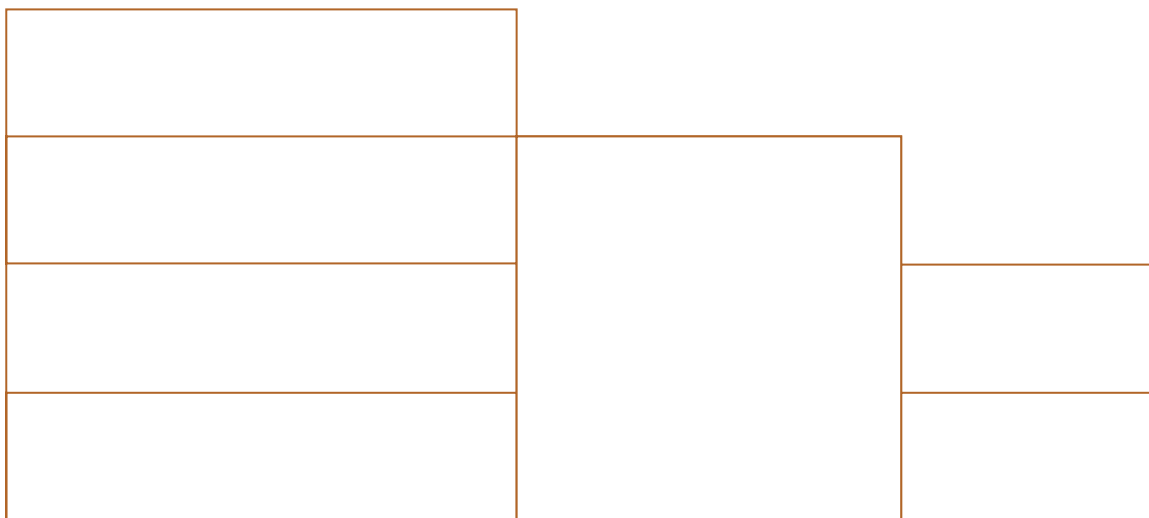

Drewniane elementy Verlo wykonane są z litego dębu i impregnowane olejem roślinnym, dzięki czemu są eleganckie, uniwersalne i praktyczne. Widoczne słoje nadają elementom modny, naturalistyczny charakter.

The Verlo elements are made of solid oak and impregnated with vegetable oil, due to that they are extremely elegant, universal and practical. visible rings give elements a fashionable, rustic character.

Moduły pozwalają konstruować bufet dopasowany do każdej przestrzeni. Tworzy to nieograniczone możliwości aranżacyjne.

The modules allow you to construct a buffet adapted to each space. This creates unlimited arrangement possibilities.

Forma, jakość, przeznaczenie, modne materiały, funkcjonalność mają ogromne znaczenie w branży gastronomicznej. Verlo to idealne rozwiązanie dla lokali ceniących sobie ponadczasowe rozwiązania.

Form, quality, purpose, fashionable materials, functionality are of great importance in the catering industry. Verlo is an ideal solution for premises that value timeless solutions.





N

Stół bufetowy mobilny; stal
Mobile buffet table; steel

Nr kat.	l cm	h cm	w cm	PLN	EUR
V-99901	120	81,5	80	3 200,00	-
V-99902	112	65	80	3 100,00	-

Podstawa z profilu stalowego 30 x 30 mm • 4 kółka skrętne z hamulcami • blat z laminatu kompozytowego o wymiarach: 114 x 74 cm (V-99901); 106 x 74 cm (V-99902) • grubość blatu: 2 cm
Base made of steel profile 30 x 30 mm • 4 swivel casters with brakes • composite laminate top with dimensions: 114 x 74 cm (V-99901); 106 x 74 cm (V-99902) • thickness of top: 2 cm



Wózek kelnerski do serwowania; dąb
Service trolley; oak

Nr kat.	l cm	h cm	w cm	PLN	EUR
V-99220	82	85	46	2 331,00	-

Fornir dębowy, lakierowany • 4 wysokiej jakości kółka skrętne, 2 z hamulcem
Oak veneer, lacquer finish • 4 swivel castors, 2 with brakes

KUP ON-LINE 



- Moduły pozwalają konstruować bufet dopasowany do każdej przestrzeni

- Units can be combined to create a unique scope of applications

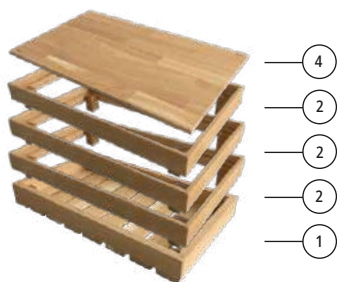

- Wykonane z litego dębu
- Impregnowane olejem naturalnym
- Widoczne słoje dębu
- Nie można myć w zmywarce
- Made of solid oak
- Impregnated with natural oil
- Visible natural veins of the wood
- Do not wash in dishwasher



1

Skrzynka GN 1/1; dąb
Chest GN 1/1; oak

Nr kat.	l cm	h cm	w cm	PLN	EUR
V-11002	53	6,5	32,5	279,93	-



3

Podstawa pod pojemnik GN 1/1; dąb
Chest GN 1/1; oak

Nr kat.	l cm	h cm	w cm	PLN	EUR
V-11004	53	8	32,5	158,55	-



2

Nakładka GN 1/1; dąb
Overlay GN 1/1; oak

Nr kat.	l cm	h cm	w cm	PLN	EUR
V-11003	53	8	32,5	144,90	-



4

Płyta GN 1/1; dąb
Panel GN 1/1; oak

Nr kat.	l cm	h cm	w cm	PLN	EUR
V-11001	53	2	32,5	266,78	-



1

Skrzynka GN 1/2; dąb
Chest GN 1/2; oak

Nr kat.	l cm	h cm	w cm	PLN	EUR
V-12002	32,5	6,5	26,5	171,32	-



3

Podstawa pod pojemnik GN 1/2; dąb
Chest GN 1/2; oak

Nr kat.	l cm	h cm	w cm	PLN	EUR
V-12004	32,5	8	26,5	120,75	-



2

Nakładka GN 1/2; dąb
Overlay GN 1/2; oak

Nr kat.	l cm	h cm	w cm	PLN	EUR
V-12003	32,5	8	26,5	110,31	-



4

Płyta GN 1/2; dąb
Panel GN 1/2; oak

Nr kat.	l cm	h cm	w cm	PLN	EUR
V-12001	32,5	2	26,5	148,60	-



1

Skrzynka GN 1/3 GN 2/4; dąb
Chest GN 1/3; oak

Nr kat.	l cm	h cm	w cm	PLN	EUR
V-13002	17,5	6,5	32,5	141,67	-
V-24002	53	5,5	16,2	193,41	-



4

Płyta GN 1/3; dąb
Panel GN 1/3; oak

Nr kat.	l cm	h cm	w cm	PLN	EUR
V-13001	17,5	2	32,5	99,98	-





Kolumna; stal
Column; steel

Nr kat.	l cm	h cm	w cm	PLN	EUR
V-9210-22	20	22	20	328,32	-
V-9210-34	20	34	20	414,00	-
V-9210-58	20	58	20	588,00	-

Stal malowana proszkowo
Powder-coated steel

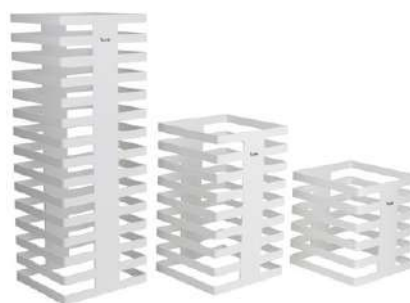

Kolumna; stal
Column; steel

Nr kat.	l cm	h cm	w cm	PLN	EUR
V-9110-22	20	22	20	328,32	-
V-9110-34	20	34	20	414,00	-
V-9110-58	20	58	20	588,00	-

Stal malowana proszkowo
Powder-coated steel



Kolumna; stal
Column; steel

Nr kat.	l cm	h cm	w cm	PLN	EUR
V-9010-22	20	22	20	328,32	-
V-9010-34	20	34	20	414,00	-
V-9010-58	20	58	20	588,00	-

Stal malowana proszkowo
Powder-coated steel





Panel; szkło hartowane
Panel; tempered glass

Nr kat.	l cm	h cm	w cm	PLN	EUR
V-SC1732	17,5	1	32,5	81,08	-
V-SC2632	26,5	1	32,5	120,25	-
V-SC3010	100	1	30	391,55	-
V-SC3030	30	1	30	127,49	-
V-SC3070	70	1	30	277,14	-
V-SC4210	100	1	42	388,84	-
V-SC4242	42	1	42	237,51	-
V-SC4270	70	1	42	376,91	-
V-SC5332	53	1	32,5	223,42	-



Panel; szkło hartowane
Panel; tempered glass

Nr kat.	l cm	h cm	w cm	PLN	EUR
V-SB1732	17,5	1	32,5	81,08	-
V-SB2632	26,5	1	32,5	120,25	-
V-SB5332	53	1	32,5	223,42	-





Płyta GN 1/2; dąb
Board GN 1/2; oak

Nr kat.	l cm	h cm	w cm	PLN	EUR
V-99001	32,5	2	26,5	151,75	-



Płyta GN 1/2; dąb bejcowany
Board GN 1/2; stained oak

Nr kat.	l cm	h cm	w cm	PLN	EUR
V-99002	32,5	2	26,5	161,41	-



Podstawa GN 1/2; 18/10
Stand GN 1/2; 18/10

Nr kat.	l cm	h cm	w cm	PLN	EUR
V-99121	32,5	9	26,5	518,70	-
V-99120	32,5	18	26,5	541,80	-

Wysoko polerowana
High polished



Podstawa GN 1/1; 18/10
Stand GN 1/1; 18/10

Nr kat.	l cm	h cm	w cm	PLN	EUR
V-99111	53	9	32,5	541,80	-
V-99110	53	18	32,5	588,00	-

Wysoko polerowana
High polished

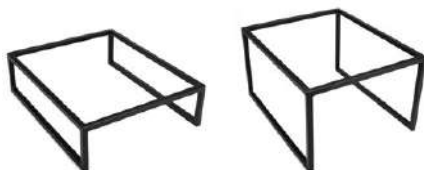

Podstawa GN 1/2; stal lakierowana
Stand GN 1/1; steel lacquered

Nr kat.	l cm	h cm	w cm	PLN	EUR
V-99123	32,5	9	26,5	329,00	-
V-99122	32,5	18	26,5	329,00	-

Czarny lakier
Black lacquer finish

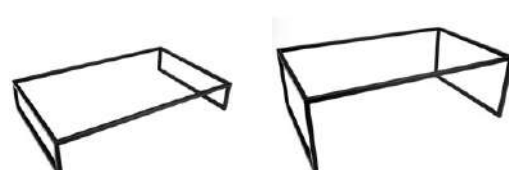

Podstawa GN 1/1; stal lakierowana
Stand GN 1/1; steel lacquered

Nr kat.	l cm	h cm	w cm	PLN	EUR
V-99113	53	9	32,5	359,00	-
V-99112	53	18	32,5	359,00	-

Czarny lakier
Black lacquer finish



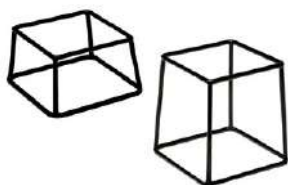

Podstawa bufetowa; stal, ABS
Buffet basis; steel, ABS

Nr kat.	l cm	h cm	w cm	PLN	EUR
V-351	18	10	15	43,61	-
V-352	18	18	15	51,30	-



Półmisek; porcelana
Dish; porcelain

Nr kat.	l cm	w cm	op.	PLN	EUR
R-CLSP27-12	27	27	12	58,93	-



Miska; porcelana
Bowl; porcelain

Nr kat.	l cm	h cm	w cm	cap ml	op.	PLN	EUR
R-CLSB21-6	21	4,5	21	650	6	56,43	-



Miska; porcelana
Bowl; porcelain

Nr kat.	l cm	h cm	w cm	cap ml	op.	PLN	EUR
R-CLSB14-12	14	4,5	14	320	12	28,84	-



Verlo

Półmisek bufetowy; porcelana
Dish; porcelain

Nr kat.	l cm	w cm	op.	PLN	EUR
V-BURT52-6	52	24	6	231,01	-

KUP ON-LINE





Skrzynka sztaplowana GN; dąb
Stackable GN case; oak

Nr kat.		l cm	w cm	thk mm	PLN	EUR
V-11411	GN 1/1	53	32,5	5	406,14	-
V-11412	GN 1/2	32,5	26,5	5	232,42	-
V-11413	GN 1/3	17,5	32,5	5	168,78	-
V-11414	GN 1/4	26,5	16,2	5	128,36	-



Skrzynka sztaplowana GN - tabak; dąb
Stackable GN case - tabak; oak

Nr kat.		l cm	w cm	thk mm	PLN	EUR
V-11411T	GN 1/1	53	32,5	5	426,17	-
V-11412T	GN 1/2	32,5	26,5	5	243,77	-
V-11413T	GN 1/3	17,5	32,5	5	176,95	-
V-11414T	GN 1/4	26,5	16,2	5	134,50	-





stalowe nóżki zapobiegają
przesuwaniu się płyty w skrzynce
*steel feet prevent the glass from
moving inside the case*



Płyta szklana GN z nóżkami; barwione szkło
Tempered dark glass with feet GN; glass

Nr kat.		l cm	w cm	thk mm	PLN	EUR
V-SC5332N	GN 1/1	53	32,5	8	284,84	-
V-SC2632N	GN 1/2	32,5	26,5	8	194,27	-
V-SC1732N	GN 1/3	17,5	32,5	8	159,83	-



KUP ON-LINE



Zobacz również słoiki marki WECK na str. 275, 288
See WECK jars on pages 275, 288



Podstawa; dąb
Stand; oak

Nr kat.	l cm	h cm	w cm	PLN	EUR
V-11522	50	13	15,5	259,14	-



Podstawa; dąb
Stand; oak

Nr kat.	l cm	h cm	w cm	PLN	EUR
V-11523	60	17	15,5	291,69	-



Podstawa okrągła na nogach - wysoka; dąb
Round stand - high; oak

Nr kat.	Ø cm	h cm	thk mm	PLN	EUR
V-11538P	28	17,5	20	258,86	-



Podstawa okrągła na nogach - niska; dąb
Round stand - low; oak

Nr kat.	Ø cm	h cm	thk mm	PLN	EUR
V-11537P	28	12,5	25	245,96	-



Patera niska; dąb
Cake stand - low; oak

Nr kat.	Ø cm	PLN	EUR
V-11548	28	412,65	-



Patera; drewno
Plateau; wood

Nr kat.	Ø cm	h cm	PLN	EUR
RV-650743-1	20,5	10	240,07	-





Klosz z podstawą; szkło, drewno
Cloche with basis; glass, wood

Nr kat.	Ø cm	h cm	PLN	EUR
RV-650900-1	20	24	392,14	-
RV-650898-1	30,5	25	478,89	-



Klosz; szkło
Cloche; glass

Nr kat.	Ø cm	h cm	PLN	EUR
RV-650878-1	18	21	291,94	-
RV-650492-1	27,2	24	345,29	-



Pokrywa; 18/10
Cover; 18/10

Nr kat.	Ø cm	h cm	PLN	EUR
P-9322	28	15	229,14	-

Do talerzy o śr. max. 27 cm
Max. dia. of plate 27 cm



CAMBRO

Pokrywa do talerza; PC
Plate cover; PC

Nr kat.	Ø cm	PLN	EUR
CM-1202CW152	30,8	58,24	-



Taca; łupek
Tray; slate

Nr kat.	l cm	w cm	PLN	EUR
TF-099	52	32,5	81,98	-



Taca; łupek
Tray; slate

Nr kat.	Ø cm	PLN	EUR
TF-098	33	43,55	-



Patera; łupek
Plateau; slate

Nr kat.	Ø cm	h cm	PLN	EUR
TF-089	20/25	24	75,05	-

Blim[®]

N

Patera; polipropylen, poliwęglan
Plateau; polypropylene, polycarbonate

Nr kat.	Ø cm	h cm	col	PLN	EUR
○ BP-AZ1-000	30	24	krystaliczny biały	161,79	-
● BP-AZ1-010	30	24	karbon	161,79	-
● BP-AZ1-314	30	24	leśny średni	161,79	-
● BP-AZ1-319	30	24	mokka	161,79	-
● BP-AZ1-335	30	24	morela	161,79	-
● BP-AZ1-336	30	24	cukier trzciniowy	161,79	-

zawiera pokrywę i łopatkę
includes lid and spatula



Patera; 18/10, szkło
Plateau; 18/10, glass

Nr kat.	Ø cm	h cm	PLN	EUR
T-17504	20/25	28	71,38	-
T-17507	20/25/40	40	91,27	-

Blim[®]

N

Pokrywa do patery; poliwęglan
Cover for the plate; polycarbonate

Nr kat.	Ø cm	h cm	col	PLN	EUR
BP-CT2-001	30	12	transparentny	80,49	-





Patera; melamina
Plateau; melamine

Nr kat.	Ø cm	h cm	PLN	EUR
T-72-029	24	3	83,52	-
T-72-025	30	3	85,25	-



Talerz płaski; melamina
Flat plate; melamine

Nr kat.	Ø cm	col	PLN	EUR
V-63300	33	biały	87,31	-



Podstawa; melamina
Base; melamine

Nr kat.	Ø cm	h cm	col	PLN	EUR
V-61301	15	9,5	biały	22,52	-

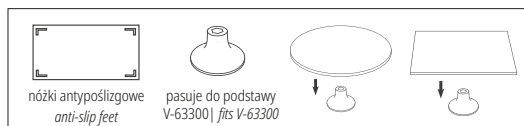

Verlo



Podstawa; melamina
Stand; melamine

Nr kat.	h cm	col	PLN	EUR
V-5207-CH	18	beżowy	49,80	-
V-5207-P	18	brudny róż	49,80	-

Antypoślizgowe nóżki • łatwy montaż i demontaż • pasuje do miski niskiej V-2262-P i V-2262-CH oraz patery V-4112-P i V-4112-PCH

Non-slip feet • easy installation and removal • fits V-2262-P and V-2262-CH low bowl and V-4112-P and V-4112-PCH platter.



Verlo



Podstawa; melamina
Stand; melamine

Nr kat.	h cm	col	PLN	EUR
V-5304-CH	10	beżowy	36,45	-
V-5304-P	10	brudny róż	36,45	-

Antypoślizgowe nóżki • łatwy montaż i demontaż • pasuje do miski niskiej V-2262-P i V-2262-CH oraz patery V-4112-P i V-4112-PCH

Non-slip feet • easy installation and removal • fits V-2262-P and V-2262-CH low bowl and V-4112-P and V-4112-PCH platter.



Verlo



Miska niska; melamina
Bowl low; melamine

Nr kat.	Ø cm	h cm	cap l	col	PLN	EUR
V-2262-CH	35	7	4,3	beżowy	74,10	-
V-2262-P	35	7	4,6	brudny róż	74,10	-

Możliwość zamontowania podstawy V-5304-CH; V-5304-P; V-5207-CH; V-5207-P
Possibility to mount base V-5304-CH; V-5304-P; V-5207-CH; V-5207-P



Verlo



Patera; melamina
Plateau; melamine

Nr kat.	Ø cm	col	PLN	EUR
V-4112-CH	33	beżowy	64,05	-
V-4112-P	33	brudny róż	64,05	-

Możliwość zamontowania podstawy V-5304-CH; V-5304-P; V-5207-CH; V-5207-P
Possibility to mount base V-5304-CH; V-5304-P; V-5207-CH; V-5207-P

KUP ON-LINE



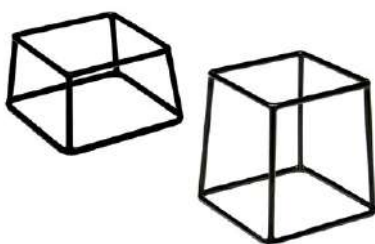

Podstawa bufetowa; stal, ABS
Buffet basis; steel, ABS

Nr kat.	l cm	h cm	w cm	PLN	EUR
V-351	18	10	15	43,61	-
V-352	18	18	15	51,30	-



Podstawa bufetowa; stal, PVC
Buffet stand; steel, PVC

Nr kat.	Ø cm	h cm	col	PLN	EUR
V-7508	21,2	10	czarny	37,27	-
V-7509	13,8	15	czarny	35,63	-
V-7510	25	20	czarny	44,02	-

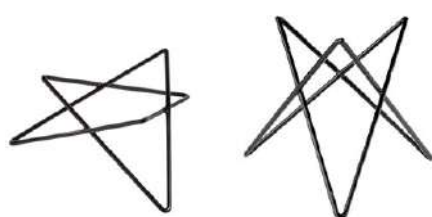

Podstawa bufetowa; stal, PVC
Buffet stand; steel, PVC

Nr kat.	l cm	h cm	w cm	col	PLN	EUR
V-7506	25	10	25	czarny	29,93	-
V-7507	25	20	25	czarny	44,89	-





Podstawa bufetowa; stal, PVC
Buffet stand; steel, PVC

Nr kat.	Ø cm	h cm	col	PLN	EUR
V-7504	25	20	złoty	55,32	-
V-7505	25	20	miedziany	55,32	-



Podstawa bufetowa; stal, PVC
Buffet stand; steel, PVC

Nr kat.	Ø cm	h cm	col	PLN	EUR
V-7502	25	10	złoty	37,48	-
V-7503	25	10	miedziany	37,48	-



Podstawa bufetowa; stal, PVC
Buffet stand; steel, PVC

Nr kat.	Ø cm	h cm	col	PLN	EUR
V-7500	15	10	złoty	29,63	-
V-7501	15	10	miedziany	29,63	-



Koszyk bufetowy; stal, PVD
Buffet basket; steel, PVD

Nr kat.	Ø cm	h cm	PLN	EUR
TF-323	15	11	127,30	-



Podstawa bufetowa; stal, ABS
Buffet basis; steel, ABS

Nr kat.	h cm	PLN	EUR
TF-3360	8	70,30	-
TF-3361	12	83,13	-
TF-3362	18	95,00	-





Stojak bufetowy; 18/10
Buffet stand; 18/10

Nr kat.		l cm	h cm	w cm	PLN	EUR
V-71100	GN 1/1	56,5	32,5	53	114,96	-
V-71200	GN 1/2	53	32,5	36	103,55	-
V-71300	GN 1/3	53	32,5	36	126,71	-



Stojak bufetowy GN 1/1, 18/0
Buffet stand; 18/0

Nr kat.	l cm	h cm	w cm	PLN	EUR
TF-05	50	37,5	34	427,50	-

Odległość między poziomami ok. 26 cm
Distance between levels approx. 26 cm



Półmisek owalny; 18/10
Oval dish; 18/10

Nr kat.	l cm	w cm	PLN	EUR
T-11265	25	18	23,34	-
T-11365	30	22	29,02	-
T-11464	35	22	37,42	-
T-11564	40	26	54,22	-
T-11764	50	35	86,82	-
T-12064	61	45	128,19	-



Kosz GN 1/1; poliratan
Basket GN 1/1; polirattan

Pasują do stojaków:
Stands fitting:

V-71100
TF-05

Nr kat.	l cm	w cm	col	PLN	EUR
T-2079-061	52	32,5	brązowy	109,25	-
T-2079-301	52	32,5	beżowy	109,25	-



Taca sztaplowalna GN 1/1; 18/10
Stackable tray GN 1/1; 18/10

Nr kat.	l cm	w cm	PLN	EUR
T-1380-53	53	32	220,80	-



Taca; 18/10
Tray; 18/10

Nr kat.	l cm	h cm	w cm	PLN	EUR
T-4060-019	25	2,5	19	41,00	-
T-4060-022	28	2,5	22	49,65	-
T-4060-024	31	2,5	24	53,97	-
T-4060-026	34	2,5	26	69,16	-
T-4060-028	40	2,5	28	82,13	-
T-4060-032	46	2,5	32	112,26	-
T-4060-037	55	2,5	37	185,62	-
T-4060-041	64	2,5	41	263,18	-





Etażera bufetowa; 18/0, szkło, SAN
Etager; 18/0, glass

Nr kat.	Ø cm	h cm	PLN	EUR
TF-04	30	48	617,50	-

Drabinka chromowana • Do dżemów, miódów, powideł • W komplecie: 4 szklane miseczki (śr. 14 cm), 4 uchylne pokrywy z wycięciem na łyżkę i miejscem na etykietę produktu • Pasują również porcelanowe miski BABW14 • Zapasowe miski i pokrywy na zamówienie

Chrome ladder • For jams, honeys, plum • Including: 4 glass bowls (14 cm diameter), 4 hinged lid with a notch for the spoon and a place for the product label • Also fit porcelain bowls BABW14 • Spare bowls and lids on order



Etażera; 18/0, szkło, SAN
Etager; 18/0, SAN

Nr kat.	l cm	h cm	w cm	PLN	EUR
TF-1195	61	35	24	646,00	-

W komplecie: 3 misy szklane (śr. 23 cm, poj. 2,5 l) z uchylnymi pokrywami z wycięciem na łyżkę i miejscem na etykietę

Includes: 3 glass bowls (average 23 cm, capacity 2.5 l) with hinged lid with a notch for the spoon and a place for the label



Etażera; 18/0, SAN
Etager; 18/0, SAN

Nr kat.	l cm	h cm	w cm	PLN	EUR
TF-14	19	41	24	234,81	-

Satynowany • Pojemnik z tworzywa sztucznego (poj. 1l)

Includes: 3 glass bowls (average 23 cm, capacity 2.5 l) with hinged lid with a notch for the spoon and a place for the label



Wieszak bufetowy; buk
Hanger; beech

Nr kat.	Ø cm	h cm	PLN	EUR
TF-553	28	50	104,40	-



Podstawa chłodząca; 18/10, akryl
Cooling buffet display; 18/10, acrylic

Nr kat.	l cm	h cm	w cm	PLN	EUR
TF-151	61	26	38	1 064,00	-

W zestawie: stalowa taca płaska i głęboka, ramka akrylowa i 2 wkłady chłodzące • Pokrywa do dokupienia oddzielnie

Includes: flat and deep steel tray, acrylic frame and 2 cooling cartridges • lid to be purchased separately



Taca z pokrywą; 18/10, SAN
Buffet plate with cover; 18/10

Nr kat.	Ø cm	h cm	PLN	EUR
TF-090	38	24	185,25	-

W zestawie: stalowa taca, transparentna pokrywa typu roll-top
Included: steel tray, transparent roll-top cover

KUP ON-LINE





Skrzynka ukośna GN 1/2; dąb
Miter chest GN 1/2; oak

Nr kat.	l cm	h cm	w cm	PLN	EUR
V-12011	32,5	8/11	26,5	237,51	-



Skrzynka ukośna z przegrodą GN 1/2; dąb
Miter chest with divider GN 1/2; oak

Nr kat.	l cm	h cm	w cm	PLN	EUR
V-12010	32,5	8/11	26,5	268,38	-



Stojak na bagietki; dąb
Baguette stand; oak

Nr kat.	l cm	h cm	w cm	PLN	EUR
V-1504	17,5	26,5	17,5	329,28	-



Deska do krojenia pieczywa GN 1/1; dąb
Bread cutting board GN 1/1; oak

Nr kat.	l cm	h cm	w cm	PLN	EUR
V-11005	53	6,5	32,5	600,00	-



Deska do krojenia pieczywa GN 1/1; dąb
Bread cutting board; oak

Nr kat.	l cm	h cm	w cm	PLN	EUR
V-11011	53	4	32,5	233,00	-



Noż kuty do pieczywa
Forged bread knife

Nr kat.	l cm	PLN	EUR
V-8260W200	20	345,04	-

Kuty • Rękojeść z drewna oliwnego
Forged • An olive wood handle



Podstawa bufetowa; dąb
Buffet stand; oak

Nr kat.	l cm	h cm	w cm	PLN	EUR
V-1501	17,5	16,5	17,5	194,25	-
V-1502	17,5	20	17,5	257,25	-
V-1503	17,5	25	17,5	320,25	-



Podstawa skośna niska GN 1/1; dąb
Miter, low stand GN 1/1; oak

Nr kat.	l cm	h cm	w cm	PLN	EUR
V-11007	53	3/10	32,5	173,60	-

Pasuje do skrzynek Verlo V-11002, V-12002, V-13002, V-24002
Fits for Verlo chest V-11002, V-12002, V-13002, V-24002



Podstawa skośna wysoka GN 1/1; dąb
Miter, high stand GN 1/1; oak

Nr kat.	l cm	h cm	w cm	PLN	EUR
V-11008	53	10/19	32,5	245,20	-

Pasuje do skrzynek Verlo V-11002, V-12002, V-13002, V-24002
Fits for Verlo chest V-11002, V-12002, V-13002, V-24002





Skrzynka GN 2/4; dąb
Chest GN 2/4; oak

Nr kat.	l cm	h cm	w cm	PLN	EUR
V-24002	53	5,5	16,2	193,41	-



Skrzynka ukośna na sztućce; dąb
Diagonal chest for cutlery; oak

Nr kat.	l cm	h cm	w cm	PLN	EUR
V-11010	53	6,5	32,5	365,20	-



Worek na pieczywo GN
GN Bread bag

Nr kat.	l cm	h cm	w cm	PLN	EUR	
V-366	GN 1/1	57	22	37	55,00	-

Pasuje na V-11002 + 2x V-11003
Fits V-11002 + 2x V-11003



Worek na pieczywo GN
GN Bread bag

Nr kat.	l cm	h cm	w cm	PLN	EUR	
V-367	GN 1/2	37	22	31	48,40	-

Pasuje na V-12002 + 2x V-12003
Fits V-12002 + 2x V-12003



Skrzynka z elementem chłodzącym; dąb
Chest with cooling element; oak

Nr kat.	l cm	h cm	w cm	PLN	EUR
V-11006	54	6,5	33	549,00	-

Pasuje do poj. GN 1/1 20 mm. Sprzedawana bez pojemnika.
Matching GN 1/1 20 mm. Container not included.



Pokrywa roll top; PC
Cover roll top GN 1/1; PC

Nr kat.	l cm	h cm	w cm	col	PLN	EUR
V-61199	53	17	32,5	przezroczysty	145,35	-



Wkład chłodzący
Cooling element

Nr kat.	l cm	h cm	w cm	col	PLN	EUR
V-6999	26,5	2,5	20	czarny	117,99	-



Pojemnik GN 1/1; porcelana
Container GN 1/1; porcelain

Nr kat.	l cm	h cm	w cm	col	op.	PLN	EUR
V-BUGN-11022-2	53,5	2,2	33,5	biały	2	306,35	-

Pojemnik dopasowany do skrzynki V-11006
Container fits V-11006 chest.





Verlo

Skrzynka GN 1/1; dąb
Chest GN 1/1; oak

Nr kat.	l cm	h cm	w cm	PLN	EUR
V-11002	53	6,5	32,5	279,93	-
V-12002	32,5	6,5	26,5	171,32	-



Verlo

Deska do krojenia pieczywa GN 1/1; dąb
Bread cutting board; oak

Nr kat.	l cm	h cm	w cm	PLN	EUR
V-11011	53	4	32,5	233,00	-

Stojak bufetowy; drewno
Buffet stand; wood

Nr kat.	l cm	h cm	w cm	PLN	EUR
TF-32	40	58,5	40	109,25	-

Nie zawiera koszyków
Baskets are not includedKoszyk; wiklina
Basket; wicker

Nr kat.	l cm	h cm	w cm	PLN	EUR
SZ-11	53	10	32,5	98,00	-

Produkcja ręczna • Wymiary produktu mogą nieznacznie różnić się od podanych

Hand-made • The dimensions of the product may slightly differ from the ones given

Koszyk; wiklina
Basket; wicker

Nr kat.	l cm	h cm	w cm	PLN	EUR
SZ-429	42	9	24	60,00	-

Produkcja ręczna • Wymiary produktu mogą nieznacznie różnić się od podanych

Hand-made • The dimensions of the product may slightly differ from the ones given

Koszyk; polipropylene
Basket; polypropylene

Nr kat.	Ø cm	h cm	col	PLN	EUR
T-4044-301	39	10	beżowy	87,40	-

Pasuje do stojaka bufetowego TF-32
Fits the TF-32 buffet stand

Verlo

N

Koszyk; wiklina
Basket; wicker

Nr kat.	Ø cm	h cm	PLN	EUR
SZ-3820	20	6	19,00	-
SZ-3800	38	10	52,00	-

Produkcja ręczna • Wymiary produktu mogą nieznacznie różnić się od podanych

Hand-made • The dimensions of the product may slightly differ from the ones given

Stojak do koszy asymetrycznych; 18/0
Stand for asymmetric baskets; 18/0

Nr kat.	Ø cm	l cm	h cm	PLN	EUR
T-90-334	35,5	42,5	47,5	323,00	-

Koszyk asymetryczny; PP
Asymmetric basket; PP

Nr kat.	Ø cm	h cm	PLN	EUR
T-2077-301	31 / 37	6 / 12	114,86	-

Koszyk; PP
Basket; PP

Nr kat.	l cm	h cm	w cm	col	PLN	EUR
T-2002-061	25	5	17	brązowy	36,77	-
T-2002-301	25	5	17	beżowy	36,77	-





Verlo

Kosz GN 1/1; PP
Basket GN 1/1; PP

Nr kat.	l cm	w cm	col	PLN	EUR
T-2079-061	52	32,5	brązowy	109,25	-
T-2079-301	52	32,5	beżowy	109,25	-



Verlo

Koszyk; PP
Basket; PP

Nr kat.	l cm	h cm	w cm	col	PLN	EUR
T-2081-061	32,5	6,5	35,4	brązowy	86,45	-
T-2081-301	32,5	6,5	35,4	beżowy	86,45	-



Verlo

Koszyk; PP
Basket; PP

Nr kat.	l cm	h cm	w cm	col	PLN	EUR
T-2085-061	32,5	6,5	17,6	brązowy	54,15	-
T-2085-301	32,5	6,5	17,6	beżowy	56,05	-



Verlo

Koszyk; PP
Basket; PP

Nr kat.	l cm	h cm	w cm	col	PLN	EUR
T-2083-061	32,5	6,5	26,5	brązowy	66,03	-
T-2083-301	32,5	6,5	26,5	beżowy	66,03	-



Verlo

Koszyk; PP
Basket; PP

Nr kat.	l cm	h cm	w cm	col	PLN	EUR
T-2087-061	16,2	6,5	26,5	brązowy	41,80	-
T-2087-301	16,2	6,5	26,5	beżowy	41,80	-



Verlo

Koszyk; PP
Basket; PP

Nr kat.	l cm	h cm	w cm	col	PLN	EUR
T-2089-061	17,6	6,5	16,2	brązowy	29,45	-
T-2089-301	17,6	6,5	16,2	beżowy	29,45	-



Kosz z pokrywą; ratan, SAN
Basket with cover; rattan, SAN

Nr kat.	Ø cm	l cm	w cm	PLN	EUR
AB-770-R50		50	29,5	425,98	-
AB-770-T44	44			481,59	-



Koszyk; wiklina
Basket; wicker

Nr kat.	l cm	h cm	w cm	PLN	EUR
SZ-1500	21	6	16	28,00	-
SZ-1000	28	6	20	19,00	-

Produkcja ręczna • Wymiary produktu mogą nieznacznie różnić się od podanych
Hand-made • The dimensions of the product may slightly differ from the ones given

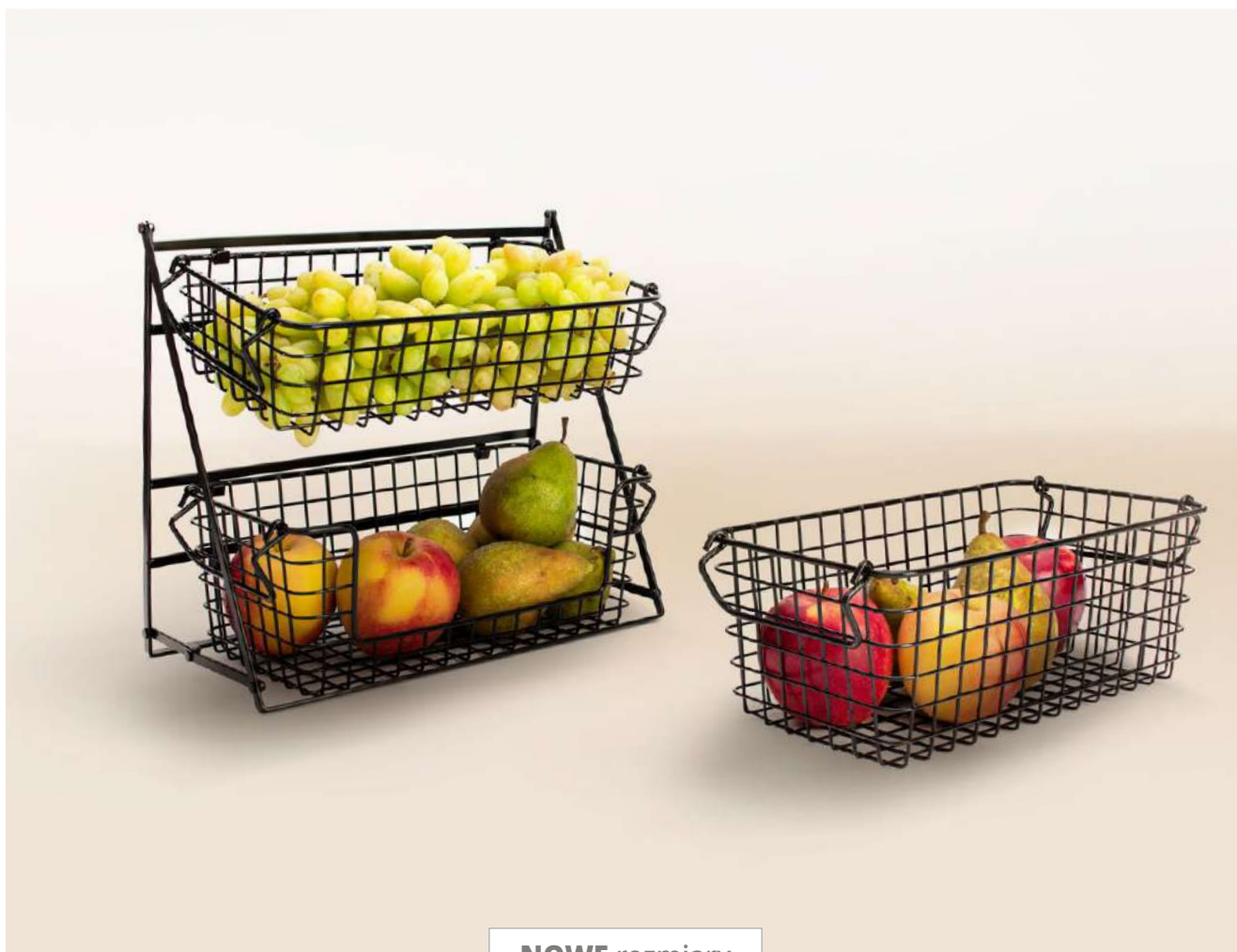

NOWE rozmiary

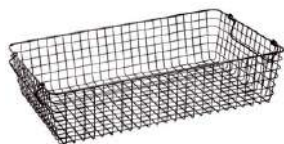

N

Kosz GN 1/1; stal
Basket GN 1/1; steel

Nr kat.	l cm	h cm	w cm	col	PLN	EUR
V-71101	51,8	12	31,3	czarny	114,95	-

Kosz GN 1/1; stal
Basket GN 1/1; steel

Nr kat.	l cm	h cm	w cm	col	PLN	EUR
V-71102	52	8	31,5	czarny	114,44	-

Worek na pieczywo GN
GN Bread bag

Nr kat.	→ □	l cm	h cm	w cm	PLN	EUR
V-366	GN 1/1	57	22	37	55,00	-



Kosz GN 1/2; stal
Basket GN 1/2; steel

Nr kat.	l cm	h cm	w cm	col	PLN	EUR
V-71201	31,3	12	25,3	czarny	112,75	-

Worek na pieczywo GN
GN Bread bag

Nr kat.	l cm	h cm	w cm	PLN	EUR	
V-367	GN 1/2	37	22	31	48,40	-



N

Kosz GN 1/2; stal
Basket GN 1/2; steel

Nr kat.	l cm	h cm	w cm	col	PLN	EUR
V-71202	31,5	8	25,5	czarny	80,92	-

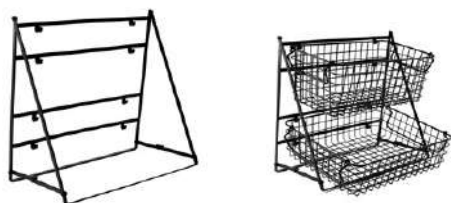

Stojak do koszyków GN 1/3; stal
Bakset display GN 1/3; steel

Nr kat.	l cm	h cm	w cm	col	PLN	EUR
V-71330	35	31	18	czarny	99,00	-

N



N

Kosz GN 1/3; stal
Basket GN 1/3; steel

Nr kat.	l cm	h cm	w cm	col	PLN	EUR	
V-71302	31,5	8	17	czarny	59,00	-	
V-71301	31,5	12	17	czarny	71,25	-	
V-71303	otwarty	31,5	12	17	czarny	71,25	-

Worek na pieczywo; bawełna
Bread bag; cotton

N

Nr kat.	→ □	l cm	h cm	w cm	PLN	EUR
V-368	V-71301	31,3	20,3	17,7	63,80	-
V-369	V-71303	31,5	20,3	17,7	63,80	-



Kosz na bagietki; stal
Bakery basket; steel

Nr kat.	l cm	h cm	w cm	col	PLN	EUR
V-72000	32,5	30	26,5	czarny	99,00	-

Worek na pieczywo; bawełna
Bread bag; cotton

Nr kat.	l cm	h cm	w cm	PLN	EUR
V-370	25,5	35,3	21	63,80	-

N

N





Wkładka termalna do toreb na pieczywo
Thermal insert for bread bags

Nr kat.	l cm	w cm	PLN	EUR
AB-305-002	12,5	12,5	19,62	-
AB-305-001	19,5	19,5	33,81	-

Utrzymuje temperaturę pieczywa
Thermal cushion for bread basket



Verlo



Sakwa na pieczywo; bawełna
Bread bag; cotton

Nr kat.	Ø cm	col	PLN	EUR
V-3017	30	ecru	162,50	-
V-4528	45	ecru	187,50	-



Verlo



Torba na pieczywo; bawełna
Bread bag; cotton

Nr kat.	l cm	w cm	col	PLN	EUR
V-1210	12,5	12,5	ecru	41,80	-
V-1220	12,5	12,5	brązowy	41,80	-
V-1910	19,5	19,5	ecru	47,04	-
V-1920	19,5	19,5	brązowy	47,04	-

Verlo



Torba na pieczywo, owoce; celuloza
Bread, fruit bag; cellulose

Nr kat.	Ø cm	h cm	col	PLN	EUR
V-6014	17,6	15	bązowy	32,35	-
V-6015	17,6	15	czarny	32,35	-
V-6016	17,6	15	szary	32,35	-





N

Koszyk GN 1/2; stal
Basket GN 1/2; steel

Nr kat.	l cm	h cm	w cm	col	PLN	EUR
V-32267	32,5	7,5	26,5	czarny	102,96	-



N

Koszyk GN 1/1; stal
Basket GN 1/1; steel

Nr kat.	l cm	h cm	w cm	col	PLN	EUR
V-53327	53	7,5	32,5	czarny	141,24	-



N

Koszyk owalny; stal
Oval basket; steel

Nr kat.	l cm	h cm	w cm	col	PLN	EUR
V-28167	28	7,5	16	czarny	65,34	-
V-34201	34	10	20	czarny	87,78	-



N

Koszyk prostokątny; stal
Rectangular basket; steel

Nr kat.	l cm	h cm	w cm	col	PLN	EUR
V-53167	53	7,5	16,2	czarny	112,20	-



Koszyk okrągły; stal
Round basket; steel

N

Nr kat.	Ø cm	h cm	col	PLN	EUR
V-15155-K	15	5	czarny	41,58	-
V-15155-BR	15	5	brązowy	41,58	-



Podgrzewacze bufetowe Verlo Verlo Buffet heaters

Wykonane z najwyższej jakości stali nierdzewnej. Posiadają stabilną konstrukcję, dno idealnie rozprowadzające ciepło i elegancki design, który perfekcyjnie wypełni bufetowe wnętrze.

Verlo Buffet heaters are made of the highest quality stainless steel. They have a stable structure, a bottom that distributes heat perfectly and an elegant design that will perfectly fill the buffet interior.

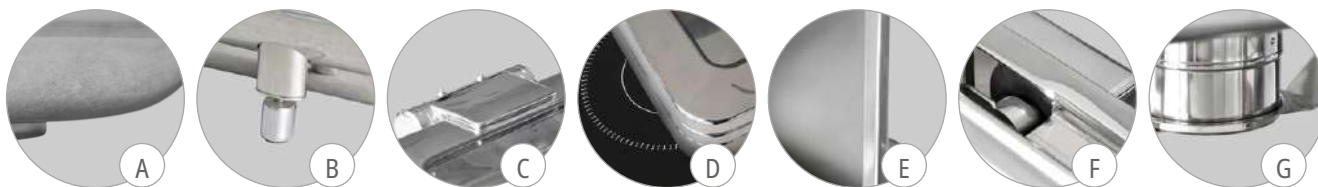

- A. Indukcyjne dno typu „sandwich”
- B. Wsuwany stabilizator zapobiegający ślizganiu
- C. Przeszklona pokrywa na zawiasach z olejowymi hamulcami
- D. Możliwość położenia bezpośrednio na płycie indukcyjnej
- E. Rynienka odprowadzająca skroploną parę wodną
- F. Hamulce cierne pokrywy
- G. Dostosowane do dwóch systemów podgrzewania: indukcyjnego i pastą T-7049-1 / T-7049-2

- A. „Sandwich” type induction bottom
- B. Pop-up anti-slip stabilizer
- C. Glass window hinged lid with oil brakes
- D. Can be placed directly on the induction hob
- E. A drain pan for condensed water vapor
- F. Friction brakes on the cover
- G. Adapted for two heating systems: electric and paste T-7049-1 / T-7049-2



Podgrzewacz indukcyjny GN 1/1; 18/10
Induction chafing dish; 18/10

Nr kat.		l cm	h cm	w cm	cap l	PLN	EUR
V-1150-72	podgrzewacz	57,5	18	46,6	9	2 738,60	-
V-1150-72B	podstawa	57,5	14,7	37		1 150,00	-

Podgrzewacz można postawić bezpośrednio na grzałce indukcyjnej, wbudowanej w blat • Zawias cierny • Możliwość ogrzewania grzałką lub pastą • Grubość wanny: 2 mm • W zestawie GN 1/1 • Łatwo demontowana przeszklona pokrywa • Pasująca grzałka: T-69131

The chafing dish can be placed directly on the induction heater, built into the worktop • Damping hinge • Can be heated with a heater or paste • Thickness of the bath: 2 mm • Included GN 1/1 • Easily removable glass cover • Matching heater: T-69131



Podgrzewacz indukcyjny GN 2/3; 18/10
Induction chafing dish; 18/10

Nr kat.		l cm	h cm	w cm	cap l	PLN	EUR
V-1150-74	podgrzewacz	46,5	16	40	6	2 251,92	-
V-1150-74B	podstawa	40	14,7	37		989,00	-

Podgrzewacz można postawić bezpośrednio na grzałce indukcyjnej, wbudowanej w blat • Zawias cierny • Możliwość ogrzewania grzałką lub pastą • Grubość wanny: 2 mm • W zestawie GN 2/3 • Łatwo demontowana przeszklona pokrywa • Pasująca grzałka: T-69131

The chafing dish can be placed directly on the induction heater, built into the worktop • Damping hinge • Can be heated with a heater or paste • Thickness of the bath: 2 mm • Included GN 2/3 • Easily removable glass cover • Matching heater: T-69131





Podgrzewacz indukcyjny GN 1/1; 18/10
Induction chafing dish; 18/10

Nr kat.		l cm	h cm	w cm	cap l	PLN	EUR
V-1160-72	podgrzewacz	57,5	18	46,6	9	3 898,00	-
V-1150-72B	podstawa	57,5	14,7	37		1 150,00	-

Podgrzewacz można postawić bezpośrednio na grzałce indukcyjnej, wbudowanej w blat • Hydrauliczny system hamujący opadanie pokrywy • Dwa dodatkowe uchwyty ułatwiające przenoszenie • Możliwość ogrzewania grzałką lub pastą • Grubość wanny: 2 mm • W zestawie GN 1/1 • Łatwo demontowana przeszklona pokrywa • Pasująca grzałka: T-69131

The chafingdish can be placed directly on the induction heater, built into the worktop • Hydraulic system for closing the lid • Two additional handles for easy handling • Can be heated with a heater or paste • Thickness of the bath: 2 mm • Included GN 1/1 • Easily removable glass cover • Matching heater: T-69131



Podgrzewacz indukcyjny GN 2/3; 18/10
Induction chafing dish; 18/10

Nr kat.		l cm	h cm	w cm	cap l	PLN	EUR
V-1160-74	podgrzewacz	46,5	16	40	6	3 198,00	-
V-1150-74B	podstawa	40	14,7	37		989,00	-

Podgrzewacz można postawić bezpośrednio na grzałce indukcyjnej, wbudowanej w blat • Hydrauliczny system hamujący opadanie pokrywy • Dwa dodatkowe uchwyty ułatwiające przenoszenie • Możliwość ogrzewania grzałką lub pastą • Grubość wanny: 2 mm • W zestawie GN 2/3 • Łatwo demontowana przeszklona pokrywa • Pasująca grzałka: T-69131

The chafingdish can be placed directly on the induction heater, built into the worktop • Hydraulic system for closing the lid • Two additional handles for easy handling • Can be heated with a heater or paste • Thickness of the bath: 2 mm • Included GN 2/3 • Easily removable glass cover • Matching heater: T-69131



PODGRZEWACZE INDUKCYJNE - SUPREME

Induction chafing dish - Supreme



Podgrzewacz indukcyjny GN 1/1; 18/10
Induction chafing dish GN 1/1; 18/10

Nr kat.		l cm	h cm	w cm	PLN	EUR
V-1110-72	podgrzewacz	57	16	46,5	3 689,93	-
V-1110-72H	podstawa	65,5	23	37,5	1 033,57	-
V-1110-72SZ	komplet				4 890,00	-

Podgrzewacz można postawić bezpośrednio na grzałce indukcyjnej, wbudowanej w blat • Hydrauliczny system hamujący opadanie pokrywy • Komplet: podgrzewacz V-1110-72, podstawa V-1110-72H, grzałka T-69131, wkład porcelanowy V-BUGN-11065-1

The chafingdish can be placed directly on the induction heater, built into the worktop • Hydraulic system for closing the lid



Komplet zawiera:



Podstawa indukcyjna pod podgrzewacz GN 2/3 i 1/1; Drewno dębowe
Induction chafing dish stand GN2/3 and 1/1; oak

Nr kat.	l cm	h cm	w cm	PLN	EUR
V-23100	50	14	40	1 017,66	-

Podstawa wykonana z litego drewna dębowego • nóżki wkręcane • kuchenka indukcyjna wbudowana wraz z regulacją mocy 1000W

The base is made of solid oak wood • screwed feet • built-in induction heater with power regulation 1000W





pojemnik porcelanowy
sprzedawany osobno
porcelain container
sold separately

Podgrzewacz indukcyjny GN 2/3; 18/10 Induction chafing dish; 18/10

Nr kat.		l cm	h cm	w cm	PLN	EUR
V-1110-74	podgrzewacz	35,4	16	32,5	3 005,87	-
V-1110-74H	podstawa	37,5	23	48,5	915,51	-

Podgrzewacz można postawić bezpośrednio na grzałce indukcyjnej, wbudowanej w blat • Hydrauliczny system hamujący opadanie pokrywy

The chafingdish can be placed directly on the induction heater, built into the worktop • Hydraulic system for closing the lid

ZESTAW – Podgrzewacz indukcyjny GN 2/3; 18/10 SET – Induction chafing dish; 18/10



Nr kat.		PLN	EUR
V-1110-74SZ	komplet	4 280,76	-

Podgrzewacz można postawić bezpośrednio na grzałce indukcyjnej, wbudowanej w blat • Hydrauliczny system hamujący opadanie pokrywy • Komplet: podgrzewacz V-1110-74, podstawa V-1110-74H, grzałka T-69131, wkład porcelanowy V-BUGN-23065-1

The chafing dish can be placed directly on the induction heater, built into the worktop • Hydraulic system for closing the lid • Set: heater V-1110-74, base V-1110-74H, heater T-69131, porcelain cartridge V-BUGN-23065-1



Podstawa indukcyjna pod podgrzewacz GN 2/3 i 1/1; Drewno dębowe Induction chafing dish stand GN2/3 and 1/1; oak

Nr kat.	l cm	h cm	w cm	PLN	EUR
V-23100	50	14	40	1 017,66	-

Podstawa wykonana z litego drewna dębowego • nóżki wkręcane • kuchenka indukcyjna wbudowana wraz z regulacją mocy 1000W

The base is made of solid oak wood • screwed feet • built-in induction heater with power regulation 1000W



Podgrzewacz indukcyjny do zupy; 18/10 Induction chafing dish for soup; 18/10

Nr kat.		l cm	h cm	w cm	cap l	PLN	EUR
V-1110-82	podgrzewacz	46	25	41,5	11	3 013,52	-
V-1110-82H	podstawa	38	18,5	38		795,09	-

Podgrzewacz można postawić bezpośrednio na grzałce indukcyjnej, wbudowanej w blat • Hydrauliczny system hamujący opadanie pokrywy • Zawiera garnek V-1110-82W w zestawie

The chafingdish can be placed directly on the induction heater, built into the worktop • Hydraulic system for closing the lid • Pot V-1110-82W included



Wkład do podgrzewacza V-1110-82; 18/10 Inset for V-1110-82 chafing dish; 18/10

Nr kat.	cap l	PLN	EUR
V-1110-82W	11	95,10	-
V-1110-82P	pokrywa	33,84	-



Urna do płynów; 18/10
Liquid urn; 18/10

Nr kat.	l cm	h cm	w cm	cap l	PLN	EUR
V-1120-038	36,4	46	36,4	12	1 481,38	-



Metalowy kranik
Metal tap

Grzałka do urny z adapterem; Al
Heating element for coffee urn with adapter; Al.

Nr kat.	Ø cm	W	PLN	EUR
AB-576-AD	14	80	920,00	-

Pasuje do urn: V-1120-038, V-1120-035
Matching to coffee urns: V-1120-038, V-1120-035



PODGRZEWACZE INDUKCYJNE - PRIME | Induction chafing dish - PRIME



Podgrzewacz indukcyjny GN 1/1; 18/10
Induction chafing dish; 18/10

Nr kat.	l cm	h cm	w cm	PLN	EUR
V-1110-72 podgrzewacz	57	16	46,5	3 689,93	-
V-1110-72K podstawa	59	17,5	38,5	1 025,54	-

Podgrzewacz można postawić bezpośrednio na grzałce indukcyjnej, wbudowanej w blat • Hydrauliczny system hamujący opadanie pokrywy

The chafingdish can be placed directly on the induction heater, built into the worktop • Hydraulic system for closing the lid

ZESTAW – Podgrzewacz indukcyjny GN 1/1; 18/10
SET Induction chafing dish GN 1/1

Nr kat.	PLN	EUR
V-1110-72PZ komplet	4 885,00	-

W skład zestawu wchodzi podgrzewacz V-1110-72, podstawa V-1110-72K, grzałka T-69131 oraz wkład porcelanowy V-BUGN-11065-1

The set includes a chafingdish V-1110-72, a base V-1110-72K, a heating element T-69131 and a porcelain GN container V-BUGN-11065-1



pojemnik porcelanowy
sprzedawany osobno
porcelain container
sold separately

Podgrzewacz indukcyjny GN 2/3; 18/10
Induction chafing dish; 18/10

Nr kat.	l cm	h cm	w cm	PLN	EUR
V-1110-74 podgrzewacz	35,4	16	32,5	3 005,87	-
V-1110-74K podstawa	38	17	42	908,96	-

Podgrzewacz można postawić bezpośrednio na grzałce indukcyjnej, wbudowanej w blat • Hydrauliczny system hamujący opadanie pokrywy

The chafingdish can be placed directly on the induction heater, built into the worktop • Hydraulic system for closing the lid

ZESTAW – Podgrzewacz indukcyjny GN 2/3; 18/10
SET – Induction chafing dish; 18/10

Nr kat.	PLN	EUR
V-1110-74PZ komplet	4 280,76	-

Podgrzewacz można postawić bezpośrednio na grzałce indukcyjnej, wbudowanej w blat • Hydrauliczny system hamujący opadanie pokrywy • Komplet: podgrzewacz V-1110-74, podstawa V-1110-74K, grzałka T-69131, wkład porcelanowy V-BUGN-23065-1

The chafing dish can be placed directly on the induction heater, built into the worktop • Hydraulic system for closing the lid • Set: heater V-1110-74, base V-1110-74K, heater T-69131, porcelain cartridge V-BUGN-23065-1





Podgrzewacz indukcyjny do zupy; 18/10
Induction chafing dish for soup; 18/10

Nr kat.		l cm	h cm	w cm	cap l	PLN	EUR
V-1110-82	podgrzewacz	46	25	41,5	11	3 013,52	-
V-1110-82K	podstawa	37,5	17	37,5		794,11	-

Podgrzewacz można postawić bezpośrednio na grzałce indukcyjnej, wbudowanej w blat
• Hydrauliczny system hamujący opadanie pokryw

The chafing dish can be placed directly on the induction heater, built into the worktop • Hydraulic system for closing the lid



Podgrzewacz; 18/10
Chafing dish; 18/10

pojemnik porcelanowy
sprzedawany osobno
porcelain container
sold separately

Nr kat.	l cm	h cm	w cm	cap l	PLN	EUR
V-1110-51	75	35	51	9	1 496,20	-

Pokrywa z czarnym systemem hamującym • Nienagrzewający się uchwyt pokrywy •
Możliwość sztaplowania • Specjalnie wyprofilowana pokrywa odprowadzająca skropliny do pojemnika beamarowego • Podgrzewacz nie zawiera pojemnika GN

Cover with frictional braking system • Cooling lid handle • Stackable • Specially profiled cover for drainage condensate to the bain marie container.



pojemnik porcelanowy
sprzedawany osobno
porcelain container
sold separately

Podgrzewacz do zupy; 18/10
Chafing dish; 18/10

Nr kat.	h cm	cap l	PLN	EUR
V-1110-53	35	9	1 262,17	-

Pokrywa z czarnym systemem hamującym • Nienagrzewający się uchwyt pokrywy •
Możliwość sztaplowania • Specjalnie wyprofilowana pokrywa odprowadzająca skropliny do pojemnika beamarowego • Podgrzewacz nie zawiera pojemnika GN

Cover with frictional braking system • Cooling lid handle • Stackable • Specially profiled cover for drainage condensate to the bain marie container • GN container not included



Wkład do podgrzewacza V-1110-82; 18/10
Inset for V-1110-82 chafing dish; 18/10

Nr kat.	cap l	PLN	EUR
V-1110-82W	11	95,10	-
V-1110-82P	pokrywa	33,84	-



AB-576-AD

Grzałka do urny
Heating element
for coffee urn

Urna do płynów; 18/10
Liquid urn; 18/10

Nr kat.	l cm	h cm	w cm	cap l	PLN	EUR
V-1120-035	35	49,5	30	12	860,42	-



Grzałka do urny z adapterem; Al
Heating element for coffee urn with adapter; Al

Nr kat.	Ø cm	W	PLN	EUR
AB-576-AD	14	80	920,00	-

Pasuje do urn: V-1120-038, V-1120-035

Matching to coffee urns: V-1120-038, V-1120-035



Podgrzewacz do zupy - ZESTAW
Soup chafing dish - SET

Nr kat.	PLN	EUR
V-1100-08DZ	2 064,00	-

W skład zestawu wchodzi podgrzewacz V-1110-53, nakładka V-1190-013, garnek V-1190-023 i grzałka V-7099-003

The set includes chafing dish V-1110-53, overlay V-1190-013, pot V-1190-023 and heating element V-7099-003

Zestaw zawiera:





Podgrzewacz indukcyjny BASIC GN 1/1; 18/10
Induction chafing dish MODERN GN 1/1; 18/10

Nr kat.		PLN	EUR
V-1130-72	podgrzewacz	2 163,60	-
V-1130-72K	podstawa (pasuje też do V-1100-81)	521,79	-
V-1130-72-AD	adapter	63,36	-

Pokrywa wolnoopadająca, zapobiegająca kapaniu na blat.
Slow-closing cover, preventing dripping onto the worktop



Podgrzewacz indukcyjny BASIC do zupy; 18/10
Soup induction chafing dish MODERN; 18/10

Nr kat.		cap l	PLN	EUR
V-1130-82	podgrzewacz	11	1 485,83	-
V-1130-82K	podstawa		456,09	-
V-1130-82-AD	adapter		63,36	-

Pokrywa wolnoopadająca, zapobiegająca kapaniu na blat.
Slow-closing cover, preventing dripping onto the worktop



Podgrzewacz indukcyjny BASIC GN1/1 BASIC; 18/10
Induction chafing dish GN 1/1 BASIC; 18/10

Nr kat.		l cm	h cm	w cm	PLN	EUR
V-1100-81	podgrzewacz	41	20	59	1 280,94	-
V-1100-81H	podstawa (pasuje też do V-1130-72)	38	24	58	393,22	-



Podstawa indukcyjna pod podgrzewacz GN 2/3 i 1/1; Drewno dębowe
Induction chafing dish stand GN2/3 and 1/1; oak

Nr kat.	l cm	h cm	w cm	PLN	EUR
V-23100	50	14	40	1 017,66	-

Podstawa wykonana z litego drewna dębowego • nóżki wkręcane • kuchenka indukcyjna wbudowana wraz z regulacją mocy 1000W
The base is made of solid oak wood • screwed feet • built-in induction heater with power regulation 1000W



Podgrzewacz Elite GN 1/1; 18/10
Chafing dish Elite; 18/10

Nr kat.	l cm	h cm	w cm	PLN	EUR
V-X32189	65	45	49	806,41	-

Pokrywa typu Roll-Top otwierana o 180° • W komplecie dwa pojemniki na pastę paliwową i pojemnik GN 1/1-65 • Wbudowane prowadnice do grzałki elektrycznej

Roll-Top cover opening 180° • Two fuel paste containers and GN 1/1-65 container included • Built-in guideways for electrical heater



Podgrzewacz Elite; 18/10
Chafing dish Elite; 18/10

Nr kat.	Ø cm	h cm	PLN	EUR
V-X32681	36	47	600,32	-

Pokrywa typu Roll-Top otwierana o 180° • W komplecie pojemnik na pastę paliwową i okrągły pojemnik GN

Roll-Top cover opening 180° • Complete with a fuel paste container and a round GN container





Podgrzewacz/Garnek bufetowy z szybą, czarny Warmer/Buffer pot with glass, black

Nr kat.	l cm	h cm	w cm	cap l	col	PLN	EUR
V-1104-01	42	16,8	40,5	4	czarny	1 396,56	-

Materiał: stal 18/10 • Podgrzewacz można postawić bezpośrednio na grzałce indukcyjnej, wbudowanej w blat • Możliwość ogrzewania pastą • Zawias czarny • W zestawie wkład o średnicy 28,5 cm • Przeszkłona pokrywa • Pasująca grzałka: T-69131

Material: 18/10 steel • The heater can be placed directly on the induction heater, built into the countertop • Paste heating possible • Friction hinge • 28.5 cm diameter insert included • Glass cover • Matching heater: T-69131



Podgrzewacz/Garnek bufetowy z szybą, miedziany Warmer/Buffer pot with glass, copper

Nr kat.	l cm	h cm	w cm	cap l	col	PLN	EUR
V-1104-02	42	16,8	40,5	4	miedziany	1 396,56	-

Materiał: stal 18/10 • Podgrzewacz można postawić bezpośrednio na grzałce indukcyjnej, wbudowanej w blat • Możliwość ogrzewania pastą • Zawias czarny • W zestawie wkład o średnicy 28,5 cm • Przeszkłona pokrywa • Pasująca grzałka: T-69132

Material: 18/10 steel • The heater can be placed directly on the induction heater, built into the countertop • Paste heating possible • Friction hinge • 28.5 cm diameter insert included • Glass cover • Matching heater: T-69132



Podstawa indukcyjna pod podgrzewacz; drewno dębowe Induction base for heater; oak wood

Nr kat.	Ø cm	h cm	PLN	EUR
V-22000	42	14	1 108,00	-

Wbudowana kuchenska indukcyjna o mocy 1000 W
Built-in 1000 watt induction stove





Pasują do nakładek:
Attachment fitting:

V-1190-021 — V-1190-011
V-1190-023 — V-1190-013

Garnek - soup station; 18/10
Pot - soup station; 18/14

Nr kat.	l cm	h cm	w cm	cap l	PLN	EUR
V-1190-021	29,5	22	24	4,5	257,99	-
V-1190-023	36	27	30	10	398,29	-



Wkład do podgrzewacza V-1110-82; 18/10
Inset for V-1110-82 chafing dish; 18/10

Nr kat.	cap l	PLN	EUR
V-1110-82W	11	95,10	-
V-1110-82P	pokrywa	33,84	-



Nakładka - soup station; 18/10
Soup station attachment; 18/10

Nr kat.	l cm	h cm	w cm	PLN	EUR
V-1190-013	39	3	39	234,16	-
V-1190-011	53,5	3	34	350,99	-



Grzałka / kuchenka indukcyjna
Induction heater

Nr kat.	l cm	h cm	w cm	W	kg	PLN	EUR
T-69032	35	6,5	30	2000	2,9	1 127,75	-
T-69332	30	4,5	37	2000	3,4	639,54	-



Grzałka / kuchenka indukcyjna
Induction heater

Nr kat.	Ø cm	h cm	W	PLN	EUR
T-69131	24	6,5	1000	407,55	-



Grzałka do urny z adapterem; Al
Heating element for coffee urn with adapter; Al.

Nr kat.	Ø cm	W	PLN	EUR
AB-576-AD	14	80	920,00	-



Grzałka elektryczna; Al
Heating element; Al.

Nr kat.	W	PLN	EUR
V-7099-3	500	399,00	-

Przewód dł. 2 m • Pasuje do okrągłych podgrzewaczy Supreme, Prime i Elite
Cable length 2 m • Fits round Supreme, Prime and Elite chafingdishes



Grzałka do podgrzewaczy; Al
Heater; Al.

Nr kat.	l cm	w cm	W	PLN	EUR
T-11802	25	20	700	342,47	-

Pasuje do podgrzewaczy GN 1/1 nieindukcyjnych Elite i Elite Basic
Matching to non-induction GN 1/1 Elite and Elite Basic chafingdishes



Naczynie na puszkę z paliwem; 18/10
Vessel for fuel; 18/10

Nr kat.	kg	PLN	EUR
T-15007	4	20,01	-



Pasta do podgrzewaczy
Fuel

Nr kat.	g	op.	PLN	EUR
T-7049-1	200	48	5,10	-

Etanol 50-80%, metanol < 3%, butan-2-on < 2% • Nie osmala naczyń • Bezzapachowa • Nietoksyczna - ekologiczna • Czas palenia: ok 3 godzin

Ethanol 50-80%, methanol < 3%, Butanone < 2% • Unscented • Non-toxic - ecological • Burning time: about 3 hours



Pasta do podgrzewaczy
Fuel

Nr kat.	kg	PLN	EUR
T-7049-4	4	69,00	-

Wysokiej jakości - czysty etanol • Nie osmala naczyń • Bezzapachowa • Nietoksyczna - ekologiczna

High quality - pure ethanol • Unscented • Non-toxic - ecological





 Podgrzewacz/Garnek bufetowy
Warmer/Buffer pot

Nr kat.	Ø cm	h cm	cap l	op.	PLN	EUR
○ RV-660129-1	19	11	1,3	1	893,40	-
● RV-660131-1	19	11	1,3	1	893,40	-



 Podgrzewacz/Garnek bufetowy
Warmer/Buffer pot

Nr kat.	Ø cm	h cm	cap l	op.	PLN	EUR
○ RV-660134-1	22	12,9	2,5	1	893,40	-
● RV-660136-1	22	12,9	2,5	1	972,02	-



 Podgrzewacz/Garnek bufetowy
Warmer/Buffer pot

Nr kat.	Ø cm	h cm	cap l	op.	PLN	EUR
○ RV-660138-1	26	15,2	4	1	1 051,22	-
● RV-660140-1	26	15,2	4	1	1 051,22	-



 Podgrzewacz/Garnek bufetowy
Warmer/Buffer pot

Nr kat.	Ø cm	h cm	cap l	op.	PLN	EUR
○ RV-660141-1	29	13,7	4	1	1 183,46	-
● RV-660142-1	29	13,7	4	1	1 183,46	-





N

 Podgrzewacz/Garnek bufetowy
 Warmer/Buffer pot

Nr kat.	Ø cm	h cm	cap l	op.	PLN	EUR
○ RV-660143-1	31	11,9	3,5	1	1 288,03	-
● RV-660144-1	31	11,9	3,5	1	1 288,03	-



N

 Podgrzewacz/Garnek bufetowy
 Warmer/Buffer pot

Nr kat.	Ø cm	h cm	cap l	op.	PLN	EUR
○ RV-660147-1	19	11,9	1,3	1	786,15	-
● RV-660148-1	19	11,9	1,3	1	786,15	-



N

 Podgrzewacz/Garnek bufetowy
 Warmer/Buffer pot

Nr kat.	Ø cm	h cm	cap l	op.	PLN	EUR
○ RV-660149-1	22	14,2	2,5	1	866,93	-
● RV-660150-1	22	14,2	2,5	1	866,93	-



N

 Podgrzewacz/Garnek bufetowy
 Warmer/Buffer pot

Nr kat.	Ø cm	h cm	cap l	op.	PLN	EUR
○ RV-660151-1	26	17	4	1	924,97	-
● RV-660152-1	26	17	4	1	924,97	-



N

 Podgrzewacz/Garnek bufetowy
 Warmer/Buffer pot

Nr kat.	Ø cm	h cm	cap l	op.	PLN	EUR
○ RV-660153-1	29	15,4	4	1	1 041,85	-
● RV-660154-1	29	15,4	4	1	1 041,85	-



N

 Naczynie/Brytfanna
 Dish/Oven pan

Nr kat.	l cm	h cm	w cm	cap l	op.	PLN	EUR
○ RV-660160-1	34	6,5	25	3,3	1	683,90	-
● RV-660162-1	34	6,5	25	3,3	1	683,90	-



N

 Wieszak na pokrywkę
 Hanger for lid

Nr kat.	l cm	h cm	w cm	op.	PLN	EUR
RV-656412-6	9	7,5	13,5	6	184,03	-



N

 Stojak na pokrywkę
 Stand for lid

Nr kat.	l cm	h cm	w cm	op.	PLN	EUR
RV-656398-2	23	36,5	35,5	2	420,73	-



N

 Podgrzewacz/Garnek z pokrywką Satin black
 Warmer/Cocotte with Satin black lid

Nr kat.	Ø cm	h cm	cap l	op.	PLN	EUR
RV-649816-1	22	14	2,4	1	997,12	-
RV-649855-1	26	14,5	3,4	1	1 072,27	-
RV-649863-1	28	13,5	3,6	1	1 278,39	-

N

 Podgrzewacz/Garnek z pokrywką Satin white
 Warmer/Cocotte with Satin white lid

Nr kat.	Ø cm	h cm	cap l	op.	PLN	EUR
RV-649818-1	22	14	2,4	1	997,12	-
RV-649856-1	26	14,5	3,4	1	1 072,27	-
RV-649864-1	28	13,5	3,6	1	1 278,39	-

N

 Podgrzewacz/Garnek ze szklaną pokrywką
 Warmer/Cocotte with glass lid

Nr kat.	Ø cm	h cm	cap l	op.	PLN	EUR
RV-649820-1	22	14	2,4	1	883,45	-
RV-649857-1	26	14,5	3,4	1	970,75	-
RV-649865-1	28	13,5	3,6	1	1 150,52	-

N

 Podgrzewacz/Garnek z pokrywką Cosmos Gold
 Warmer/Cocotte with Cosmos Gold lid

Nr kat.	Ø cm	h cm	cap l	op.	PLN	EUR
RV-653352-1	22	14	2,4	1	1 094,16	-
RV-653356-1	26	14,5	3,4	1	1 182,78	-
RV-653364-1	28	13,5	3,6	1	1 406,27	-

N

 Podgrzewacz/Garnek z pokrywką Silver
 Warmer/Cocotte with Silver lid

Nr kat.	Ø cm	h cm	cap l	op.	PLN	EUR
RV-653350-1	22	14	2,4	1	1 030,27	-
RV-653354-1	26	14,5	3,4	1	1 102,95	-
RV-653362-1	28	13,5	3,6	1	1 335,91	-

N

 Podgrzewacz/Garnek z pokrywką Touareg blue
 Warmer/Cocotte with Touareg blue lid

Nr kat.	Ø cm	h cm	cap l	op.	PLN	EUR
RV-649817-1	22	14	2,4	1	997,12	-
RV-649854-1	26	14,5	3,4	1	1 072,27	-
RV-649862-1	28	13,5	3,6	1	1 278,39	-



N

Podgrzewacz/Garnek owalny z pokrywką Satin black
Warmer/Cocotte oval with Satin black lid

Nr kat.	l cm	h cm	w cm	cap l	op.	PLN	EUR
● RV-649871-1	32,5	16	26,5	3,5	1	1 301,76	-
○ RV-649872-1	32,5	16	26,5	3,5	1	1 301,76	-
○ RV-649873-1	32,5	16	26,5	3,5	1	1 171,62	-
● RV-653370-1	32,5	16	26,5	3,5	1	1 431,95	-
● RV-653368-1	32,5	16	26,5	3,5	1	1 360,44	-
● RV-649870-1	32,5	16	26,5	3,5	1	1 301,76	-

N

Wkład porcelanowy
Porcelain insert

Nr kat.	Ø cm	h cm	cap l	op.	PLN	EUR
RV-646792-1	26,5	6,5	1,5	1	208,39	-

N

Wkład porcelanowy
Porcelain insert

Nr kat.	Ø cm	h cm	cap l	op.	PLN	EUR
RV-655111-1	28,1	6,7	2,5	1	211,76	-

N

Naczynie prostokątne
Rectangular dish

Nr kat.	l cm	h cm	w cm	cap l	op.	PLN	EUR
RV-645055-1	30,5	7	21,5	2,6	1	797,31	-

N

Naczynie prostokątne z pokrywką
Rectangular dish with lid

Nr kat.	l cm	h cm	w cm	cap l	op.	PLN	EUR
RV-655588-1	30,5	7	21,5	2,6	1	1 103,63	-





Verlo

Pojemnik GN 1/1; porcelana
Container GN 1/1; porcelain

Nr kat.	l cm	h cm	w cm	op.	PLN	EUR
V-BUGN-11022-2	53,5	2,2	33,5	2	306,35	-
V-BUGN-11065-1	53,5	6,5	33,5	1	306,35	-

Pojemnik dopasowany do skrzynki V-11006
Matching to V-11006



Verlo

Pojemnik GN 2/3; porcelana
Container GN 2/3; porcelain

Nr kat.	l cm	h cm	w cm	op.	PLN	EUR
V-BUGN-23022-3	32,5	2,2	35,4	3	162,47	-
V-BUGN-23065-1	32,5	6,5	35,4	1	162,47	-



Verlo

Pojemnik GN 1/3; porcelana
Container GN 1/3; porcelain

Nr kat.	l cm	h cm	w cm	op.	PLN	EUR
V-BUGN-13022-6	32,5	2,2	17	6	116,21	-
V-BUGN-13065-3	32,5	6,5	17	3	116,21	-



Pojemnik GN 1/1; porcelana
Container GN 1/1; porcelain

Nr kat.	l cm	h cm	w cm	op.	PLN	EUR
R-NFBU-11022BK-2	53	2,2	32,5	2	447,62	-
R-NFBU-11022GY-2	53	2,2	32,5	2	447,62	-
R-NFBU-11065WH-1	53	6,5	32,5	1	447,62	-
R-NFBU-11065BK-1	53	6,5	32,5	1	447,62	-



Verlo

Pojemnik GN 1/2; porcelana
Container GN 1/2; porcelain

Nr kat.	l cm	h cm	w cm	op.	PLN	EUR
V-BUGN-12022-3	33,5	2,2	26	3	161,34	-
V-BUGN-12065-2	33,5	6,5	26	2	161,34	-



Verlo

Pojemnik GN 2/4; porcelana
Container GN 2/4; porcelain

Nr kat.	l cm	h cm	w cm	op.	PLN	EUR
V-BUGN-24022-4	53,5	2,2	16,2	4	138,68	-
V-BUGN-24065-2	53,5	6,5	16,2	2	184,66	-



R-BUGN39-1



R-BUGN39D-1



R-BUGN20-2

Wkład; porcelana
Inset; porcelain

Nr kat.	Ø cm	h cm	cap l	op.	PLN	EUR
R-BUGN39-1	39	6,2	4,33	1	349,83	-
R-BUGN39D-1	39	6,2	4	1	368,64	-

Wkład do podgrzewaczy; porcelana
Insert for chafing dish; porcelain

Nr kat.	l cm	h cm	w cm	op.	PLN	EUR
R-BUGN20-2	39	6,5	19,5	2	195,60	-



Pojemnik GN 1/2; porcelana
Container GN 1/2; porcelain

Nr kat.	l cm	h cm	w cm	op.	PLN	EUR
R-NFBU-12022BK-3	32,5	2,2	26,5	3	235,72	-
R-NFBU-12022GY-3	32,5	2,2	26,5	3	235,72	-
R-NFBU-12065GY-2	32,5	6,5	26,5	2	235,72	-
R-NFBU-12065WH-2	32,5	6,5	26,5	2	235,72	-
R-NFBU-12065BK-2	32,5	26,5	26,5	2	235,72	-





Taca GN 1/1; melamina
Tray GN 1/1; melamine

Nr kat.	l cm	h cm	w cm	op.	PLN	EUR
V-11020M	53	2	32,5	12	86,70	-
N V-11020M-BK	53	2	32,5	12	84,79	-



Taca GN 1/2; melamina
Tray GN 1/2; melamine

Nr kat.	l cm	h cm	w cm	op.	PLN	EUR
V-12020M	32,5	2	26,5	24	45,15	-
N V-12020M-BK	32,5	2	26,5	24	44,18	-



Taca GN 1/3; melamina
Tray GN 1/3; melamine

Nr kat.	l cm	h cm	w cm	op.	PLN	EUR
V-13020M	32,5	2	17,6	24	42,60	-



Półmisek GN 1/1; melamina
Dish GN 1/1; melamine

Nr kat.	l cm	h cm	w cm	PLN	EUR
V-11030	52,8	3	32	138,75	-



Półmisek GN 1/2; melamina
Dish GN 1/2; melamine

Nr kat.	l cm	h cm	w cm	PLN	EUR
V-12030	32,5	3	26,5	72,75	-



Półmisek GN 1/3; melamina
Dish GN 1/3; melamine

Nr kat.	l cm	h cm	w cm	PLN	EUR
V-13030	32,5	3	17,6	55,35	-



Półmisek GN 1/4; melamina
Dish GN 1/4; melamine

Nr kat.	l cm	h cm	w cm	PLN	EUR
V-14030	26,5	3	16,2	40,50	-



Półmisek GN 2/4; melamina
Dish GN 2/4; melamine

Nr kat.	l cm	h cm	w cm	PLN	EUR
V-24030	53	3	16,2	69,30	-



Pojemnik GN 1/1; melamina
Container GN 1/1; melamine

Nr kat.	l cm	h cm	w cm	op.	PLN	EUR
V-11065M	53	6,5	32,5	6	173,25	-



Pojemnik GN 1/2; melamina
Container GN 1/2; melamine

Nr kat.	l cm	h cm	w cm	op.	PLN	EUR
V-12065M	32,5	6,5	26,5	12	90,00	-
V-12100M	32,5	10	26,5	12	110,25	-





Pojemnik GN 1/3; melamina
Container GN 1/3; melamine

Nr kat.	l cm	h cm	w cm	op.	PLN	EUR
V-13065M	32,5	6,5	17,6	12	65,85	-
V-13100M	32,5	10	17,6	12	89,25	-



Pojemnik GN 1/6; melamina
Container GN 1/6; melamine

Nr kat.	l cm	h cm	w cm	op.	PLN	EUR
V-16065M	17,6	6,5	16,2	24	51,30	-
V-16100M	17,6	10	16,2	12	62,85	-



Pokrywa GN 1/1; PC
Cover GN 1/1; PC

Nr kat.	l cm	h cm	w cm	PLN	EUR
V-61100-L	53	10	33	151,35	-



Pokrywa GN 1/2; PC
Cover GN 1/2; PC

Nr kat.	l cm	h cm	w cm	PLN	EUR
V-61200-L	32,5	10	27	81,75	-



Pokrywa roll top; PC
Cover roll top GN 1/1; PC

Nr kat.	h cm	PLN	EUR
V-61199	17	145,35	-



Termos z kranem; stal nierdzewna, poliuretan
Thermos with tap; stainless steel, polyurethane

Nr kat.	Ø cm	h cm	cap l	PLN	EUR
T-120-12	24	47	12	155,70	-

Blim[®]

Dzbanek; polipropylen
Jug; polypropylene



Nr kat.	Ø cm	h cm	cap l	col	PLN	EUR
○ BP-CF4-000	11	24	1,7	krystaliczny biały	80,49	-
● BP-CF4-010	11	24	1,7	karbon	80,49	-
● BP-CF4-314	11	24	1,7	leśny średni	80,49	-
● BP-CF4-319	11	24	1,7	mokka	80,49	-
● BP-CF4-335	11	24	1,7	morela	80,49	-
● BP-CF4-336	11	24	1,7	cukier trzcinyowy	80,49	-



Dyspenser do płatków; 18/10, SAN
Muesli dispenser; 18/10, SAN

Nr kat.	l cm	h cm	w cm	cap l	PLN	EUR
TF-84	35	68	50	2 x 8	1 710,00	-



Verlo

Dyspenser do soku; 18/10
Juice dispenser; 18/10

Nr kat.	l cm	h cm	w cm	cap l	PLN	EUR
V-2220-03	31	49	21	3	262,49	-

Tuba na lód
Ice insert



Dyspenser do musli; 18/10, SAN
Muesli dispenser; 18/10, SAN

Nr kat.	l cm	h cm	w cm	cap l	PLN	EUR
TF-01	22	52	17,5	4,5	414,00	-



Dyspenser do płatków; 18/10, SAN
Muesli dispenser; 18/10, SAN

Nr kat.	l cm	h cm	w cm	cap l	PLN	EUR
TF-02	22	52	35	2 x 4,5	745,00	-



N

Śłoik z klamrą, cylinder
Buckle jar, cylinder

Nr kat.	Ø cm	h cm	cap ml	op.	PLN	EUR
T-1125	7,8	9,9	250	4	33,06	-
T-1150	10	11,8	500	4	37,50	-
T-1170	10	14,5	750	4	41,52	-
T-1110	10	21	1000	4	48,00	-



N

Śłoik z klamrą, kwadrat
Buckle jar, square

Nr kat.	l cm	h cm	w cm	cap ml	op.	PLN	EUR
T-1350	11,5	10,3	11,5	500	4	37,44	-
T-1375	11,5	12,5	11,5	750	4	42,96	-
T-1310	11,5	15,2	11,5	1000	4	47,04	-
T-1315	11,5	20,2	11,5	1500	4	57,00	-

KUP ON-LINE





N

Deska owalna; dąb
Oval board; oak

Nr kat.	l cm	h cm	w cm	PLN	EUR
V-11551	30	4	15	113,01	-
V-11552	40	4	20	161,79	-
V-11553	50	4	29	324,39	-



N

Deska do serwowania; mango
Serving board; mango

Nr kat.	h cm	w cm	op.	PLN	EUR
V-D1007	2	38	1	112,50	-

Uchwyt ze stali nierdzewnej w kolorze różowego złota • impregnowana olejem bezbarwnym
Rose gold stainless steel handle • Impregnated with colorless oil



N

Deska do serwowania; mango
Serving board; mango

Nr kat.	l cm	h cm	w cm	op.	PLN	EUR
V-D1006	47,6	2	38	1	149,70	-

Dwa uchwyty ze stali nierdzewnej w kolorze różowego złota • impregnowana olejem bezbarwnym
Two rose gold stainless steel handles • Impregnated with colorless oil



N

Deska do serwowania akacja
Serving board; acacia

Nr kat.	l cm	h cm	w cm	op.	PLN	EUR
V-D1004	33	3	22,5	1	74,25	-
V-D1005	46	3	32	1	113,25	-

Skórzany uchwyt • impregnowana olejem bezbarwnym
Leather handle • impregnated with colorless oil

Deska z otworem; dąb
Board with a hole; oak

Nr kat.	l cm	h cm	w cm	PLN	EUR
V-11634	26	2,5	26	107,50	-

Deska okrągła z otworem; dąb
Round board with a hole; oak

Nr kat.	Ø cm	h cm	PLN	EUR
V-11547	28	2,5	182,75	-

Deska; dąb
Board; oak

Nr kat.	l cm	h cm	w cm	PLN	EUR
V-11518	26	2,5	16	65,63	-

Deska z otworem; dąb
Board with a hole; oak

Nr kat.	l cm	h cm	w cm	PLN	EUR
V-11635	38	2,5	23,5	117,60	-
V-11636	50	2,5	30	176,30	-

Deska z otworem; dąb
Board with a hole; oak

Nr kat.	l cm	h cm	w cm	PLN	EUR
V-11633	40	2,5	10	58,80	-





Deska do serwowania; dąb
Serving board; oak

Nr kat.	l cm	h cm	w cm	PLN	EUR
V-7015	70	2,5	15	144,38	-

Nieregularny kształt • Rozmiar może się różnić w zakresie +/- 2 cm
Irregular shape • Size may vary within +/- 2 cm



Deska; dąb
Board; oak

Nr kat.	l cm	h cm	w cm	PLN	EUR
V-11517	50	4	30	315,00	-



Deska prezentacyjna; dąb
Presentation board; oak

Nr kat.	l cm	h cm	w cm	PLN	EUR
V-11542	28	4	20	113,40	-



Deska prezentacyjna; dąb
Presentation board; oak

Nr kat.	l cm	h cm	w cm	PLN	EUR
V-11543	45	4	25	236,50	-



Deska prezentacyjna; dąb
Presentation board; oak

Nr kat.	l cm	h cm	w cm	PLN	EUR
V-11544	28	4	28	159,10	-



Deska prezentacyjna; dąb
Presentation board; oak

Nr kat.	l cm	h cm	w cm	PLN	EUR
V-11545	27	4	19,5	113,40	-



Deska prezentacyjna; dąb
Presentation board; oak

Nr kat.	l cm	h cm	w cm	PLN	EUR
V-11541	45	4	19,5	170,10	-



Deska prezentacyjna; dąb
Presentation board; oak

Nr kat.	l cm	h cm	w cm	PLN	EUR
V-11539	49	4	29	264,60	-

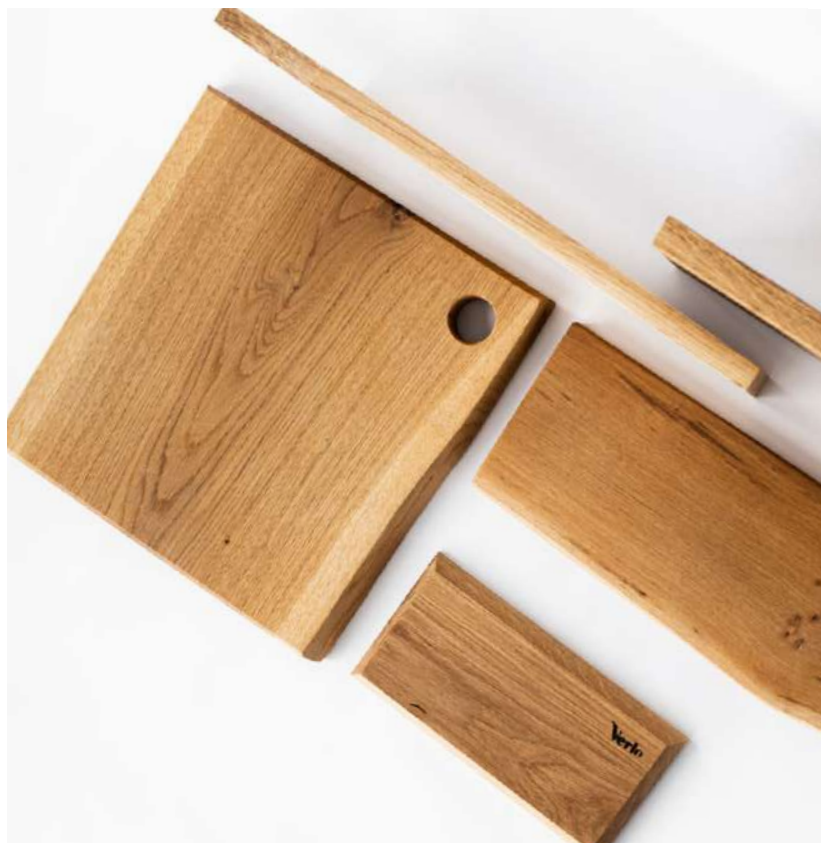

Deska; dąb
Board; oak

Nr kat.	l cm	h cm	w cm	PLN	EUR
V-11525	35	2,5	15,5	126,00	-

Deska; dąb
Board; oak

Nr kat.	l cm	h cm	w cm	PLN	EUR
V-11526	24	2,5	12	63,00	-

Deska do serwowania; dąb
Serving board; oak

Nr kat.	l cm	h cm	w cm	PLN	EUR
V-3015	30	2,5	15	65,63	-

Nieregularny kształt • Rozmiar może się różnić w zakresie +/- 2 cm
Irregular shape • Size may vary within +/- 2 cm

Deska do sushi
Sushi board

Nr kat.	l cm	w cm	op.	PLN	EUR
V-30058	20	12	1	14,11	-
V-30059	27,5	18	1	20,52	-

Deska do serwowania; dąb
Serving board; oak

Nr kat.	l cm	h cm	w cm	PLN	EUR
V-7015R	70	2,5	15	144,38	-

Nieregularny kształt • Rozmiar może się różnić w zakresie +/- 2 cm
Irregular shape • Size may vary within +/- 2 cm

Deska; dąb
Board; oak

Nr kat.	l cm	h cm	w cm	PLN	EUR
V-11521	50	2	10	105,00	-

Deska z otworami; dąb
Board with holes; oak

Nr kat.	Ø o cm	l cm	h cm	w cm	PLN	EUR
V-11519	7,3	50	2	10	105,00	-
V-11520	6,3	50	2	10	105,00	-





N

Talerz drewniany; mango
Wooden plate; mango

Nr kat.	Ø cm	h cm	op.	PLN	EUR
V-D1001	30	3,5	1	99,75	-

Impregnowany olejem bezbarwnym
Impregnated with colorless oil



N

Talerz drewniany; akacja
Wooden plate; acacia

Nr kat.	l cm	h cm	w cm	op.	PLN	EUR
V-D1002	29,7	2	19,7	1	60,75	-

Impregnowany olejem bezbarwnym
Impregnated with colorless oil



N

Talerz drewniany; akacja
Wooden plate; acacia

Nr kat.	l cm	h cm	w cm	op.	PLN	EUR
V-D1003	20	2	11	1	47,25	-

Impregnowany olejem bezbarwnym
Impregnated with colorless oil



N

Taca owalna; mango
Oval tray; mango

Nr kat.	l cm	h cm	w cm	op.	PLN	EUR
V-D1011	18	3,8	10	1	62,25	-

Impregnowany olejem bezbarwnym
Impregnated with colorless oil



Talerz drewniany
Wooden plate

Nr kat.	l cm	w cm	op.	PLN	EUR
V-30062	16	13	1	24,51	-



Talerz drewniany
Wooden plate

Nr kat.	l cm	w cm	op.	PLN	EUR
V-30063	20	20	1	39,33	-



Talerz drewniany
Wooden plate

Nr kat.	l cm	w cm	op.	PLN	EUR
V-30065	30	12,5	1	34,39	-



Talerz drewniany
Wooden plate

Nr kat.	l cm	w cm	op.	PLN	EUR
V-30064	30	20	1	58,90	-



Taca; dąb
Tray; oak

Nr kat.	l cm	h cm	w cm	PLN	EUR
V-11510	27	3	17	111,55	-

Taca; dąb
Tray; oak

Nr kat.	l cm	h cm	w cm	PLN	EUR
V-11511	29	3	23	153,22	-

Taca; dąb
Tray; oak

Nr kat.	l cm	h cm	w cm	PLN	EUR
V-11512	33	3	27	211,68	-

Taca; dąb
Tray; oak

Nr kat.	l cm	h cm	w cm	PLN	EUR
V-11513	22	3	13	85,68	-

Taca; dąb
Tray; oak

Nr kat.	l cm	h cm	w cm	PLN	EUR
V-11514	32	3	13	112,56	-

Taca; dąb
Tray; oak

Nr kat.	l cm	h cm	w cm	PLN	EUR
V-11515	53	3	22	277,20	-

Taca; dąb
Tray; oak

Nr kat.	l cm	h cm	w cm	PLN	EUR
V-11516	53	3	32	389,09	-





N

Taca; mango
Tray; mango

Nr kat.	l cm	h cm	w cm	op.	PLN	EUR
V-D1008	58	6	37	1	118,50	-

Lakierowana • dwa uchwyty
Lacquered • two handles



N

Taca; mango
Tray; mango

Nr kat.	l cm	h cm	w cm	op.	PLN	EUR
V-D1009	46	6	30	1	89,85	-

Lakierowana • dwa uchwyty
Lacquered • two handles



N

Taca; mango
Tray; mango

Nr kat.	l cm	h cm	w cm	op.	PLN	EUR
V-D1010	58	6	19	1	81,75	-

Lakierowana • dwa uchwyty
Lacquered • two handles



Taca kelnerska; Drewno dębowe
Service tray; oak

Nr kat.	l cm	h cm	w cm	PLN	EUR
V-60402	60	12	40	290,84	-

Taca dębowa serwisowa • lakierowana • bejcowana • kolor czarny
Oak service tray • varnished • stained • black colour



Taca kelnerska; Drewno dębowe
Service tray; oak

Nr kat.	l cm	h cm	w cm	PLN	EUR
V-60401	60	12	40	290,84	-

Taca dębowa serwisowa • lakierowana
Oak service tray • varnished



Taca; drewno
Tray; wood

Nr kat.	l cm	h cm	w cm	op.	PLN	EUR
RV-650745-4	40,7	2,5	30,6	4	238,48	-



N

Stojak do tac; drewno
Tray jack; wood

Nr kat.	l cm	h cm	PLN	EUR
V-ST8746	43	87	376,88	-

Łatwe rozkładanie • drewno dębowe lakierowane w kolorze czarnym.
Easy to unfold • black lacquered oak wood.





Panel GN; melamina
Panel GN; melamine



Nr kat.	l cm	h cm	w cm	col	PLN	EUR
V-61302	32,5	2	17,6	biały	58,62	-

Pasuje do podstawy MEZOS
Matching to MEZOS stand

Panel GN; melamina
Panel GN; melamine



Nr kat.	l cm	h cm	w cm	col	PLN	EUR
V-61304	32,5	2	17,6	czarny	61,99	-

Pasuje do podstawy MEZOS
Matching to MEZOS stand

Panel GN; melamina
Panel GN; melamine



Nr kat.	l cm	h cm	w cm	col	PLN	EUR
V-61303	32,5	2	17,6	czarny	58,62	-

Pasuje do podstawy MEZOS
Matching to MEZOS stand

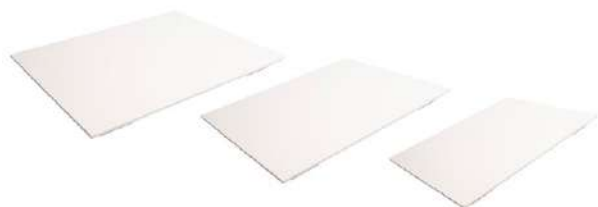

Panel GN; melamina
Panel GN; melamine



Nr kat.	l cm	h cm	w cm	col	PLN	EUR
V-61100	53	3	32,5	biały	136,76	-
V-61200	32,5	2	26,5	biały	80,51	-
V-61300	32,5	2	17,3	biały	52,33	-



nóżki antypoślizgowe
anti-slip feet

Talerz płaski; melamina
Flat plate; melamine

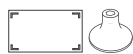

Nr kat.	Ø cm	col	PLN	EUR
V-63300	33	biały	87,31	-



pasuje do podstawy
V-1100; 1200; 1300,
V-63300
fits V-1100; 1200;
1300, V-63300

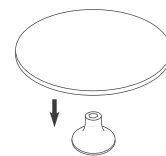

Podstawa; melamina
Base; melamine

Nr kat.	Ø cm	h cm	col	PLN	EUR
V-61301	15	9,5	biały	22,52	-

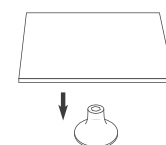



Taca bufetowa GN; melamina
Buffet tray GN; melamine

Nr kat.	l cm	h cm	w cm	col	PLN	EUR
V-1350-B	26,5	1,8	17,5	czarny	35,58	-



Taca Zen; melamina
Zen tray; melamine

Nr kat.	l cm	h cm	w cm	col	PLN	EUR
V-1351-B	30	2,3	22	czarny	45,79	-
V-1352-B	38,1	2,5	28,8	czarny	81,70	-



Blim®

Półmisek / taca; polipropylen
Platter / tray; polypropylene



Nr kat.	Ø cm	h cm	col	PLN	EUR
○ BP-VS5-000-L	40	3	krystaliczny biały	80,49	-
● BP-VS5-010-L	40	3	karbon	80,49	-
● BP-VS5-314-L	40	3	leśny średni	80,49	-
● BP-VS5-319-L	40	3	mokka	80,49	-
● BP-VS5-335-L	40	3	morela	80,49	-
● BP-VS5-336-L	40	3	cukier trzcinowy	80,49	-



Blim®

Półmisek / taca; polipropylen
Platter / tray; polypropylene



Nr kat.	Ø cm	h cm	col	PLN	EUR
○ BP-VS5-000-M	30	3	krystaliczny biały	56,10	-
● BP-VS5-010-M	30	3	karbon	56,10	-
● BP-VS5-314-M	30	3	leśny średni	56,10	-
● BP-VS5-319-M	30	3	mokka	56,10	-
● BP-VS5-335-M	30	3	morela	56,10	-
● BP-VS5-336-M	30	3	cukier trzcinowy	56,10	-



Blim®

Półmisek owalny
Oval platter



Nr kat.	l cm	h cm	w cm	col	PLN	EUR
○ BP-VS6-000-L	51	3	20,5	krystaliczny biały	80,49	-
● BP-VS6-010-L	51	3	20,5	karbon	80,49	-
● BP-VS6-314-L	51	3	20,5	leśny średni	80,49	-
● BP-VS6-319-L	51	3	20,5	mokka	80,49	-
● BP-VS6-335-L	51	3	20,5	morela	80,49	-
● BP-VS6-336-L	51	3	20,5	cukier trzcinowy	80,49	-



Blim®

Półmisek owalny
Oval platter



Nr kat.	l cm	h cm	w cm	col	PLN	EUR
○ BP-VS6-000-M	37,5	3	15	krystaliczny biały	52,85	-
● BP-VS6-010-M	37,5	3	15	karbon	52,85	-
● BP-VS6-314-M	37,5	3	15	leśny średni	52,85	-
● BP-VS6-319-M	37,5	3	15	mokka	52,85	-
● BP-VS6-335-M	37,5	3	15	morela	52,85	-
● BP-VS6-336-M	37,5	3	15	cukier trzcinowy	52,85	-



Blim[®]

N

Misa wysoka; polipropylen
High bowl; polypropylene

Nr kat.	Ø cm	h cm	col	PLN	EUR
○ BP-CI50-000-XL	30	12	krystaliczny biały	80,49	-
● BP-CI50-010-XL	30	12	karbon	80,49	-
● BP-CI50-314-XL	30	12	leśny średni	80,49	-
● BP-CI50-319-XL	30	12	mokka	80,49	-
● BP-CI50-335-XL	30	12	morela	80,49	-
● BP-CI50-336-XL	30	12	cukier trzcinowy	80,49	-

Blim[®]

N

Misa wysoka; polipropylen
High bowl; polypropylene

Nr kat.	Ø cm	h cm	col	PLN	EUR
○ BP-CI50-000-L	25	12	krystaliczny biały	56,10	-
● BP-CI50-010-L	25	12	karbon	56,10	-
● BP-CI50-314-L	25	12	leśny średni	56,10	-
● BP-CI50-319-L	25	12	mokka	56,10	-
● BP-CI50-335-L	25	12	morela	56,10	-
● BP-CI50-336-L	25	12	cukier trzcinowy	56,10	-



Blim[®]



Misa; polipropylen
Bowl; polypropylene

Nr kat.	Ø cm	h cm	col	PLN	EUR
○ BP-CI51-000-L	25	6	krystaliczny biały	52,85	-
● BP-CI51-010-L	25	6	karbon	52,85	-
● BP-CI51-314-L	25	6	leśny średni	52,85	-
● BP-CI51-319-L	25	6	mokka	52,85	-
● BP-CI51-335-L	25	6	morela	52,85	-
● BP-CI51-336-L	25	6	cukier trzcinowy	52,85	-

Blim[®]



Misa; polipropylen
Bowl; polypropylene

Nr kat.	Ø cm	h cm	col	PLN	EUR
○ BP-CI51-000-M	20	6	krystaliczny biały	39,84	-
● BP-CI51-010-M	20	6	karbon	39,84	-
● BP-CI51-314-M	20	6	leśny średni	39,84	-
● BP-CI51-319-M	20	6	mokka	39,84	-
● BP-CI51-335-M	20	6	morela	39,84	-
● BP-CI51-336-M	20	6	cukier trzcinowy	39,84	-

Blim[®]



Misa; polipropylen
Bowl; polypropylene

Nr kat.	Ø cm	h cm	col	PLN	EUR
○ BP-CI51-000-S	15	6	krystaliczny biały	31,71	-
● BP-CI51-010-S	15	6	karbon	31,71	-
● BP-CI51-314-S	15	6	leśny średni	31,71	-
● BP-CI51-319-S	15	6	mokka	31,71	-
● BP-CI51-335-S	15	6	morela	31,71	-
● BP-CI51-336-S	15	6	cukier trzcinowy	31,71	-

Blim[®]



Misa; polipropylen
Bowl; polypropylene

Nr kat.	Ø cm	h cm	col	PLN	EUR
○ BP-CI51-000-XS	11	6	krystaliczny biały	28,46	-
● BP-CI51-010-XS	11	6	karbon	28,46	-
● BP-CI51-314-XS	11	6	leśny średni	28,46	-
● BP-CI51-319-XS	11	6	mokka	28,46	-
● BP-CI51-335-XS	11	6	morela	28,46	-
● BP-CI51-336-XS	11	6	cukier trzcinowy	28,46	-

KUP ON-LINE





N

Półmisek; melamina
Dish; melamine

Nr kat.	l cm	h cm	w cm	col	PLN	EUR
V-2208	21,6	4,5	11,2	beżowy	16,20	-



N

Miska owalna; melamina
Oval bowl; melamine

Nr kat.	l cm	h cm	w cm	col	PLN	EUR
V-2207	17,9	6,3	13,3	beżowy	15,00	-



N

Miska owalna; melamina
Oval bowl; melamine

Nr kat.	l cm	h cm	w cm	cap l	col	PLN	EUR
V-2214	26,5	13,2	16,2	1,8	beżowy	84,60	-
V-2212	32,5	18	26,5	4,9	beżowy	174,60	-



N

Miska; melamina
Bowl; melamine

Nr kat.	Ø cm	h cm	cap l	col	PLN	EUR
V-2285	22,5	7	1,76	beżowy	40,35	-
V-2261	29	10	4,2	beżowy	65,25	-



N

Miska niska; melamina
Bowl low; melamine

Nr kat.	Ø cm	h cm	cap l	col	PLN	EUR
V-2262-CH	35	7	4,3	beżowy	74,10	-
V-2262-P	35	7	4,6	brudny róż	74,10	-

Możliwość zamontowania podstawy V-5304-CH; V-5304-P; V-5207-CH; V-5207-P

Possibility to mount base V-5304-CH; V-5304-P; V-5207-CH; V-5207-P



N

Podstawa; melamina
Stand; melamine

Nr kat.	h cm	col	PLN	EUR
V-5304-CH	10	beżowy	36,45	-
V-5304-P	10	brudny róż	36,45	-

Antypoślizgowe nóżki • łatwy montaż i demontaż • pasuje do miski niskiej V-2262-P i V-2262-CH oraz patery V-4112-P i V-4112-PCH

Non-slip feet • easy installation and removal • fits V-2262-P and V-2262-CH low bowl and V-4112-P and V-4112-PCH platter.





Podstawa; melamina
Stand; melamine

Nr kat.	h cm	col	PLN	EUR
V-5207-CH	18	beżowy	49,80	-
V-5207-P	18	brudny róż	49,80	-

Antypoślizgowe nóżki • łatwy montaż i demontaż • pasuje do misy niskiej V-2262-P i V-2262-CH oraz patery V-4112-P i V-4112-PCH

Non-slip feet • easy installation and removal • fits V-2262-P and V-2262-CH low bowl and V-4112-P and V-4112-PCH platter.



Patera; melamina
Plateau; melamine

Nr kat.	Ø cm	col	PLN	EUR
V-4112-CH	33	beżowy	64,05	-
V-4112-P	33	brudny róż	64,05	-

Możliwość zamontowania podstawy V-5304-CH; V-5304-P; V-5207-CH; V-5207-P

Possibility to mount base V-5304-CH; V-5304-P; V-5207-CH; V-5207-P



Miska; melamina
Bowl; melamine

Nr kat.	h cm	w cm	cap l	op.	PLN	EUR
V-6005	6,5	13	0,6	6	13,97	-
V-6006	8,4	15	1	1	27,39	-
V-6007	10	19	2,35	1	38,90	-
V-6008	10,5	27	4,15	1	69,28	-



Misa; melamina
Bowl; melamine

Nr kat.	Ø cm	h cm	PLN	EUR
V-6001	20	9,5	29,00	-
V-6002	28	12,5	51,00	-



Słoik z klamrą, cylinder
Buckle jar, cylinder

Nr kat.	Ø cm	h cm	cap ml	op.	PLN	EUR
T-1125	7,8	9,9	250	4	33,06	-
T-1150	10	11,8	500	4	37,50	-
T-1170	10	14,5	750	4	41,52	-
T-1110	10	21	1000	4	48,00	-



Słoik z klamrą, kwadrat
Buckle jar, square

Nr kat.	l cm	h cm	w cm	cap ml	op.	PLN	EUR
T-1350	11,5	10,3	11,5	500	4	37,44	-
T-1375	11,5	12,5	11,5	750	4	42,96	-
T-1310	11,5	15,2	11,5	1000	4	47,04	-
T-1315	11,5	20,2	11,5	1500	4	57,00	-



FIRE

Misa
Bowl

Nr kat.	Ø cm	cap ml	op.	PLN	EUR
V-83001-1	30,5	2600	1	142,69	-

Talerz płaski
Flat plate

Nr kat.	l cm	w cm	op.	PLN	EUR
V-83002-4	33	18	4	49,38	-



METRO

Miska
Bowl

Nr kat.	Ø cm	cap ml	op.	PLN	EUR
V-84000-3	20	1800	3	51,73	-
V-84002-3	25,5	3400	3	75,81	-

Miska
Bowl

Nr kat.	Ø cm	cap ml	op.	PLN	EUR
V-84001-3	20	1800	3	39,84	-
V-84003-3	25,5	3400	3	60,16	-





Talerz głęboki
Deep plate

Nr kat.	Ø cm	cap ml	op.	PLN	EUR
V-82006-4	23,5	1200	4	56,36	-



Talerz głęboki
Deep plate

Nr kat.	Ø cm	cap ml	op.	PLN	EUR
V-82007-2	26	1500	2	68,66	-



Misa bufetowa
Buffet bowl

Nr kat.	Ø cm	cap ml	op.	PLN	EUR
V-82000-2	25	600	2	90,63	-
V-82001-1	30,5	1700	1	157,13	-



Miska
Bowl

Nr kat.	Ø cm	cap ml	op.	PLN	EUR
V-82005-4	18	800	4	36,34	-



Misa
Bowl

Nr kat.	Ø cm	cap ml	op.	PLN	EUR
V-82003-1	29,5	2100	1	84,55	-
V-82004-1	34	3800	1	151,62	-



Misa
Bowl

Nr kat.	Ø cm	cap ml	op.	PLN	EUR
V-82002-2	24,5	1600	2	58,33	-



Półmisek
Rectangular dish

Nr kat.	l cm	w cm	op.	PLN	EUR
V-82010-6	30,5	14	6	56,43	-
V-82011-4	35,5	16,5	4	72,58	-



BET-ON

Miska
Bowl

Nr kat.	Ø cm	cap ml	op.	PLN	EUR
V-86003-4	16,5	900	4	24,94	-

TIME

Misa
Bowl

Nr kat.	Ø cm	cap ml	op.	PLN	EUR
V-80003-1	22	2800	1	97,28	-

CANE

Misa
Bowl

Nr kat.	Ø cm	cap ml	op.	PLN	EUR
V-81001-6	15,5	630	6	33,56	-
V-81002-6	20	1400	6	55,36	-



ZELI

Talerz płaski
Flat plate

Nr kat.	l cm	w cm	op.	PLN	EUR
V-87002-2	39	31	2	66,26	-

Misa bufetowa
Buffet bowl

Nr kat.	Ø cm	cap ml	op.	PLN	EUR
V-87000-2	26,5	3100	2	94,05	-



Talerz płaski
Flat plate

Nr kat.	l cm	w cm	op.	PLN	EUR
RV-641004-6	25	25	6	127,40	-
RV-641007-6	20	20	6	92,57	-
RV-641913-3	30	30	3	206,37	-

Talerz bufetowy GN 2/4
Buffet plate GN 2/4

Nr kat.	l cm	w cm	op.	PLN	EUR
RV-644986-2	54	16,5	2	232,45	-

Talerz płaski
Flat plate

Nr kat.	Ø cm	op.	PLN	EUR
RV-647911-2	30	2	149,01	-



Więcej elementów z kolekcji BASALT na str. 436–438

See more products from BASALT collection on pages 436–438
CLUB

Półmisek
Dish

Nr kat.	l cm	w cm	op.	PLN	EUR
RV-650387-4	48	21	4	265,00	-

Talerz płaski
Flat plate

Nr kat.	l cm	w cm	op.	PLN	EUR
RV-647932-6	26	26	6	154,03	-

Talerz płaski
Flat plate

Nr kat.	l cm	w cm	op.	PLN	EUR
RV-646321-4	36	21	4	168,43	-

Naczynie
Dish

Nr kat.	l cm	w cm	op.	PLN	EUR
RV-647928-2	33	8	2	121,22	-

Talerz płaski
Flat plate

Nr kat.	l cm	w cm	op.	PLN	EUR
RV-646319-4	36	15	4	147,46	-

Talerz płaski
Flat plate

Nr kat.	l cm	w cm	op.	PLN	EUR
RV-646118-4	32	21	4	127,78	-





Miska
Bowl

Nr kat.	Ø cm	cap ml	op.	PLN	EUR
RV-642496-4	17	700	4	79,17	-



Miska
Bowl

Nr kat.	Ø cm	cap ml	op.	PLN	EUR
RV-642035-6	10	250	6	50,74	-



Waza; porcelana
Vase; porcelain

Nr kat.	Ø cm	cap l	op.	PLN	EUR
R-ANS23-1	23	2,4	1	80,24	-
R-ANS26-1	26	3	1	100,31	-



Waza do zupy; porcelana
Vase; porcelain

Nr kat.	Ø cm	cap l	op.	PLN	EUR
R-BUST27-1	27	3,5	1	346,06	-



Podstawka pod łyżkę; porcelana
Spoon holder; porcelain

Nr kat.	l cm	h cm	w cm	op.	PLN	EUR
RV-644293-3	19,7	3,8	10,4	3	96,67	-

Brak łyżki w zestawie
Spoon is not included



Podstawka pod sztućce porcelana
Cutlery holder; porcelain

Nr kat.	l cm	w cm	op.	PLN	EUR
R-CLRP29-12	29	12	12	66,45	-

Brak łyżki w zestawie
Spoon is not included



Półmisek; porcelana
Buffet dish; porcelain

Nr kat.	l cm	w cm	op.	PLN	EUR
R-LXBS30-4	30	12	4	300,93	-



Półmisek; porcelana
Buffet dish; porcelain

Nr kat.	l cm	w cm	op.	PLN	EUR
R-LXBS51-4	51	30	4	436,34	-

Verlo



Miska; porcelana
Bowl; porcelain

Nr kat.	Ø cm	cap l	op.	PLN	EUR
V-BUBC30-6	30	1,9	6	62,21	-

Verlo



Misa bufetowa; porcelana
Buffet bowl; porcelain

Nr kat.	l cm	w cm	cap ml	op.	PLN	EUR
V-BUBS21-1	21	21	2000	1	105,07	-
V-BUBS23-1	23	23	3000	1	125,84	-
V-BUBS25-1	25	25	4160	1	165,68	-



Miska sztaplowalna
Stackable bowl



Nr kat.	Ø cm	cap l	op.	PLN	EUR
R-BASB12-12	12	0,25	12	18,81	-
R-BASB16-12	16	0,6	12	21,32	-
R-BASB18-12	18	0,72	12	36,37	-
R-BASB21-12	21	1,18	12	47,65	-



KUP ON-LINE



Miska; porcelana
Bowl; porcelain

Nr kat.	l cm	h cm	w cm	cap l	op.	PLN	EUR
R-CLSB12-12	12	4,5	12	0,2	12	23,83	-
R-CLSB14-12	14	4,5	14	0,32	12	28,84	-
R-CLSB16-12	16	4,5	16	0,4	12	36,37	-
R-CLSB18-12	18	4,5	18	0,45	12	42,63	-
R-CLSB21-6	21	4,5	21	0,65	6	56,43	-



Miska; porcelana
Bowl; porcelain

Nr kat.	Ø cm	cap l	op.	PLN	EUR
V-BUBC26-12	26	1,2	12	46,07	-
V-BUBC30-6	30	1,9	6	62,21	-
R-BUBC36-1	36	3,6	1	241,99	-
R-BUBC46-1	46	5,75	1	317,22	-



Miska; porcelana
Bowl; porcelain

Nr kat.	Ø cm	cap l	op.	PLN	EUR
R-NNBW20-6	20	0,9	6	25,07	-



Miska; porcelana
Bowl; porcelain

Nr kat.	l cm	w cm	cap l	op.	PLN	EUR
R-FDBO16-6	16	11	0,32	6	35,11	-
R-FDBO24-6	23,5	15,3	1,11	6	77,74	-
R-FDBO27-6	27	19	1,07	6	94,04	-



Miska; porcelana
Bowl; porcelain

Nr kat.	l cm	w cm	cap l	op.	PLN	EUR
R-MNDB116-6	23	13	1,16	6	33,85	-



Miska; porcelana
Bowl; porcelain

Nr kat.	l cm	w cm	cap l	op.	PLN	EUR
R-MNSB32-6	17	10,5	0,32	6	20,06	-
R-MNSB34-6	21	12	0,34	6	33,85	-
R-MNSB44-6	23	13	0,44	6	37,61	-



Verlo

Misa bufetowa; porcelana
Buffet bowl; porcelain

Nr kat.	Ø cm	h cm	w cm	cap l	op.	PLN	EUR
V-BUBA22-1	21,5	9	22	0,65	1	149,26	-
V-BUBA29-1	29	14	29	1,6	1	242,62	-



Verlo

Miska
Bowl

Nr kat.	Ø cm	cap l	op.	PLN	EUR
V-BASP16-12	16	0,67	12	21,43	-
V-BASP20-12	20	1,05	12	48,52	-
V-BASP25-1	25	2	1	54,38	-
V-BASP31-1	31	5,9	1	92,99	-





Talerz płaski
Flat plate

Nr kat.	l cm	w cm	op.	PLN	EUR
R-EDSQ25IV-12	25	25	12	43,89	-
R-EDSQ27IV-12	27	27	12	57,67	-



Półmisek; porcelana
Buffet dish; porcelain

Nr kat.	l cm	w cm	op.	PLN	EUR
R-OPRP6C-6	28	20	6	123,01	-



Talerz płaski
Flat plate

Nr kat.	l cm	w cm	op.	PLN	EUR
R-OPSP4C-12	20	20	12	101,56	-



Talerz płaski
Flat plate

Nr kat.	l cm	w cm	op.	PLN	EUR
R-EDRG33IV-12	33,5	18	12	47,65	-



Półmisek głęboki; porcelana
Deep buffet dish; porcelain

Nr kat.	l cm	h cm	w cm	PLN	EUR
R-LXRB47-1	47	6	20	204,38	-



Talerz płaski
Flat plate

Nr kat.	l cm	w cm	op.	PLN	EUR
R-CLRP21-12	21	7	12	46,39	-
R-CLRP23-12	23	7	12	50,16	-
R-CLRP26-12	26	8	12	61,44	-
R-CLRP29-12	29	12	12	66,45	-
R-CLRP33-6	33	23	6	70,22	-
R-CLRP38-6	38	21	6	94,04	-



Półmisek
Dish

Nr kat.	l cm	w cm	op.	PLN	EUR
R-BAOP22-12	22	15	12	28,84	-
R-BAOP26-12	26	18	12	37,61	-
R-BAOP32-6	32	22	6	51,40	-
R-BAOP38-6	38	26	6	60,18	-
R-BAOP45-4	45	33	4	89,02	-



Podkładka na sztućce serwisowe
Spoon holder; porcelain

Nr kat.	l cm	w cm	op.	PLN	EUR
R-ACDS01-6	35,5	18,5	6	82,01	-



Talerz płaski
Flat plate

Nr kat.	l cm	w cm	op.	PLN	EUR
R-CLSP24-12	24	24	12	52,66	-
R-CLSP27-12	27	27	12	58,93	-



Półmisek; porcelana
Buffet dish; porcelain

Nr kat.	l cm	w cm	op.	PLN	EUR
R-BURT41-6	41	30	6	179,31	-



Półmisek bufetowy; porcelana
Dish; porcelain

Nr kat.	l cm	w cm	op.	PLN	EUR
V-BURT52-6	52	24	6	231,01	-

Verlo



Ekspozytor; akryl
Display; acrylic

Nr kat.		l cm	h cm	w cm	PLN	EUR
FF-7036B	szer. półki 6 cm	70	37	36	514,00	-
FF-7036T	szer. półki 6 cm	70	37	36	476,00	-

Ekspozytor; akryl
Display; acrylic

Nr kat.		l cm	h cm	w cm	PLN	EUR
FF-3636B	szer. półki 6 cm	36	37	36	362,00	-
FF-3636T	szer. półki 6 cm	36	37	36	327,27	-



Ekspozytor; akryl
Display; acrylic

Nr kat.	Ø cm	h cm	PLN	EUR
FF-0047B	47	23	460,00	-

Ekspozytor; akryl
Display; acrylic

Nr kat.	l cm	w cm	PLN	EUR
FF-4747B	47	47	540,00	-

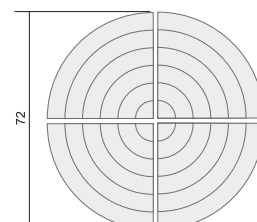
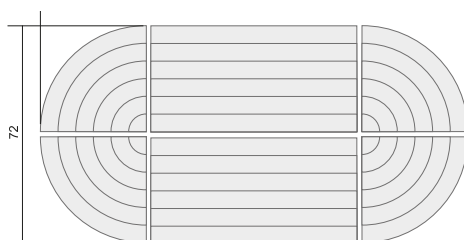
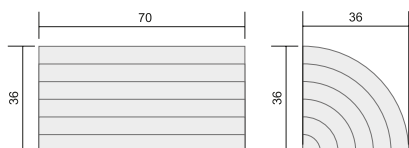



Ekspozytor; plexiglass
Display; plexiglass

Nr kat.	l cm	h cm	w cm	PLN	EUR
V-7001	19,5	18	40	150,00	-

Ekspozytor; plexiglass
Display; plexiglass

Nr kat.	l cm	h cm	w cm	PLN	EUR
V-7002	23	23	53	212,00	-

KUP ON-LINE 



Naczynie; PET
Dish; PET

Nr kat.	Ø cm	h cm	cap ml	col	op.	PLN	EUR
V-6017	6	3,5	45	przezroczysty	12	2,42	-
V-6018	7	3,5	60	przezroczysty	12	2,99	-
V-6019	6	3,5	45	biały	12	2,42	-
V-6020	7	3,5	60	biały	12	2,99	-
V-6021	6	3,5	45	czarny	12	2,42	-
V-6022	7	3,5	60	czarny	12	2,99	-



Miseczka; melamina
Bowl; melamine

Nr kat.	l cm	h cm	w cm	op.	PLN	EUR
V-6004	7	4,2	7	12	7,13	-



Miseczka; melamina
Bowl; melamine

Nr kat.	l cm	h cm	w cm	op.	PLN	EUR
V-6010	10,4	2,5	4,8	24	3,44	-



Miseczka; melamina
Bowl; melamine

Nr kat.	Ø cm	h cm	op.	PLN	EUR
V-6003	7	6	12	4,94	-



Miseczka; melamina
Bowl; melamine

Nr kat.	l cm	h cm	w cm	op.	PLN	EUR
V-6011	9,1	3,2	6,3	12	4,79	-



Łyżeczka azjatycka; melamina
Asian spoon; melamine

Nr kat.	l cm	h cm	w cm	PLN	EUR
TF-842	10,8	4	4,3	6,65	-
TF-843	10,8	4	4,3	6,65	-



Miseczka; melamina
Bowl; melamine

Nr kat.	l cm	h cm	w cm	col	op.	PLN	EUR
V-6009	10	5	8	biały	24	3,70	-



Talerzyk; melamina
Plate; melamine

Nr kat.	w cm	col	op.	PLN	EUR
V-6013	10	biały	24	4,67	-



Widelczyk do tapas; 18/10
Fork for tapas; 18/10

Nr kat.	l cm	thk mm	op.	PLN	EUR
E-104192-12	9,8	1,2	12	20,99	-



Naczynie Fringerfood
Fingerfood dish

Nr kat.	l cm	w cm	op.	PLN	EUR
V-30042	6	6	50	27,36	-
V-30043	8	8	50	34,34	-
V-30044	10	10	50	42,47	-



Łódka Fingerfood
Wooden boat

Nr kat.	l cm	w cm	op.	PLN	EUR
V-30037	8	5,5	50	10,69	-
V-30038	11,5	6,5	50	10,69	-
V-30039	14	7,5	50	14,96	-
V-30040	16,5	9	50	18,67	-
V-30041	20,5	10	50	24,65	-



Miseczka Fingerfood
Fingerfood bowl

Nr kat.	Ø cm	op.	PLN	EUR
V-30045	8,5	50	52,87	-



Rożek drewniany
Wooden cone

Nr kat.	Ø cm	h cm	op.	PLN	EUR
V-30033	3	8,5	50	10,26	-
V-30034	4,5	12,5	50	13,68	-
V-30035	6	16,5	50	18,38	-
V-30036	7,5	19,5	50	23,37	-



Rożek Fingerfood
Fingerfood cone

Nr kat.	Ø cm	h cm	op.	PLN	EUR
V-30048	3,5	8,5	50	16,96	-
V-30049	5	12,5	50	29,93	-
V-30050	8	20	50	55,72	-



Miseczka Fingerfood
Fingerfood bowl

Nr kat.	Ø cm	op.	PLN	EUR
V-30046	8,5	50	55,43	-



Kubeczek Fingerfood
Fingerfood cup

Nr kat.	Ø cm	h cm	op.	PLN	EUR
V-30032	5,5	7	25	13,61	-



Kubeczek Fingerfood
Fingerfood cup

Nr kat.	Ø cm	h cm	op.	PLN	EUR
V-30030	4,5	4,5	50	25,37	-



Kubeczek Fingerfood
Fingerfood cup

Nr kat.	Ø cm	h cm	op.	PLN	EUR
V-30031	6	6	50	27,93	-



Naczynie bambusowe
Bamboo dish

Nr kat.	l cm	w cm	op.	PLN	EUR
V-30053	8	8	6	15,39	-
V-30054	10	10	6	17,10	-



Naczynie bambusowe
Bamboo dish

Nr kat.	l cm	w cm	op.	PLN	EUR
V-30051	15	6,5	6	19,67	-



Naczynie bambusowe
Bamboo dish

Nr kat.	l cm	w cm	op.	PLN	EUR
V-30052	5	5	6	12,83	-



Łyżka Fingerfood
Fingerfood bowl

Nr kat.	Ø cm	op.	PLN	EUR
V-30047	8,5	50	39,19	-





Patyczki bambusowe
Bamboo sticks

Nr kat.	l cm	op.	PLN	EUR
V-30000	7	100	7,30	-
V-30001	10,5	100	9,83	-
V-30002	15	100	6,10	-



Patyczki bambusowe
Bamboo sticks

Nr kat.	l cm	op.	PLN	EUR
V-30003	12	100	8,27	-



Patyczki Bucke
Buckle sticks

Nr kat.	l cm	op.	PLN	EUR
V-30004	15	100	16,25	-



Patyczki bambusowe
Bamboo sticks

Nr kat.	l cm	op.	PLN	EUR
V-30019	12	50	6,70	-



Patyczki bambusowe
Bamboo sticks

Nr kat.	l cm	op.	PLN	EUR
V-30017	12	100	8,84	-



Patyczki bambusowe
Bamboo sticks

Nr kat.	l cm	op.	PLN	EUR
V-30018	12	100	7,64	-



Patyczki Golf
Golf sticks

Nr kat.	l cm	op.	PLN	EUR
V-30005	12	100	4,20	-
V-30006	18	100	4,56	-





Patyczki bambusowe
Bamboo sticks

Nr kat.	l cm	op.	PLN	EUR
V-30025	12	100	15,96	-



Patyczki bambusowe
Bamboo sticks

Nr kat.	l cm	op.	PLN	EUR
V-30026	12	100	14,39	-



Patyczki bambusowe
Bamboo sticks

Nr kat.	l cm	op.	PLN	EUR
V-30016	12	100	8,66	-



Patyczki bambusowe
Bamboo sticks

Nr kat.	l cm	op.	PLN	EUR
V-30015	12	100	8,12	-



Patyczki bambusowe
Bamboo sticks

Nr kat.	l cm	op.	PLN	EUR
V-30014	7,2	100	6,74	-



Patyczki bambusowe
Bamboo sticks

Nr kat.	l cm	op.	PLN	EUR
V-30024	15	100	4,77	-



Patyczki bambusowe
Bamboo sticks

Nr kat.	l cm	op.	PLN	EUR
V-30009	25	100	2,39	-



Patyczki bambusowe
Bamboo sticks

Nr kat.	l cm	op.	PLN	EUR
V-30007	8,5	100	5,99	-





Ekspozytor
Display

Nr kat.	l cm	h cm	w cm	op.	PLN	EUR
V-30056	36,5	14,5	365	1	120,56	-

Liczba otworów: 30 na 1 półkę • 6 półek
30 holes per shelf • 6 shelves



Ekspozytor
Display

Nr kat.	l cm	h cm	w cm	op.	PLN	EUR
V-30057	30	2	99	1	20,52	-

Liczba otworów: 30
30 holes

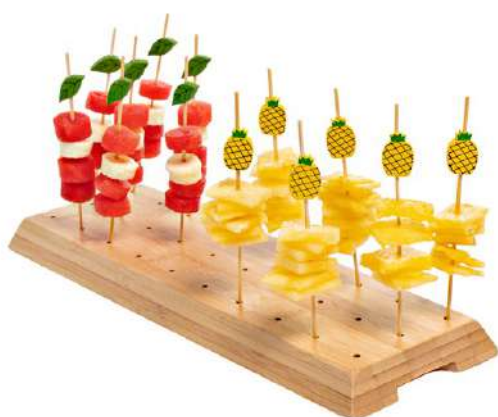

Łyżka drewniana
Wooden spoon

Nr kat.	l cm	op.	PLN	EUR
V-30027	16	100	16,96	-



Widelec drewniany
Wooden fork

Nr kat.	l cm	op.	PLN	EUR
V-30028	16	100	15,39	-



Nóż drewniany
Wooden knife

Nr kat.	l cm	op.	PLN	EUR
V-30029	16,5	100	11,69	-



Wykałaczki
Toothpick

Nr kat.	l cm	op.	PLN	EUR
V-30013	6,5	1000	8,19	-



Widelec bambusowy
Bamboo fork

Nr kat.	l cm	op.	PLN	EUR
V-30012	9	100	2,68	-



Szczypcy bambusowe
Bamboo tong

Nr kat.	l cm	op.	PLN	EUR
V-30055	12	12	5,70	-





Miseczka
Bowl

Nr kat.	Ø cm	h cm	op.	PLN	EUR
RV-648398-6	7	2	6	59,91	-



Miseczka
Bowl

Nr kat.	Ø cm	h cm	op.	PLN	EUR
RV-648400-6	7	2	6	59,91	-



Miseczka
Bowl

Nr kat.	Ø cm	h cm	op.	PLN	EUR
RV-648399-6	7	2	6	59,91	-



Miseczka
Bowl

Nr kat.	Ø cm	h cm	cap ml	op.	PLN	EUR
RV-646421-6	8	6	150	6	61,03	-



Miseczka
Bowl

Nr kat.	Ø cm	h cm	cap ml	op.	PLN	EUR
RV-646422-6	8	6	150	6	61,03	-



Miseczka
Bowl

Nr kat.	Ø cm	h cm	cap ml	op.	PLN	EUR
RV-646423-6	8	6	150	6	61,03	-



RV-645843-6



RV-645844-6



RV-645845-6

Miseczka
Bowl

Nr kat.	Ø cm	cap ml	op.	PLN	EUR
RV-645843-6	7,5	40	6	66,58	-
RV-645844-6	7,5	40	6	66,58	-
RV-645845-6	7,5	40	6	66,58	-



RV-640177-6



RV-644719-6

Miseczka
Bowl

Nr kat.	Ø cm	h cm	cap ml	op.	PLN	EUR
RV-640177-6	6,5	3,5	60	6	29,82	-
RV-644719-6	6,5	3,5	60	6	29,82	-

Ramekin
Ramekin

Nr kat.	Ø cm	cap ml	op.	PLN	EUR
RV-644695-6	9,4	170	6	46,52	-

Naczynie
Dish

Nr kat.	l cm	w cm	cap ml	op.	PLN	EUR
RV-642075-6	7	7	80	6	55,86	-

Rondelek
Saucepan

Nr kat.	Ø cm	cap ml	op.	PLN	EUR
RV-643510-6	10,5	200	6	67,86	-

Miseczka
Bowl

Nr kat.	Ø cm	cap ml	op.	PLN	EUR
RV-644296-6	5	30	6	28,97	-

Miseczka; porcelana
Bowl; porcelain

Nr kat.	l cm	w cm	cap ml	op.	PLN	EUR
RV-648823-12	8	8	80	12	46,04	-

Naczynie
Dish

Nr kat.	l cm	w cm	op.	PLN	EUR
RV-645765-6	8,5	5	6	39,59	-
RV-645768-6	15	5	6	46,90	-
RV-645866-6	27,3	5	6	63,86	-



Miseczka
Bowl

Nr kat.	l cm	w cm	cap ml	op.	PLN	EUR
R-SKSTD11-12	11	11	210	12	20,06	-

Naczynie
Dish

Nr kat.	cap ml	op.	PLN	EUR
R-SPCU07-12	70	12	13,79	-
R-SPCU09-12	90	12	16,30	-

Ramekin
Ramekin

Nr kat.	Ø cm	cap ml	op.	PLN	EUR
R-ACRG09-12	9	190	12	26,09	-

Mlecznik
Milk jug

Nr kat.	h cm	w cm	cap ml	op.	PLN	EUR
R-OPSD03-12	6	5	80	12	20,06	-

Naczynie
Dish

Nr kat.	l cm	w cm	op.	PLN	EUR
R-BACD09-12	9	7	12	13,79	-

Kieliszek na jajko
Egg cup

Nr kat.	h cm	w cm	cap ml	op.	PLN	EUR
R-OPEG01-12	5,2	4,9	12	12	12,54	-

Łyżka azjatycka
Asian spoon

Nr kat.	l cm	op.	PLN	EUR
R-ACSP01-24	12	24	18,64	-





Naczynie
Dish

Nr kat.	l cm	h cm	w cm	op.	PLN	EUR
R-MNTD01-6	7,5	3	6	6	23,83	-



Naczynie
Dish

Nr kat.	l cm	h cm	w cm	cap ml	op.	PLN	EUR
R-OPSD01-12	5	5,5	5	90	12	20,06	-
R-OPSD02-12	5	4,5	5	60	12	17,55	-



Miseczka
Bowl

Nr kat.	Ø cm	cap ml	op.	PLN	EUR
R-SPCU18-12	8	180	12	17,55	-



Naczynie na sos
Dish

Nr kat.	l cm	h cm	w cm	cap ml	op.	PLN	EUR
R-MNSD01-6	6	3	6	60	6	23,83	-



Miseczka
Bowl

Nr kat.	l cm	h cm	w cm	cap ml	op.	PLN	EUR
R-OPSB07-6	7	3,5	7	70	6	12,54	-
R-OPSB09-6	9	5	9	170	6	12,54	-



Naczynie
Dish

Nr kat.	Ø cm	cap ml	op.	PLN	EUR
R-BABR01-12	7	60	12	12,54	-
R-BABR02-12	8	100	12	13,79	-





Naczynie na sos
Dish

Nr kat.	Ø cm	h cm	cap ml	op.	PLN	EUR
R-OPCU12-12	6,5	7	120	12	26,33	-



Miska
Bowl

Nr kat.	Ø cm	cap ml	op.	PLN	EUR
R-FDBI08-12	8	110	12	16,30	-
R-FDBI11-12	11	220	12	23,83	-
R-FDBI12-12	12	280	12	25,07	-
R-FDBI14-12	14	450	12	41,38	-



Naczynie na sos
Dish

Nr kat.	Ø cm	cap ml	op.	PLN	EUR
R-OPCU05-24	5,3	50	24	11,28	-



Rondelek
Saucepan

Nr kat.	Ø cm	l cm	op.	PLN	EUR
R-MNMP01-12	6,2	10	12	19,32	-



Naczynie na wykałaczki
Toothpick holder

Nr kat.	Ø cm	cap ml	op.	PLN	EUR
R-BATH01-12	5,5	70	12	15,05	-



Naczynie
Dish

Nr kat.	Ø cm	op.	PLN	EUR
R-ACYY01-24	10	24	23,61	-



Spodek do espresso / miseczka
Espresso saucer / bowl

Nr kat.	Ø cm	col	op.	PLN	EUR
R-NOSA1-12	10	kość słoniowa	12	10,04	-
R-NOSA3-6	15,5	kość słoniowa	6	12,54	-



Miska
Bowl

Nr kat.	Ø cm	cap ml	col	op.	PLN	EUR
R-SKSRD10-24	10	75	kość słoniowa	24	16,30	-





Chicago

Nr kat.	Ø cm	h cm	cap ml	kosz	op.	PLN	EUR
ON-1650-12 (LB-1650-12)	4	10,5	75	49S434	12	4,36	-



Pucharek Oval; szkło
Goblet Oval; glass

Nr kat.	Ø cm	h cm	cap ml	kosz	op.	PLN	EUR
ON-2580VTC11-6 (LB-922707-6)	11,3	8,1	250	9S318	6	14,43	-



Votive

Nr kat.	Ø cm	h cm	cap ml	kosz	op.	PLN	EUR
ON-1965-36 (LB-1965-36)	6,7	6,3	140	36S318	36	8,95	-



Kieliszek
Glass

Nr kat.	Ø cm	h cm	cap ml	kosz	op.	PLN	EUR
ON-15733-12 (LB-15733-12)	6,9	7,6	110	36S318	12	7,96	-



Cidra

Nr kat.	Ø mm	h mm	cap ml	kosz	op.	PLN	EUR
ON-3282VCP22-6 (LB-920192-12)	83	60	220	25S318	6	8,80	-



Słoik - jogurt; szkło
Jar- yoghurt; glass

Nr kat.	Ø cm	h cm	cap ml	op.	PLN	EUR
C1-100-0051	słoiki	5	7	120	100	4,25 -

Nr kat.	Ø cm	op.	PLN	EUR
C1-100-0007	wieczka	5	750	294,46 -



Słoik Hermetic; szkło
Jar Hermetic; glass

Nr kat.	Ø cm	h cm	cap ml	op.	PLN	EUR
C1-PC-65304-72	4,5	8,5	60	72	7,03	-



Słoik z klamrą, cylinder
Buckle jar, cylinder

Nr kat.	Ø cm	h cm	cap ml	op.	PLN	EUR
T-1125	7,8	9,9	250	4	33,06	-

N



Butelki; szkło
Bottles; glass

Nr kat.	Ø cm	h cm	cap ml	op.	PLN	EUR
C1-1073	butelki 200 ml	5	18	200	24	113,32 -



Kapsle; stal
Cups; steel

Nr kat.	col	op.	PLN	EUR
C1-1075	kapsle złote	złoty	100	36,91 -



Kapslnik; stal, tworzywo
Crimper for cups; steel, plastic

Nr kat.	PLN	EUR
C1-1074	kapslnik	96,60 -



Tubki; Al
Display; 18/10

Nr kat.	cap ml	op.	PLN	EUR
C1-9019	tubki miedziane 30 ml	30	100	370,97 -
C1-9011	zacisk do zamykania	-	-	237,90 -





Stojak na słoiki Weck; 18/10
Stand for Wecks; 18/10

Nr kat.	h cm	PLN	EUR
TF-246	59	462,19	-

Nie zawiera słoiczek
It does not contain jars



Mini słoik
Mini Jar

Nr kat.	Ø mm	cap ml	op.	PLN	EUR
WE-080-60	60	80	12	39,47	-



Mini słoik
Mini Jar

Nr kat.	Ø mm	cap ml	op.	PLN	EUR
WE-761-60	60	140	12	45,34	-
WE-760-60	60	160	12	49,70	-



Więcej słoików marki WECK znajdziesz na str. 288
See more WECK jars on page 288

KUP ON-LINE





Przybory do serwowania Alaska; 18/10
Alaska serving utensils; 18/10

Nr kat.		l mm	thk mm	PLN	EUR
E-2080-10-1	Zestaw do sałaty	238	3,5	90,34	-
E-2080-11-1	Łyżka do sosu	171	3,5	90,34	-
E-2080-12-1	Łyżka do serwowania	251	3,5	63,94	-
E-2080-7-1	Chochelka do wazy	265	3,5	90,34	-
E-2080-8-1	Łopatka do tortu	259	3,5	89,64	-



Przybory do serwowania Atlantis; 18/10
Atlantis serving utensils; 18/10

Nr kat.		l mm	thk mm	PLN	EUR
E-3010-10-1	Zestaw do sałaty	292	3,5	103,96	-
E-3010-12-1	Łyżka do serwowania	225	3,5	51,34	-
E-3010-21-1	Widelec do serwowania	246	3,5	52,26	-
E-3010-7-1	Chochelka do wazy	294	3	86,76	-
E-3010-8-1	Łopatka do tortu	256	4	67,64	-



Przybory do serwowania Ascot; 18/10
Ascot serving utensils; 18/10

Nr kat.		l mm	thk mm	PLN	EUR
E-3050-10-1	Zestaw do sałaty	286	3	94,39	-
E-3050-11-1	Łyżka do sosu	169	2,5	52,90	-
E-3050-12-1	Łyżka do serwowania	247	3	35,24	-
E-3050-7-1	Chochelka do wazy	302	3	82,16	-
E-3050-8-1	Łopatka do tortu	231	2,5	50,06	-





Łyżka do serwowania; 18/10
Serving spoon; 18/10

Nr kat.	l cm	PLN	EUR
T-7800	30	43,94	-



Łyżka do serwowania; 18/10
Serving spoon; 18/10

Nr kat.	l cm	PLN	EUR
T-7720	32,5	51,06	-



Łyżka do serwowania; 18/10
Serving spoon; 18/10

Nr kat.	l cm	w cm	PLN	EUR
T-7820	32	6,5	54,86	-



Łopatka; 18/10
Spatula; 18/10

Nr kat.	l cm	PLN	EUR
T-7760	36	47,98	-

Verlo



Łyżka do serwowania
Serving spoon

Nr kat.	thk mm	PLN	EUR
V-5000-12-12	4,5	26,33	-



Łyżka do serwowania; 18/10
Serving spoon; 18/10

Nr kat.	l cm	PLN	EUR
T-7614	28	40,28	-



Łyżka do serwowania; 18/10
Serving spoon; 18/10

Nr kat.	l cm	PLN	EUR
T-8187	24	36,48	-

Verlo



Widelec do serwowania
Serving fork

Nr kat.	thk mm	PLN	EUR
V-5000-21-12	4,5	22,39	-



Widelec do serwowania; 18/10
Serving fork; 18/10

Nr kat.	l cm	PLN	EUR
T-8188	24	36,48	-



Widelec do sałatek; 18/10
Salad fork; 18/10

Nr kat.	l cm	PLN	EUR
T-7700	30	43,94	-



Chochla; 18/10
Ladle; 18/10

Nr kat.	Ø cm	l cm	cap l	PLN	EUR
T-7770	7	27	0,06	48,93	-
T-7790	9	31	0,1	77,43	-



Łyżka do spaghetti; 18/10
Spaghetti spoon; 18/10

Nr kat.	l cm	PLN	EUR
T-7731	31	54,63	-



Łyżka do sosów; 18/10
Sauce spoon; 18/10

Nr kat.	l cm	PLN	EUR
T-7729	28,5	40,14	-

KUP ON-LINE



CAMBRO

Szczypce; PC
Tongs; PC

Nr kat.	l cm	col	PLN	EUR
CM-TG6110	15	czarny	12,92	-
CM-TG9110	23	czarny	20,52	-

CAMBRO

Szczypce; PC
Tongs; PC

Nr kat.	l cm	col	PLN	EUR
CM-12TGS110	30,5	czarny	30,88	-
CM-12TGS135	30,5	przezroczysty	30,88	-
CM-6TGS110	15	czarny	13,30	-
CM-6TGS135	15	przezroczysty	13,30	-
CM-9TGS110	23	czarny	20,52	-
CM-9TGS135	23	przezroczysty	20,52	-

CAMBRO

Chochla; PC
Ladle; PC

Nr kat.	l cm	cap l	col	PLN	EUR
CM-LD105110	26,8	0,03	czarny	19,48	-
CM-LD85110	21,6	0,025	czarny	19,48	-



CAMBRO

Łyżka do serwowania; PC
Serving spoon; PC

Nr kat.	l cm	w cm	col	PLN	EUR
CM-SPO13CW110	33,3	7,3	czarny	29,07	-
CM-SPO13CW135	33,3	7,3	przezroczysty	29,07	-



Blim®

Zestaw do sałaty; polipropylen
Salad set; polypropylene

Nr kat.	l cm	w cm	col	PLN	EUR
BP-PS3-319	29,3	7	mokka	47,97	-
BP-PS3-000	29,3	7	krystaliczny biały	47,97	-
BP-PS3-010	29,3	7	karbon	47,97	-
BP-PS3-314	29,3	7	leśny średni	47,97	-
BP-PS3-335	29,3	7	morela	47,97	-
BP-PS3-336	29,3	7	ciukier trzciniowy	47,97	-

N

Szczypce; 18/10
Tongs; 18/10

Nr kat.	l cm	PLN	EUR
AB-907	29,5	36,44	-

Szczypce; 18/10
Tongs; 18/10

Nr kat.	l cm	PLN	EUR
AB-905	20	17,19	-

Szczypce; 18/10
Tongs; 18/10

Nr kat.	l cm	PLN	EUR
AB-903	25	28,68	-
AB-904	25	28,68	-
AB-906	25	28,68	-





Szczypce; 18/10
Tongs; 18/10

Nr kat.	l cm	PLN	EUR
AB-908	27	33,51	-



Szczypce; 18/10
Tongs; 18/10

Nr kat.	l cm	PLN	EUR
AB-909	27	33,51	-



Szczypce; 18/10
Tongs; 18/10

Nr kat.	l cm	PLN	EUR
AB-910	27	33,51	-



Szczypce; 18/10
Tongs; 18/10

Nr kat.	l cm	PLN	EUR
T-62307	21	19,38	-



Szczypce; 18/10
Tongs; 18/10

Nr kat.	l cm	w cm	PLN	EUR
T-12671	18,5	3,4	64,00	-



Szczypce do cukru; 18/10
Sugar tongs; 18/10

Nr kat.	l cm	PLN	EUR
T-1999-077	11	7,84	-



Szczypce; 18/10
Tongs; 18/10

Nr kat.	l cm	PLN	EUR
T-9400	20	17,90	-



Szczypce; 18/10
Tongs; 18/10

Nr kat.	l cm	PLN	EUR
T-M606	20	16,30	-



Szczypce; 18/10
Tongs; 18/10

Nr kat.	l cm	PLN	EUR
T-9500	22	17,62	-

KUP ON-LINE





Skrzynka ukośna na sztućce; dąb
Diagonal chest for cutlery; oak

Nr kat.	l cm	h cm	w cm	PLN	EUR
V-11010	53	6,5	32,5	365,20	-



Pojemnik na sztućce; 18/10
Cutlery holder; 18/10

Nr kat.	l cm	h cm	w cm	PLN	EUR
T-HP6323	30	19,5	26,5	225,08	-



Pojemnik na sztućce; PE
Cutlery holder; PE

Nr kat.	l cm	h cm	w cm	PLN	EUR
T-8114	53	9,5	32,5	25,69	-



Kosz na sztućce; polirattan, 18/10
Cutlery holder; polirattan, 18/10

Nr kat.	l cm	w cm	PLN	EUR
TF-65	53	32,5	130,15	-



BH-2005-061



BH-2005-301

Koszyk na sztućce; polirattan
Cutlery basket; polirattan

Nr kat.	Ø cm	h cm	PLN	EUR
BH-2005-061	12	15	23,04	-
BH-2005-301	12	15	23,04	-



BH-2069-061



BH-2069-301

Koszyk na sztućce; polirattan
Cutlery basket; polirattan

Nr kat.	l cm	h cm	w cm	PLN	EUR
BH-2069-061	27	4,5	10	23,04	-
BH-2069-301	27	4,5	10	23,04	-



Podstawa pod łyżkę; porcelana
Spoon holder; porcelain

Nr kat.	l cm	w cm	col	op.	PLN	EUR
RV-644293-3	19,7	10,4	czarny	3	96,67	-

Brak łyżki w zestawie
Spoon is not included



Talerz płaski
Flat plate

Nr kat.	l cm	w cm	col	op.	PLN	EUR
R-CLRP29-12	29	12	kość słoniowa	12	66,45	-



Przyprawnik - sól, pieprz; 18/10, szkło
Condiment set; 18/10, glass

Nr kat.	l cm	h cm	w cm	PLN	EUR
T-1102	8	12	3,5	17,93	-



Zestaw do przypraw 4 częściowy; 18/10, szkło
Condiment set; 18/10, glass

Nr kat.	l cm	h cm	w cm	PLN	EUR
T-1404	9,5	22	9,5	40,88	-



Zestaw do oliwy 2 częściowy; 18/10, szkło
Olive oil, acid set; 18/10, glass

Nr kat.	l cm	h cm	w cm	PLN	EUR
T-1202	11	22	5	37,76	-



Butelka na ocet, oliwę; szkło
Olive oil, acid bottle; glass

Nr kat.	h cm	cap ml	PLN	EUR
4021	20	120	234,41	-

Produkt ręcznie wykonany • Dwa korki
Hand made product • Two plugs



Butelka na oliwę i ocet; szkło
Bottle for olive oil and acid; glass

Nr kat.	h cm	cap ml	PLN	EUR
4983	24	450	234,41	-

Produkt ręcznie wykonany • Dwa korki
Hand made product • Two plugs



Butelka na ocet, oliwę; szkło
Olive oil, acid bottle; glass

Nr kat.	h cm	cap ml	PLN	EUR
4985	20	200	234,41	-

Produkt ręcznie wykonany • Dwa korki
Hand made product • Two plugs



Butelka na oliwę i ocet; szkło
Olive oil, acid bottle; glass

Nr kat.	h cm	cap ml	PLN	EUR
4022	18	250	244,39	-

Produkt ręcznie wykonany • Wewnętrzny pojemnik na przyprawę z otworami
Hand-made product • Inner spice container with holes

Hand-made product • Inner spice container with holes



Zobacz młynki i akcesoria firmy PEUGEOT na str. 528
See PEUGEOT mills and accessories on page 528





Dozownik do miodu; szkło, 18/10
Honey dispenser; 18/10, glass

Nr kat.	Ø cm	h cm	cap ml	PLN	EUR
T-337-200	8,5	15	200	80,99	-



Butelka na ocet, oliwę; szkło
Olive oil, acid bottle; glass

Nr kat.	h cm	cap ml	PLN	EUR
4011	18	200	234,41	-

Produkt ręcznie wykonany • Szklana zatyczka
Hand made product • Glass stopper



Butelka z nalewakiem; 18/10, porcelana
Bottle with pourer; porcelain

Nr kat.	l cm	h cm	w cm	cap l	op.	PLN	EUR
RV-645302-6	8,3	16,5	7,9	0,25	2	133,49	-



Dzbanek do oliwy, octu; szkło
Jug for olive oil, acid; glass

Nr kat.	Ø cm	h cm	cap ml	op.	PLN	EUR
LB-75305-12	7,3	11	170	12	19,96	-



BarEq

Nalewak precyzyjny; stal
Precision pourer; steel

Nr kat.	PLN	EUR
T-31100	16,72	-



Kieliszek na jajko
Egg cup

Nr kat.	cap ml	op.	PLN	EUR
R-BAEG01-6	45	6	16,30	-



Mlecznik
Milk jug

Nr kat.	cap ml	op.	PLN	EUR
R-GJGU09-12	90	12	21,32	-
R-GJGU15-12	150	12	23,83	-



Mlecznik
Milk jug

Nr kat.	cap ml	op.	PLN	EUR
R-FDCR05-24	50	24	26,33	-
R-FDCR15-6	150	6	37,61	-
R-FDCR25-6	250	6	45,14	-
R-FDCR40-6	400	6	56,43	-



Sosjerka
Sauce boat

Nr kat.	cap ml	op.	PLN	EUR
R-BAGB15-6	150	6	42,63	-
R-BAGB35-4	350	4	43,89	-





Cukiernica
Sugar bowl

Nr kat.	Ø cm	cap ml	op.	PLN	EUR
R-BASH02-12	8,5	230	12	21,32	-



Cukiernica
Sugar bowl

Nr kat.	l cm	h cm	w cm	cap ml	op.	PLN	EUR
R-BASH01-6	11	4	7	200	6	28,84	-



Cukiernica
Sugar bowl

Nr kat.	Ø cm	cap ml	op.	PLN	EUR
R-BASU27-6	9,5	270	6	46,39	-



Cukiernica
Sugar bowl

Nr kat.	Ø cm	cap ml	op.	PLN	EUR
R-CLSU27-6	8,5	270	6	56,43	-



Pojemnik na odpadki; 18/10
Bin; 18/10

Nr kat.	Ø cm	h cm	PLN	EUR
T-1020	12	18	72,44	-

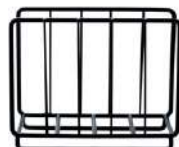

Serwetnik; stal
Napkin holder; steel

Nr kat.	l cm	h cm	w cm	PLN	EUR
V-1541	14	11,5	6	14,52	-

Verlo



Serwetnik; 18/10
Napkin holder; 18/10

Nr kat.	l cm	h cm	w cm	PLN	EUR
T-2265	16,5	8	3	29,67	-

BarEq



T-132-11



T-TB01W

Pomocnik barmański; tworzywo
Bar caddy; plastic

Nr kat.	l cm	h cm	w cm	PLN	EUR
T-132-11	15	10,5	24	42,18	-
T-TB01W	25	10,5	25	41,81	-

oris



Popielniczka; szkło
Ashtray; glass

Nr kat.	Ø cm	h cm	op.	PLN	EUR
ON-2099VCZ10-12 (LB-920895-12)	11	3,78	12	7,60	-

KUP ON-LINE



Więcej akcesoriów do serwowania na str. 439–440

See more serving accessories on pages 439–440



Karta menu; porcelana
Menu stand; porcelain

Nr kat.	l cm	h cm	op.	PLN	EUR
RV-641279-6	5,6	5,7	6	45,51	-

Do stosowania z markerem wodnym
For use with a water marker



Zestaw stojaków na menu; stal
Menu stands; steel

Nr kat.	l cm	w cm	PLN	EUR
TF-022	10	5,7	65,85	-

Zestaw: 6 chromowanych stojaków i 12 plastikowych kart menu •
Do stosowania z markerem wodnym

Set: 6 chrome stands and 12 plastic menu cards • For use with a water marker



Verlo

Tabliczka menu; PP
Menu board; PP

Nr kat.	l cm	w cm	col	op.	PLN	EUR
V-7518	9	10,8	czarny	6	50,84	-



Verlo

Tabliczka menu; PP
Menu board; PP

Nr kat.	l cm	w cm	col	op.	PLN	EUR
V-7519	16	7,8	czarny	6	50,84	-



Marker wodny
Water marker

Nr kat.	PLN	EUR
T-7660	13,78	-

Zmywalny
Washable



Stojak bankietowy; 18/10
Banquet holder; 18/10

Nr kat.	h cm	PLN	EUR
T-1001-10	16	20,52	-
T-1001-11	19	22,23	-



Zestaw stojaków na menu; drewno
Menu stands; wood

Nr kat.	l cm	h cm	w cm	PLN	EUR
TF-023	8,5	5	6,5	41,00	-

Zestaw: 2 stojaki • Możliwość postawienia w pionie
Set: 2 racks • Possibility to stand vertically



Tabliczka - rezerwacja; 18/0
Reservation sign; 18/0

Nr kat.	l cm	h cm	w cm	thk mm	PLN	EUR
T-3801-012	12	4,3	3,5	1,5	16,43	-



Tabliczka - zakaz palenia; 18/0
No smoking sign; 18/0

Nr kat.	l cm	h cm	thk mm	PLN	EUR
T-3701-053	5,3	3,5	1,5	8,52	-



Pokrywa; 18/10
Cover; 18/10

Nr kat.	Ø cm	h cm	PLN	EUR
P-9322	28	15	229,14	-

Do talerzy o śr. max. 27 cm
Max. dia. of plate 27 cm



CAMBRO

Pokrywa do talerza; PC
Plate cover; PC

Nr kat.	Ø cm	PLN	EUR
CM-1202CW152	30,8	58,24	-

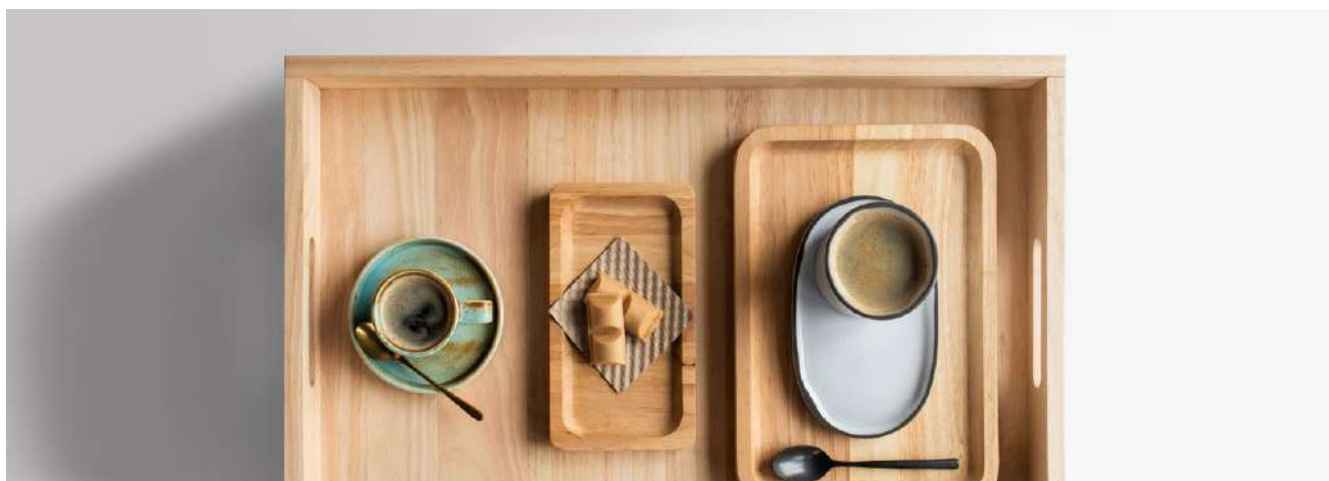

N

Taca; mango
Tray; mango

Nr kat.	l cm	h cm	w cm	op.	PLN	EUR
V-D1008	58	6	37	1	118,50	-

Lakierowana • dwa uchwyty
Lacquered • two handles



N

Taca; mango
Tray; mango

Nr kat.	l cm	h cm	w cm	op.	PLN	EUR
V-D1009	46	6	30	1	89,85	-

Lakierowana • dwa uchwyty
Lacquered • two handles



N

Taca; mango
Tray; mango

Nr kat.	l cm	h cm	w cm	op.	PLN	EUR
V-D1010	58	6	19	1	81,75	-

Lakierowana • dwa uchwyty
Lacquered • two handles



Taca kelnerska; Drewno dębowe
Service tray; oak

Nr kat.	l cm	h cm	w cm	PLN	EUR
V-60402	60	12	40	290,84	-

Taca dębowa serwisowa • lakierowana • bejcowana • kolor czarny
Oak service tray • varnished • stained • black colour



Taca kelnerska; Drewno dębowe
Service tray; oak

Nr kat.	l cm	h cm	w cm	PLN	EUR
V-60401	60	12	40	290,84	-

Taca dębowa serwisowa • lakierowana
Oak service tray • varnished



N

Stojak do tac; drewno
Tray jack; wood

Nr kat.	l cm	h cm	PLN	EUR
V-ST8746	43	87	376,88	-

Łatwe rozkładanie • drewno dębowe lakierowane w kolorze czarnym.
Easy to unfold • black lacquered oak wood.





BarEq

Taca okrągła; włókno szklane, guma
Tray round; polyglass, rubber

Nr kat.	Ø cm	h cm	PLN	EUR
BQ-35522	35,5	2,2	32,30	-
BQ-40522	40,5	2,2	43,70	-



CAMBRO

Taca kelnerska; poliglass, guma
Waiters tray; polyglass, rubber

Nr kat.	Ø cm	col	PLN	EUR
CM-1400TL110	35,5	czarny	56,86	-
CM-1400TL138	35,5	brązowy	56,86	-
CM-1600TL110	40,5	czarny	76,81	-
CM-1600TL138	40,5	brązowy	76,81	-

Odporna na temp. - 10°C do 80°C. Odporna na umiarkowane użytkowanie.
Temp resistant -10 to 80 C. Medium intensity of use.



CAMBRO

Taca kelnerska; poliglass, guma, Al
Waiters tray; polyglass, rubber, Al.

Nr kat.	Ø cm	col	PLN	EUR
CM-1400CT110	35,5	czarny	48,84	-
CM-1400CT138	35,5	brązowy	48,84	-
CM-1600CT110	40,5	czarny	65,56	-
CM-1600CT138	40,5	brązowy	65,56	-
CM-1800CT110	45	czarny	81,67	-

Odporna na temp. - 10°C do 100°C. Gumowana łącznie z brzegami. Odporna na intensywne użytkowanie.

Temp resistant -10 to 100 C. Rubberized with rims. Heavy duty.



CAMBRO

Taca kelnerska; poliglass, guma, Al
Waiters tray; polyglass, rubber, Al.

Nr kat.	l cm	w cm	col	PLN	EUR
CM-2700CT110	68,5	56	czarny	150,48	-
CM-2700CT138	68,5	56	brązowy	150,48	-

Odporna na temp. - 10°C do 100°C. Gumowana łącznie z brzegami. Odporna na intensywne użytkowanie.

Temp resistant -10 to 100 C. Rubberized with rims. Heavy duty.



CAMBRO

Taca kelnerska; poliglass, guma, Al
Waiters tray; polyglass, rubber, Al.

Nr kat.	l cm	w cm	col	PLN	EUR
CM-1418CT138	46	36	brązowy	75,43	-

Odporna na temp. - 10°C do 100°C. Gumowana łącznie z brzegami. Odporna na intensywne użytkowanie.

Temp resistant -10 to 100 C. Rubberized with rims. Heavy duty.



CAMBRO

Taca kelnerska; poliglass, guma
Waiters tray; polyglass, rubber

Nr kat.	l cm	w cm	col	PLN	EUR
CM-1418TL110	46	36	czarny	86,07	-
CM-1418TL138	46	36	brązowy	86,07	-

Odporna na temp. - 10°C do 80°C. Odporna na umiarkowane użytkowanie.

Temp resistant -10 to 80 C. Medium intensity of use.



KUP ON-LINE



Marke WECK Gläser

Weck jest synonimem gwarancji jakości dla wielu uznanych restauracji, kawiarni, czy firm cateringowych na całym świecie. Funkcja wekowania jest nie mniej istotna, jak sam trend serwowania dań w naczyniach „klasykach” z logo truskawki.

Weck is synonymous with a quality guarantee for many recognised restaurants, cafes, and caterers around the world. The function of canning is no less important than the trend of serving dishes in „classic” containers with the strawberry logo.

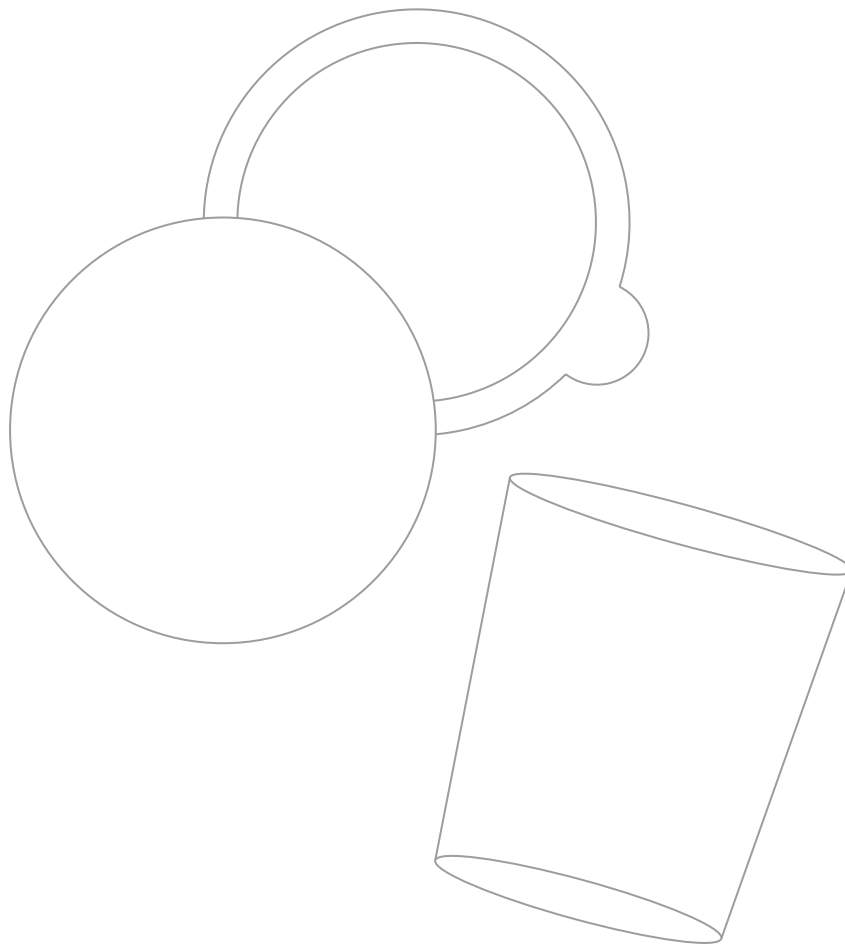

historia

Szklane słoiki i butelki WECK od ponad 100 lat są synonimem tradycji i najwyższej jakości. Proces wekowania swoją nazwę zawdzięcza właśnie unikalnemu projektowi słoików stworzonemu w 1900 roku przez Johanna Wecka.

history: WECK glass jars and bottles have been synonymous with tradition and top quality for more than 100 years. The process of canning gets its name from the unique jar design created in 1900 by Johann Weck.

eko

Szkoło Weck jest grube i trwałe, posiada doskonałe cechy fizyczne. Produkty są wielorazowego użytku dzięki czemu wspierają oszczędne gospodarowanie zasobami naturalnymi naszej planety.

eco: Weck glass is thick and durable and it has excellent physical features. The products are reusable, thanks to which they support the economical management of natural resources of our planet.

Wysoką jakość produktów szklanych oraz wszystkich elementów mających bezpośrednią styczność z żywnością, potwierdzają stosowne certyfikaty wydane przez niezależne instytucje badawcze w Niemczech i Unii Europejskiej.

The high quality of glass products and all the elements that have direct contact with food is confirmed by appropriate certificates issued by independent research institutions in Germany and the European Union.



Słoik Bakery
Bakery jar

Nr kat.	Ø mm	h mm	cap ml	op.	PLN	EUR
WE-566-60	60	55	80	12	74,63	-
WE-561-80	55	55	165	12	86,78	-
WE-568-100	100	58	280	6	52,51	-
WE-564-120	120	63	450	6	85,52	-

Słoik Bakery z pokrywą
Bakery jar with lid

Nr kat.	Ø mm	h mm	cap ml	op.	PLN	EUR
WE-566-60P	60	60	80	12	105,12	-
WE-561-80P	55	60	165	12	120,83	-
WE-568-100P	100	63	280	6	70,39	-
WE-564-120P	120	68	450	6	119,69	-

Słoik Bakery komplet*
*Bakery jar set**

Nr kat.	Ø mm	h mm	cap ml	op.	PLN	EUR
WE-566-60PUZ	60	64	80	12	141,35	-
WE-561-80PUZ	55	64	165	12	157,28	-
WE-568-100PUZ	100	67	280	6	89,54	-
WE-564-120PUZ	120	72	450	6	141,12	-



Słoik Barrel
Barrel Jar

Nr kat.	Ø mm	h mm	cap ml	op.	PLN	EUR
WE-776-100	100	250	3000	4	89,61	-

Słoik Barrel z pokrywą
Barrel Jar with lid

Nr kat.	Ø mm	h mm	cap ml	op.	PLN	EUR
WE-776-100P	100	250	3000	4	101,54	-

Słoik Barrel, komplet*
*Barrel Jar set**

Nr kat.	Ø mm	h mm	cap ml	op.	PLN	EUR
WE-776-100PUZ	100	250	3000	4	114,27	-

* – Komplet zawiera: pokrywkę, uszczelkę, 2 zapinki | *Set includes: lid, seal, 2 clasps*





Słoik Quadro
Quadro jar

Nr kat.	Ø mm	h mm	cap ml	op.	PLN	EUR
WE-768-100	100	60	290	6	31,75	-
WE-747-100	100	110	545	6	38,98	-
WE-769-100	100	160	795	6	50,33	-



Słoik Quadro z pokrywką
Quadro jar with lid

Nr kat.	Ø mm	h mm	cap ml	op.	PLN	EUR
WE-768-100P	100	65	290	6	49,64	-
WE-747-100P	100	115	545	6	56,98	-
WE-769-100P	100	165	795	6	68,21	-



Słoik Quadro komplet*
Quadro jar set*

Nr kat.	Ø mm	h mm	cap ml	op.	PLN	EUR
WE-768-100PUZ	100	69	290	6	68,90	-
WE-747-100PUZ	100	119	545	6	76,12	-
WE-769-100PUZ	100	169	795	6	87,35	-





Mini słoik
Mini Jar

Nr kat.	Ø mm	h mm	cap ml	op.	PLN	EUR
WE-756-40	40	37	35	12	33,06	-
WE-080-60	60	47	80	12	39,47	-
WE-751-80	80	56	200	12	51,71	-



Mini słoik z pokrywką
Mini Jar with lid

Nr kat.	Ø mm	h mm	cap ml	op.	PLN	EUR
WE-756-40P	40	42	35	12	58,79	-
WE-080-60P	60	52	80	12	67,62	-
WE-751-80P	80	61	200	12	78,01	-



Mini słoik, komplet*
Mini Jar set*

Nr kat.	Ø mm	h mm	cap ml	op.	PLN	EUR
WE-756-40PUZ	40	46	35	12	89,83	-
WE-080-60PUZ	60	56	80	12	99,32	-
WE-751-80PUZ	80	65	200	12	105,35	-



Mini słoik
Mini Jar

Nr kat.	Ø mm	h mm	cap ml	op.	PLN	EUR
WE-755-60	60	37	50	12	51,90	-
WE-976-80	80	47	165	12	46,96	-



Mini słoik z pokrywką
Mini Jar with lid

Nr kat.	Ø mm	h mm	cap ml	op.	PLN	EUR
WE-755-60P	60	42	50	12	81,91	-
WE-976-80P	80	52	165	12	76,95	-



Mini słoik, komplet*
Mini Jar set*

Nr kat.	Ø mm	h mm	cap ml	op.	PLN	EUR
WE-755-60PUZ	60	46	50	12	113,79	-
WE-976-80PUZ	80	56	165	12	108,84	-



Mini słoik
Mini Jar

Nr kat.	Ø mm	h mm	cap ml	op.	PLN	EUR
WE-761-60	60	69	140	12	45,34	-
WE-760-60	60	80	160	12	49,70	-



Mini słoik z pokrywką
Mini Jar with lid

Nr kat.	Ø mm	h mm	cap ml	op.	PLN	EUR
WE-761-60P	60	74	140	12	73,66	-
WE-760-60P	60	85	160	12	78,16	-



Mini słoik, komplet*
Mini Jar set*

Nr kat.	Ø mm	h mm	cap ml	op.	PLN	EUR
WE-760-60PUZ	60	89	160	12	109,86	-
WE-761-60PUZ	60	78	140	12	105,36	-



KUP ON-LINE



* – Komplet zawiera: pokrywkę, uszczelkę, 2 zapinki | Set includes: lid, seal, 2 clasps



Słoik Mold
Mold Jar

Nr kat.	Ø mm	h mm	cap ml	op.	PLN	EUR
WE-740-100	100	55	290	6	30,84	-
WE-750-120	120	48	300	6	48,27	-
WE-741-100	100	69	370	6	33,19	-
WE-565-120	125	63	450	6	71,08	-



Słoik Mold z pokrywką
Mold Jar with lid

Nr kat.	Ø mm	h mm	cap ml	op.	PLN	EUR
WE-740-100P	100	60	290	6	42,19	-
WE-750-120P	120	53	300	6	72,11	-
WE-741-100P	100	74	370	6	43,75	-
WE-565-120P	125	68	450	6	105,12	-



Słoik Mold, komplet*
*Mold Jar set**

Nr kat.	Ø mm	h mm	cap ml	op.	PLN	EUR
WE-740-100PUZ	100	64	290	6	58,46	-
WE-750-120PUZ	120	57	300	6	89,19	-
WE-741-100PUZ	100	78	370	6	60,46	-
WE-565-120PUZ	125	72	450	6	126,57	-



Słoik Mold
Mold Jar

Nr kat.	Ø mm	h mm	cap ml	op.	PLN	EUR
WE-900-80	80	87	290	6	31,41	-
WE-742-100	100	107	580	6	38,41	-
WE-743-100	100	147	850	6	52,39	-



Słoik Mold z pokrywką
Mold Jar with lid

Nr kat.	Ø mm	h mm	cap ml	op.	PLN	EUR
WE-900-80P	80	92	290	6	41,44	-
WE-742-100P	100	112	580	6	50,41	-
WE-743-100P	100	152	850	6	62,71	-



Słoik Mold, komplet*
*Mold Jar set**

Nr kat.	Ø mm	h mm	cap ml	op.	PLN	EUR
WE-900-80PUZ	80	96	290	6	57,38	-
WE-742-100PUZ	100	116	580	6	67,10	-
WE-743-100PUZ	100	156	850	6	76,45	-





Słoik cylindryczny
Cylindric Jar

Nr kat.	Ø mm	h mm	cap ml	op.	PLN	EUR
WE-789-40	40	85	145	12	43,68	-



Słoik cylindryczny z pokrywką
Cylindric Jar with lid

Nr kat.	Ø mm	h mm	cap ml	op.	PLN	EUR
WE-789-40P	40	90	145	12	73,25	-



Słoik cylindryczny komplet*
*Cylindric Jar set**

Nr kat.	Ø mm	h mm	cap ml	op.	PLN	EUR
WE-789-40PUZ	40	94	145	12	109,14	-



Słoik cylindryczny
Cylindric Jar

Nr kat.	Ø mm	h mm	cap ml	op.	PLN	EUR
WE-908-80	80	210	1040	6	57,08	-
WE-974-100	100	210	1590	6	85,52	-



Słoik cylindryczny z pokrywką
Cylindric Jar with lid

Nr kat.	Ø mm	h mm	cap ml	op.	PLN	EUR
WE-908-80P	80	215	1040	6	72,08	-
WE-974-100P	100	215	1590	6	101,19	-



Słoik cylindryczny, komplet*
*Cylindric Jar set**

Nr kat.	Ø mm	h mm	cap ml	op.	PLN	EUR
WE-908-80PUZ	80	219	1040	6	88,02	-
WE-974-100PUZ	100	219	1590	6	117,89	-



Słoik cylindryczny
Cylindric Jar

Nr kat.	Ø mm	h mm	cap ml	op.	PLN	EUR
WE-975-60	60	130	340	6	34,04	-
WE-905-60	60	210	600	6	49,28	-



Słoik cylindryczny z pokrywką
Cylindric Jar with lid

Nr kat.	Ø mm	h mm	cap ml	op.	PLN	EUR
WE-975-60P	60	135	340	6	47,52	-
WE-905-60P	60	215	600	6	62,76	-



Słoik cylindryczny, komplet*
*Cylindric Jar set**

Nr kat.	Ø mm	h mm	cap ml	op.	PLN	EUR
WE-975-60PUZ	60	139	340	6	63,38	-
WE-905-60PUZ	60	219	600	6	78,61	-



Słoik cylindryczny
Cylindric Jar

Nr kat.	Ø mm	h mm	cap ml	op.	PLN	EUR
WE-782-100	100	160	1050	6	69,63	-
WE-784-100	100	232	1500	6	95,02	-



Słoik cylindryczny z pokrywką
Cylindric Jar with lid

Nr kat.	Ø mm	h mm	cap ml	op.	PLN	EUR
WE-782-100P	100	165	1050	6	84,21	-
WE-784-100P	100	237	1500	6	112,51	-



Słoik cylindryczny, komplet*
*Cylindric Jar set**

Nr kat.	Ø mm	h mm	cap ml	op.	PLN	EUR
WE-782-100PUZ	100	169	1050	6	102,86	-
WE-784-100PUZ	100	241	1500	6	131,16	-

* – Komplet zawiera: pokrywkę, uszczelkę, 2 zapinki | *Set includes: lid, seal, 2 clasps*



Słoik Tulip
Tulip jar

Nr kat.	Ø mm	h mm	cap ml	op.	PLN	EUR
WE-788-40	40	55	75	12	38,75	-
WE-762-60	60	80	220	12	55,91	-
WE-746-80	80	86	370	6	38,86	-



Słoik Tulip z pokrywką
Tulip jar with lid

Nr kat.	Ø mm	h mm	cap ml	op.	PLN	EUR
WE-788-40P	40	60	75	12	68,44	-
WE-762-60P	60	85	220	12	82,86	-
WE-746-80P	80	91	370	6	50,15	-



Słoik Tulip komplet*
*Tulip jar set**

Nr kat.	Ø mm	h mm	cap ml	op.	PLN	EUR
WE-788-40PUZ	40	64	75	12	104,21	-
WE-762-60PUZ	60	89	220	12	114,57	-
WE-746-80PUZ	80	95	370	6	66,10	-



Słoik Tulip
Tulip Jar

Nr kat.	Ø mm	h mm	cap ml	op.	PLN	EUR
WE-744-100	100	85	580	6	39,89	-
WE-745-100	100	147	1062	6	48,02	-



Słoik Tulip z pokrywką
Tulip Jar with lid

Nr kat.	Ø mm	h mm	cap ml	op.	PLN	EUR
WE-744-100P	100	90	580	6	52,60	-
WE-745-100P	100	152	1062	6	58,01	-



Słoik Tulip, komplet*
*Tulip Jar set**

Nr kat.	Ø mm	h mm	cap ml	op.	PLN	EUR
WE-744-100PUZ	100	94	580	6	69,31	-
WE-745-100PUZ	100	156	1062	6	74,72	-



Słoik Tulip
Tulip Jar

Nr kat.	Ø mm	h mm	cap ml	op.	PLN	EUR
WE-738-100	100	190	1750	4	79,18	-
WE-739-100	100	242	2700	4	89,41	-



Słoik Tulip z pokrywką
Tulip Jar with lid

Nr kat.	Ø mm	h mm	cap ml	op.	PLN	EUR
WE-738-100P	100	195	1750	4	89,62	-
WE-739-100P	100	247	2700	4	99,86	-



Słoik Tulip, komplet*
*Tulip Jar set**

Nr kat.	Ø mm	h mm	cap ml	op.	PLN	EUR
WE-738-100PUZ	100	199	1750	4	100,75	-
WE-739-100PUZ	100	251	2700	4	110,99	-



Słoik Deco
Deco Jar

Nr kat.	Ø mm	h mm	cap ml	op.	PLN	EUR
WE-902-60	60	66	220	12	60,63	-
WE-901-80	80	88	560	6	47,00	-
WE-748-100	100	105	1062	4	48,49	-



Słoik Deco z pokrywką
Deco Jar with lid

Nr kat.	Ø mm	h mm	cap ml	op.	PLN	EUR
WE-902-60P	60	71	220	12	87,58	-
WE-901-80P	80	93	560	6	59,71	-
WE-748-100P	100	110	1062	4	54,68	-



Słoik Deco, komplet*
*Deco Jar set**

Nr kat.	Ø mm	h mm	cap ml	op.	PLN	EUR
WE-902-60PUZ	60	75	220	12	119,28	-
WE-901-80PUZ	80	97	560	6	75,65	-
WE-748-100PUZ	100	114	1062	4	66,81	-





Słoik Deli
Deli Jar

Nr kat.	Ø mm	h mm	cap ml	op.	PLN	EUR
WE-757-40	40	102	100	6	30,37	-
WE-995-60	60	122	200	6	29,33	-



Słoik Deli z pokrywką
Deli Jar with lid

Nr kat.	Ø mm	h mm	cap ml	op.	PLN	EUR
WE-757-40P	40	107	100	6	41,18	-
WE-995-60P	60	127	200	6	42,81	-



Słoik Deli, komplet*
Deli Jar set*

Nr kat.	Ø mm	h mm	cap ml	op.	PLN	EUR
WE-757-40PUZ	40	111	100	6	56,70	-
WE-995-60PUZ	60	131	200	6	58,66	-



Słoik Deli
Deli Jar

Nr kat.	Ø mm	h mm	cap ml	op.	PLN	EUR
WE-996-80	80	122	370	6	39,48	-
WE-758-80	80	205	700	6	54,57	-



Słoik Deli z pokrywką
Deli Jar with lid

Nr kat.	Ø mm	h mm	cap ml	op.	PLN	EUR
WE-996-80P	80	127	370	6	50,39	-
WE-758-80P	80	210	700	6	65,94	-



Słoik Deli, komplet*
Deli Jar set*

Nr kat.	Ø mm	h mm	cap ml	op.	PLN	EUR
WE-996-80PUZ	80	131	370	6	66,33	-
WE-758-80PUZ	80	214	700	6	81,89	-



KUP ON-LINE

* – Komplet zawiera: pokrywkę, uszczelkę, 2 zapinki | Set includes: lid, seal, 2 clasps



Butelka
Bottle

Nr kat.	Ø mm	h mm	cap ml	op.	PLN	EUR
WE-763-60	60	140	290	6	37,11	-
WE-764-60	60	184	530	6	40,28	-



Butelka z pokrywką
Bottle with lid

Nr kat.	Ø mm	h mm	cap ml	op.	PLN	EUR
WE-763-60P	60	145	290	6	50,59	-
WE-764-60P	60	189	530	6	53,76	-



Butelka, komplet*
*Bottle set**

Nr kat.	Ø mm	h mm	cap ml	op.	PLN	EUR
WE-763-60PUZ	60	149	290	6	66,45	-
WE-764-60PUZ	60	193	530	6	69,61	-



Butelka
Bottle

Nr kat.	Ø mm	h mm	cap ml	op.	PLN	EUR
WE-766-60	60	250	1062	6	59,49	-



Butelka z pokrywką
Bottle with lid

Nr kat.	Ø mm	h mm	cap ml	op.	PLN	EUR
WE-766-60P	60	255	1062	6	69,99	-



Butelka, komplet*
*Bottle set**

Nr kat.	Ø mm	h mm	cap ml	op.	PLN	EUR
WE-766-60PUZ	60	259	1062	6	85,84	-





Pasują wszystkie słoiczki o śr. 80 mm
All 80 mm Ø jars fit this item:

Stojak na słoiki Weck; 18/10 Stand for Wecks; 18/10

Nr kat.	h cm	PLN	EUR
TF-246	59	462,19	-

Nie zawiera słoiczek
It does not contain jars

Pasują wszystkie słoiczki o śr. 80 mm
All 80 mm Ø jars fit this item:

Verlo



Deska z otworami; dąb Board with holes; oak

Nr kat.	Ø o cm	l cm	h cm	w cm	PLN	EUR
V-11519	7,3	50	2	10	105,00	-
V-11520	6,3	50	2	10	105,00	-



N

Pokrywka drewniana z uszczelką Wooden lid with gasket

Nr kat.	Ø cm	op.	PLN	EUR
V-D60	6	3	31,71	-
V-D80	8	3	36,59	-
V-D100	10	3	44,72	-



Pokrywka Lid

Nr kat.	Ø mm	op.	PLN	EUR
WE-40	40	6	14,68	-
WE-60	60	6	15,59	-
WE-80	80	6	15,93	-
WE-100	100	6	17,65	-
WE-120	120	6	34,37	-



Pokrywka Keep Fresh, PE Keep Fresh Lid

Nr kat.	Ø mm	op.	PLN	EUR
WE-K40	40	5	9,39	-
WE-K60	60	5	10,89	-
WE-K80	80	5	13,28	-
WE-K100	100	5	19,10	-
WE-K120	120	5	24,47	-



Uszczelka; kauczuk Gasket; caoutchouc

Nr kat.	Ø mm	op.	PLN	EUR
WE-USZ40	40	6	3,76	-
WE-USZ60	60	6	4,70	-
WE-USZ80	80	6	4,87	-
WE-USZ100	100	6	5,64	-
WE-USZ120	120	6	7,52	-



Zapinki; stal Clasp; steel

Nr kat.	op.	PLN	EUR
WE-ZAP	12	15,04	-



Chwytek do słoików; stal Grasper; steel

Nr kat.	op.	PLN	EUR
WE-UCH	1	107,57	-



Lejek; PE Funnel; PE

Nr kat.	op.	PLN	EUR
WE-LE	1	62,49	-

KUP ON-LINE



Verlo

Jej ręczne wykonanie, najwyższej jakości szlachetna porcelana i charakterystyczny design, tworzą wrażenie przenikania się klasyki z nowoczesnością. Wszystkie linie porcelany Verlo zostały stworzone z myślą o gastronomii, są wytrzymałe i odporne na wyszczerbienia, a różnorodność form, struktur i kolorów będzie wspaniałym tłem dla efektów kreatywności każdego szefa kuchni.

Its hand-made workmanship, the highest-quality fine porcelain and the distinctive design create an impression of merging the classic with modernity. All lines of Verlo porcelain have been created with gastronomy in mind, are durable and resistant to chipping, and the variety of forms, structures and colors will be a great background for the creativity of every chef.

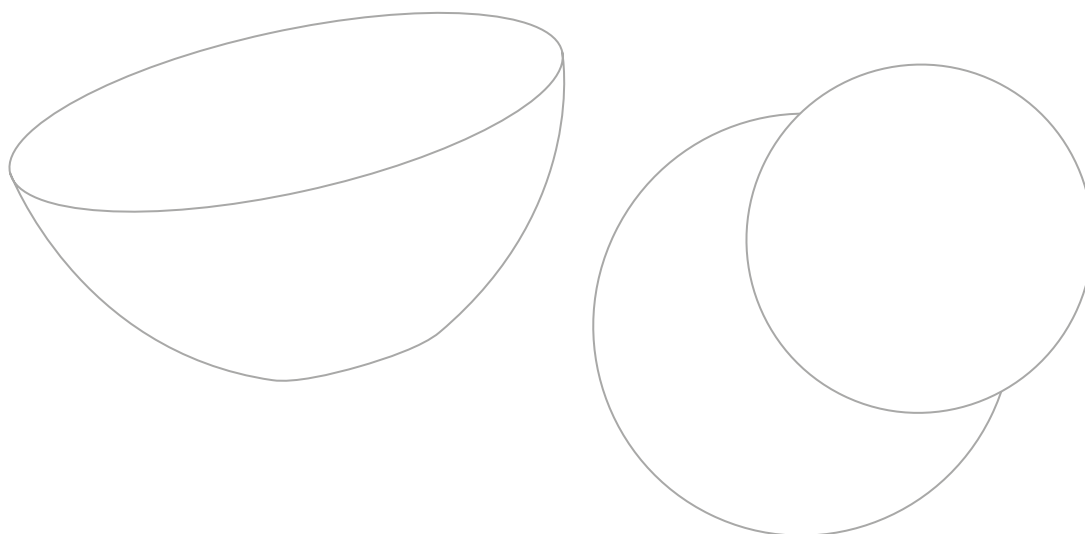

surowiec

Najwyższa jakość 100% porcelany oraz wypalanie w temp. 1380 °C gwarantują odporność na zmywanie w zmywarce oraz wyszczerbienia.

raw material: *The highest quality 100% porcelain and firing in the temperature of 1380 °C guarantee resistance to washing in the dishwasher and to chipping.*

design

Zwraca uwagę ręcznym wykonaniem i modnym designem, w którym ponadczasowość przenika się z awangardą. Wszystkie elementy porcelany Verlo zostały stworzone z myślą o wyjątkowych chwilach radości i celebrowania wspólnie spędzanego czasu.

design: *It draws attention with its hand-crafted workmanship and fashionable design, in which timelessness meets the avant-garde. All the elements of Verlo porcelain have been created for exceptional moments of joy and celebration of the time spent together.*



HAND • FINISHED



REACTIVE GLAZE

Wyrafinowane elementy porcelany Verlo wykończonej szkliwem reaktywnym posiadają różne odcienie i niepowtarzalne wzory.

The refined elements of Verlo porcelain finished with reactive glaze have different shades and unique patterns.



Wytwarzane tą metodą kolekcje mają podobny charakter i pasują do siebie. Wszystkie elementy tworzą jedną spójną kompozycję, która w oryginalny sposób zdobi stoły restauracyjne i domowe.

The collections produced by this method have a similar character and match each other. All elements create one coherent composition that decorates restaurant and home tables in an original way.



KUP ON-LINE





N

Talerz płaski
Flat plate

Nr kat.	Ø cm	op.	PLN	EUR
V-90001-4	21	4	29,25	-
V-90002-4	28	4	44,25	-



N

Talerz płaski
Flat plate

Nr kat.	Ø cm	h cm	op.	PLN	EUR
V-90005-4	20,5	4,5	4	42,00	-



N

Talerz głęboki
Deep plate

Nr kat.	Ø cm	cap ml	op.	PLN	EUR
V-90009-2	30	850	2	72,00	-



N

Miska
Bowl

Nr kat.	Ø cm	cap ml	op.	PLN	EUR
V-90015-4	21	1000	4	40,50	-



N

Miseczka
Bowl

Nr kat.	Ø cm	h cm	cap ml	op.	PLN	EUR
V-90003-6	11,2	5,5	250	6	19,50	-
V-90004-4	13,3	4,9	300	4	25,50	-



N

Talerz owalny / półmisek
Oval plate / Dish

Nr kat.	l cm	h cm	w cm	op.	PLN	EUR
V-90017-4	34,8	2,1	14,8	4	43,50	-



N

Talerz płaski
Flat plate

Nr kat.	Ø cm	op.	PLN	EUR
V-90101-4	28,2	4	50,15	-



N

Talerz płaski
Flat plate

Nr kat.	Ø cm	h cm	op.	PLN	EUR
V-90104-4	20,5	4,5	4	47,60	-



N

Talerz głęboki
Deep plate

Nr kat.	Ø cm	cap ml	op.	PLN	EUR
V-90105-2	25,2	800	2	61,20	-



N

Miseczka
Bowl

Nr kat.	Ø cm	cap ml	op.	PLN	EUR
V-90106-4	15,2	450	4	30,60	-



N

Miseczka
Bowl

Nr kat.	Ø cm	cap ml	op.	PLN	EUR
V-90102-6	11,2	300	6	22,10	-
V-90103-4	13,3	350	4	28,90	-





N

Talerz płaski
Flat plate

Nr kat.	Ø cm	op.	PLN	EUR
V-92008-12	15,3	12	11,40	-
V-92004-12	19,4	12	13,86	-
V-92001-12	26,7	12	24,45	-



N

Talerz płaski
Flat plate

Nr kat.	Ø cm	op.	PLN	EUR
V-92007-12	20,5	12	19,56	-
V-92005-12	26,7	12	24,45	-
V-92006-6	30	12	64,39	-



N

Talerz głęboki
Deep plate

Nr kat.	Ø cm	cap ml	op.	PLN	EUR
V-92002-12	23	1020	12	27,71	-



N

Miseczka
Bowl

Nr kat.	Ø cm	cap ml	op.	PLN	EUR
V-92003-12	15,5	640	12	19,56	-





N

Talerz płaski
Flat plate

Nr kat.	Ø cm	op.	PLN	EUR
V-98007-6	16	6	24,45	-
V-98006-6	21	6	30,16	-
V-98005-4	28,5	4	46,45	-



N

Talerz płaski
Flat plate

Nr kat.	Ø cm	op.	PLN	EUR
V-98009-3	22,3	3	48,09	-



N

Talerzyk
Plate

Nr kat.	Ø cm	op.	PLN	EUR
V-98010-12	10	12	11,41	-



N

Talerz głęboki
Deep plate

Nr kat.	Ø cm	cap ml	op.	PLN	EUR
V-98008-4	20	1000	4	43,20	-



N

Kubek
Mug

Nr kat.	Ø cm	h cm	cap ml	op.	PLN	EUR
V-98001-6	7,6	11	250	6	16,30	-

Spodek do kubka
Saucer for cup

N

Nr kat.	Ø cm	op.	PLN	EUR
V-98003-6	14,3	6	16,30	-



N

Filiżanka do espresso
Espresso cup

Nr kat.	Ø cm	h cm	cap ml	op.	PLN	EUR
V-98002-6	5,5	8	90	6	13,04	-

Spodek do filiżanki do espresso
Saucer for espresso cup

N

Nr kat.	Ø cm	op.	PLN	EUR
V-98004-6	12,1	6	13,04	-





N

Talerz płaski
Flat plate

Nr kat.	Ø cm	op.	PLN	EUR
V-93002-6	21	6	30,16	-
V-93001-4	28,5	4	46,45	-



N

Talerz głęboki
Deep plate

Nr kat.	Ø cm	cap ml	op.	PLN	EUR
V-93003-4	21	1100	4	46,45	-

SIMPLY



N

Talerz płaski
Flat plate

Nr kat.	Ø cm	op.	PLN	EUR
V-94002-6	20,5	4	30,16	-
V-94001-4	26,2	4	44,83	-

KUP ON-LINE





N

Talerz płaski
Flat plate

Nr kat.	Ø cm	op.	PLN	EUR
V-17009-12	16,2	12	16,30	-
V-17012-6	23	6	31,79	-
V-17013-4	27	4	52,98	-
V-17014-4	32	4	67,64	-



N

Talerz płaski
Flat plate

Nr kat.	Ø cm	op.	PLN	EUR
V-17010-12	16,2	12	20,38	-
V-17011-6	23	6	39,94	-



N

Talerz głęboki
Deep plate

Nr kat.	Ø cm	cap ml	op.	PLN	EUR
V-17015-6	25,5	310	6	57,05	-



N

Talerz głęboki
Deep plate

Nr kat.	Ø cm	cap ml	op.	PLN	EUR
V-17018-3	29,3	450	3	72,53	-



N

Misa
Bowl

Nr kat.	Ø cm	cap ml	op.	PLN	EUR
V-17016-8	16,5	450	8	26,08	-





Filizanka do espresso
Espresso cup



Nr kat.	Ø cm	h cm	cap ml	op.	PLN	EUR
V-17006-12	5,8	6	90	12	11,90	-



Filizanka do espresso
Espresso cup



Nr kat.	Ø cm	h cm	cap ml	op.	PLN	EUR
V-17005-12	5,8	6	90	12	13,86	-

Spodek do filiżanki do espresso
Saucer for espresso cup



Nr kat.	Ø cm	op.	PLN	EUR
V-17008-12	12,5	12	10,60	-

Spodek do filiżanki do espresso
Saucer for espresso cup



Nr kat.	Ø cm	op.	PLN	EUR
V-17007-12	12,5	12	13,04	-



Filizanka
Cup



Nr kat.	Ø cm	h cm	cap ml	op.	PLN	EUR
V-17002-6	8,4	6	230	6	17,93	-

Spodek do filiżanki
Cup saucer



Nr kat.	Ø cm	h cm	op.	PLN	EUR
V-17004-12	15,8	12	12	13,04	-



Filizanka
Cup



Nr kat.	Ø cm	h cm	cap ml	op.	PLN	EUR
V-17001-6	8,4	6	230	6	22,00	-

Spodek do filiżanki
Cup saucer



Nr kat.	Ø cm	h cm	op.	PLN	EUR
V-17003-12	15,8	12	12	16,30	-



Mlecznik
Milk jug

Nr kat.	cap ml	op.	PLN	EUR
V-17017-12	50	12	13,04	-





Talerz płaski
Flat plate

Nr kat.	Ø cm	op.	PLN	EUR
V-97001-3	22,3	3	48,90	-



Talerz głęboki
Deep plate

Nr kat.	Ø cm	cap ml	op.	PLN	EUR
V-97003-4	23	1100	4	52,16	-
V-97002-4	26,5	1500	4	69,28	-



Miseczka
Bowl

Nr kat.	Ø cm	cap ml	op.	PLN	EUR
V-97004-12	13	180	12	18,75	-



Talerz płaski
Flat plate

Nr kat.	Ø cm	op.	PLN	EUR
V-96002-4	21	4	31,79	-
V-96001-4	28,7	4	52,16	-



Talerz głęboki
Deep plate

Nr kat.	Ø cm	cap ml	op.	PLN	EUR
V-96003-4	20	1000	4	46,45	-



Talerzyk; kamionka
Small plate; stoneware

Nr kat.	Ø cm	op.	PLN	EUR
V-91300-12	9	12	7,33	-



Talerz płaski; kamionka
Flat plate; stoneware

Nr kat.	Ø cm	op.	PLN	EUR
V-913002-6	20	6	25,27	-



Talerz płaski; kamionka
Flat plate; stoneware

Nr kat.	Ø cm	op.	PLN	EUR
V-913001-4	27,3	4	34,23	-





N

Talerz płaski
Flat plate

Nr kat.	Ø cm	op.	PLN	EUR
V-85015-12	12	12	9,75	-
V-85016-6	18,2	6	21,95	-
V-85018-6	20,6	6	24,45	-
V-85019-6	25,7	6	39,02	-
V-85020-4	28,4	4	40,50	-



N

Talerz płaski
Flat plate

Nr kat.	Ø cm	op.	PLN	EUR
V-85017-6	18,2	6	21,95	-



N

Miska
Bowl

Nr kat.	Ø cm	cap ml	op.	PLN	EUR
V-85021-4	18,4	800	4	28,46	-
V-85022-4	23,2	1200	4	51,00	-



N

Misczka
Bowl

Nr kat.	Ø cm	cap ml	op.	PLN	EUR
V-85028-6	10,5	200	6	12,45	-



N

Misczka
Bowl

Nr kat.	Ø cm	cap ml	op.	PLN	EUR
V-85027-6	10,5	200	6	12,45	-





Talerz owalny
Oval plate

Nr kat.	l cm	w cm	op.	PLN	EUR
V-85024-6	26,7	13,9	6	31,71	-
V-85025-6	34,4	17,9	6	43,95	-
V-85026-4	43,2	22,4	4	64,50	-



Talerz owalny
Oval plate

Nr kat.	l cm	w cm	op.	PLN	EUR
V-85023-6	26,7	13,9	6	31,71	-



Filiżanka
Cup

Nr kat.	Ø cm	h cm	cap ml	op.	PLN	EUR
V-85035-12	6,5	4,5	100	12	11,55	-
V-85031-6	7,5	6	140	6	13,13	-



Filiżanka
Cup

Nr kat.	Ø cm	h cm	cap ml	op.	PLN	EUR
V-85037-12	6,5	4,5	100	12	11,55	-
V-85033-6	7,5	6	140	6	13,13	-

Spodek do filiżanki
Cup saucer

Nr kat.	Ø cm	op.	PLN	EUR
V-85036-12	10,3	12	11,55	-
V-85032-12	13,9	12	13,13	-



Spodek do filiżanki
Cup saucer

Nr kat.	Ø cm	op.	PLN	EUR
V-85038-12	10,3	12	11,55	-
V-85034-12	13,9	12	13,13	-



Kubek
Mug

Nr kat.	Ø cm	h cm	cap ml	op.	PLN	EUR
V-85030-6	7,7	8,3	280	6	16,26	-



Mlecznik
Milk jug

Nr kat.	cap ml	op.	PLN	EUR
V-85029-6	90	6	13,01	-



N

Talerz płaski
Flat plate

Nr kat.	Ø cm	op.	PLN	EUR
V-88102-6	20,5	6	30,16	-
V-88101-4	26,2	4	44,83	-



N

Talerz płaski
Flat plate

Nr kat.	Ø cm	op.	PLN	EUR
V-88104-6	20,5	6	30,16	-
V-88103-4	29	4	48,09	-



N

Talerz głęboki
Deep plate

Nr kat.	Ø cm	cap ml	op.	PLN	EUR
V-88106-2	29	250	2	89,65	-



N

Talerz głęboki
Deep plate

Nr kat.	Ø cm	cap ml	op.	PLN	EUR
V-88105-4	20,4	250	4	39,12	-



N

Miska
Bowl

Nr kat.	Ø cm	cap ml	op.	PLN	EUR
V-88107-6	15,4	500	6	30,97	-





N

Talerz płaski
Flat plate

Nr kat.	Ø cm	op.	PLN	EUR
V-91401-4	22	4	38,30	-
V-91400-4	28	4	47,27	-



N

Talerz głęboki
Deep plate

Nr kat.	Ø cm	cap ml	op.	PLN	EUR
V-91402-4	21	645	4	53,79	-



N

Miseczka
Bowl

Nr kat.	Ø cm	h cm	cap ml	op.	PLN	EUR
V-91403-6	12,3	4,8	270	6	23,64	-



N

Miseczka
Bowl

Nr kat.	Ø cm	h cm	cap ml	op.	PLN	EUR
V-91404-6	15	4,8	410	6	28,52	-





N

Talerz płaski
Flat plate

Nr kat.	Ø cm	op.	PLN	EUR
V-91001-6	18	6	22,82	-
V-91002-6	28	6	48,09	-



N

Talerz głęboki
Deep plate

Nr kat.	Ø cm	cap ml	op.	PLN	EUR
V-91005-6	22	800	6	40,75	-



N

Półmisek
Oval plate

Nr kat.	l cm	w cm	op.	PLN	EUR
V-91004-6	17	33,5	6	56,23	-
V-91003-6	18,2	13,6	6	40,75	-



N

Miseczka
Bowl

Nr kat.	Ø cm	cap ml	op.	PLN	EUR
V-91006-4	15,5	400	4	28,52	-





N

Talerz płaski
Flat plate

Nr kat.	Ø cm	op.	PLN	EUR
V-91200-6	21,6	6	27,71	-
V-91201-4	27	4	38,30	-



N

Talerz głęboki
Deep plate

Nr kat.	Ø cm	cap ml	op.	PLN	EUR
V-91202-4	23	990	4	41,56	-



N

Bulionówka
Creamsoup bowl

Nr kat.	Ø cm	h cm	cap ml	op.	PLN	EUR
V-91203-4	15	6,8	690	4	32,60	-



N

Misa
Bowl

Nr kat.	Ø cm	h cm	cap ml	op.	PLN	EUR
V-91204-4	14,2	6,2	550	4	24,45	-





Talerz płaski
Flat plate

Nr kat.	Ø cm	op.	PLN	EUR
V-80401-4	21	4	31,50	-
V-80402-4	28,5	4	49,50	-
V-80403-4	31	4	52,50	-



Talerz głęboki
Deep plate

Nr kat.	Ø cm	cap ml	op.	PLN	EUR
V-80404-3	28	370	3	66,00	-



Talerz głęboki
Deep plate

Nr kat.	Ø cm	cap ml	op.	PLN	EUR
V-80407-4	21,5	500	4	39,00	-



Misa
Bowl

Nr kat.	Ø cm	cap ml	op.	PLN	EUR
V-80405-6	15	500	6	28,50	-
V-80406-4	20	900	4	42,00	-



Filizanka
Cup

Nr kat.	Ø cm	h cm	cap ml	op.	PLN	EUR
V-80408-6	6,7	5,2	90	6	14,25	-
V-80410-6	9,2	6,5	210	6	21,00	-

Spodek do filizanki
Cup saucer

Nr kat.	Ø cm	op.	PLN	EUR
V-80409-6	12	6	13,50	-
V-80411-6	15,2	6	16,50	-



N

Talerz płaski
Flat plate

Nr kat.	Ø cm	op.	PLN	EUR
V-80501-4	26,6	4	46,50	-



N

Talerz głęboki
Deep plate

Nr kat.	Ø cm	cap ml	op.	PLN	EUR
V-80502-2	28	500	2	58,50	-



N

Ramekin / Miska
Ramekin / Bowl

Nr kat.	Ø cm	cap ml	op.	PLN	EUR
V-80510-12	6,8	100	12	10,50	-
V-80509-4	12	350	4	22,50	-



N

Filizanka
Cup

Nr kat.	Ø cm	h cm	cap ml	op.	PLN	EUR
V-80503-8	8,2	5,2	90	8	12,00	-
V-80504-6	10,5	6,7	200	6	18,00	-

Spodek do filizanki
Cup saucer

N

Nr kat.	Ø cm	op.	PLN	EUR
V-80505-8	13	8	10,50	-
V-80506-8	15	8	15,00	-



N

Mlecznik
Milk jug

Nr kat.	h cm	cap ml	op.	PLN	EUR
V-80508-6	7,7	100	6	16,50	-
V-80507-6	10	280	6	21,00	-





N

Talerz płaski
Flat plate

Nr kat.	Ø cm	op.	PLN	EUR
V-90205-4	21	4	30,00	-
V-90204-4	25	4	40,50	-



N

Talerz płaski
Flat plate

Nr kat.	Ø cm	op.	PLN	EUR
V-90203-4	20,6	4	47,60	-



N

Talerz płaski
Flat plate

Nr kat.	Ø cm	op.	PLN	EUR
V-90216-4	28,2	4	43,50	-



N

Talerz płaski
Flat plate

Nr kat.	Ø cm	op.	PLN	EUR
V-90215-4	24	4	52,50	-



N

Talerz głęboki
Deep plate

Nr kat.	Ø cm	cap ml	op.	PLN	EUR
V-90206-2	25	800	2	48,00	-



N

Półmisek
Rectangular dish

Nr kat.	l cm	w cm	op.	PLN	EUR
V-90210-6	25	13	6	30,00	-





N

Miska
Bowl

Nr kat.	Ø cm	cap ml	op.	PLN	EUR
V-90207-4	15,2	500	4	27,00	-



N

Miseczka
Bowl

Nr kat.	Ø cm	cap ml	op.	PLN	EUR
V-90201-6	11,2	300	6	22,10	-
V-90202-4	13,3	350	4	28,90	-



N

Mlecznik
Milk jug

Nr kat.	cap ml	op.	PLN	EUR
V-90213-12	60	12	9,00	-



N

Mlecznik
Milk jug

Nr kat.	l cm	h cm	w cm	cap ml	op.	PLN	EUR
V-90214-12	14	6,5	4	100	12	19,50	-



N

Czajniczek do herbaty
Tea pot

Nr kat.	cap ml	op.	PLN	EUR	
V-90209-1	450	1	54,00	-	
V-90209LD-12	pokrywka zapasowa		12	10,50	-



N

Kubek
Mug

Nr kat.	Ø cm	h cm	cap ml	op.	PLN	EUR
V-90208-4	9	8,1	320	4	18,00	-



Talerz płaski
Flat plate

Nr kat.	Ø cm	op.	PLN	EUR
V-91102-4	20	4	26,89	-
V-91101-4	28	4	38,30	-



Talerz głęboki
Deep plate

Nr kat.	Ø cm	cap ml	op.	PLN	EUR
V-91100-4	23	1440	4	38,30	-



Misa
Bowl

Nr kat.	Ø cm	h cm	cap ml	op.	PLN	EUR
V-91103-4	15	6	720	4	26,89	-



Kubek
Mug

Nr kat.	Ø cm	h cm	cap ml	op.	PLN	EUR
V-91500-4	9,9	8,7	420	4	22,00	-



Talerz
Plate

Nr kat.	l cm	h cm	w cm	op.	PLN	EUR
V-95001-2	24,5	5,3	19	2	70,09	-



Talerz płaski
Flat plate

Nr kat.	Ø cm	op.	PLN	EUR
V-80102-6	18	6	26,43	-
V-80101-6	25	6	47,55	-
V-80100-3	30	3	63,51	-

IRON  HAND-FINISHED



Talerz płaski
Flat plate

Nr kat.	Ø cm	op.	PLN	EUR
V-80305-6	21	6	31,75	-
V-80306-3	30	3	63,51	-



Talerz głęboki
Deep plate

Nr kat.	Ø cm	cap ml	op.	PLN	EUR
V-80304-6	20,5	600	6	29,93	-
V-80307-6	26	1500	6	44,89	-



Miska
Bowl

Nr kat.	Ø cm	cap ml	op.	PLN	EUR
V-80300-6	18	1000	6	33,25	-



Brytfanna
Baking tray

Nr kat.	Ø cm	cap ml	op.	PLN	EUR
V-80302-1	26	1200	1	67,00	-



Brytfanna
Baking tray

Nr kat.	l cm	w cm	cap ml	op.	PLN	EUR
V-80303-1	33	22	2300	1	98,75	-



Ramekin z uchwytami
Ramekin with handle

Nr kat.	Ø cm	cap ml	op.	PLN	EUR
V-80301-6	8	130	6	14,96	-



Miska
Bowl

Nr kat.	Ø cm	cap ml	op.	PLN	EUR
V-84000-3	20	1800	3	51,73	-
V-84002-3	25,5	3400	3	75,81	-



Miska
Bowl

Nr kat.	Ø cm	cap ml	op.	PLN	EUR
V-84001-3	20	1800	3	39,84	-
V-84003-3	25,5	3400	3	60,16	-



N

Patera
Plateau

Nr kat.	Ø cm	h cm	PLN	EUR
V-84004-1	30	10,5	119,00	-



N

Dzbanek
Jug

Nr kat.	cap ml	op.	PLN	EUR
V-84005-2	1330	2	88,20	-





Talerz płaski
Flat plate

Nr kat.	Ø cm	op.	PLN	EUR
V-89002-6	15	6	14,13	-
V-89000-6	21	6	29,93	-
V-89001-6	25	6	47,55	-
N V-89008-3	30	3	65,04	-

Talerz płaski
Flat plate

Nr kat.	Ø cm	op.	PLN	EUR
V-89009-4	28,5	4	50,41	-



Talerz głęboki
Deep plate

Nr kat.	Ø cm	cap ml	op.	PLN	EUR
V-89010-2	28,5	400	2	63,41	-



Miska
Bowl

Nr kat.	Ø cm	cap ml	op.	PLN	EUR
V-89012-24	9,5	100	24	10,50	-
V-89011-6	15	500	6	27,00	-



N

Czajniczek do kawy/herbaty
Coffee / tea pot

Nr kat.	h cm	cap ml	op.	PLN	EUR
V-89014-2	14	500	2	45,00	-
V-89014LD-12			12	13,50	-

*pokrywa
zapasowa*



N

Kubek
Mug

Nr kat.	Ø cm	h cm	cap ml	op.	PLN	EUR
V-89013-4	7,8	10,5	330	4	24,00	-



Filiżanka
Cup

Nr kat.	Ø cm	h cm	cap ml	op.	PLN	EUR
V-89003-12	6	6	80	12	12,30	-
V-89005-6	8	7	200	6	17,62	-

Spodek do filiżanki
Cup saucer

Nr kat.	Ø cm	op.	PLN	EUR
V-89004-8	12	8	12,30	-
V-89006-8	13,5	8	14,13	-



Kubek
Cup

Nr kat.	Ø cm	h cm	cap ml	op.	PLN	EUR
V-89007-6	8	9	250	6	22,11	-





V-80207-6 | V-80200-4

V-80206-4

V-80207-6 | V-80200-4

V-80206-4

Talerz płaski Flat plate

Nr kat.	Ø cm	op.	PLN	EUR
V-80207-6	21	6	29,93	-
V-80200-4	25,5	4	43,23	-
V-80206-4	28,5	4	46,55	-



Talerz głęboki Deep plate

Nr kat.	Ø cm	cap ml	op.	PLN	EUR
V-80204-6	26	1500	6	44,89	-



Talerz głęboki Deep plate

Nr kat.	Ø cm	cap ml	op.	PLN	EUR
V-80205-2	28,5	400	2	61,51	-



Miska Bowl

Nr kat.	Ø cm	cap ml	op.	PLN	EUR
V-80203-12	11,5	200	12	14,96	-



Brytfanna Baking tray

Nr kat.	Ø cm	cap ml	op.	PLN	EUR
V-80201-2	20	600	2	47,55	-



Ramekin z uchwytami Ramekin with handle

Nr kat.	Ø cm	cap ml	op.	PLN	EUR
V-80202-6	9,5	200	6	21,61	-





Bulionówka
Creamsoup bowl

Nr kat.	Ø cm	h cm	cap ml	op.	PLN	EUR
V-80213-6	12	5,2	320	6	25,50	-

Spodek do bulionówki
Saucer for creamsoup bowl

Nr kat.	Ø cm	op.	PLN	EUR
V-80211-8	13	8	13,50	-



Filiżanka do espresso
Espresso cup

Nr kat.	Ø cm	h cm	cap ml	op.	PLN	EUR
V-80208-8	6	5,5	90	8	12,00	-

Spodek do filiżanki do espresso
Saucer for espresso cup

Nr kat.	Ø cm	op.	PLN	EUR
V-80210-8	15	8	10,50	-



Kubek
Mug

Nr kat.	Ø cm	h cm	cap ml	op.	PLN	EUR
V-80212-6	9	10,2	380	6	19,50	-



Czajniczek do kawy/herbaty
Coffee / tea pot

Nr kat.	cap ml	op.	PLN	EUR
V-80214-2	500	2	45,00	-
V-80214LD-12	<i>pokrywka zapasowa</i>	12	10,50	-



Filiżanka do kawy
Coffee cup

Nr kat.	Ø cm	h cm	cap ml	op.	PLN	EUR
V-80209-6	8,2	7,5	230	6	15,90	-

Spodek do filiżanki do kawy
Saucer for coffee cup

Nr kat.	Ø cm	op.	PLN	EUR
V-80211-8	13	8	13,50	-



Mlecznik
Milk jug

Nr kat.	cap ml	op.	PLN	EUR
V-80215-12	90	12	13,50	-



Talerz płaski
Flat plate

Nr kat.	Ø cm	op.	PLN	EUR
N V-88007-6	20	6	39,12	-
V-88003-4	25	4	49,38	-
V-88004-2	29	2	59,85	-



Talerz głęboki
Deep plate

Nr kat.	Ø cm	cap ml	op.	PLN	EUR
V-88002-2	24	1200	2	61,68	-



Miska
Bowl

Nr kat.	Ø cm	cap ml	op.	PLN	EUR
V-88001-4	23	1000	4	63,51	-



Miska
Bowl

Nr kat.	Ø cm	cap ml	op.	PLN	EUR
V-88005-6	15	600	6	29,93	-



Półmisek
Oval plate

Nr kat.	l cm	w cm	op.	PLN	EUR
V-88000-6	30	10	6	38,74	-

KUP ON-LINE 

Filiżanka
Cup

N

Nr kat.	Ø cm	h cm	cap ml	op.	PLN	EUR
V-88008-6	8,3	7	90	6	16,50	-
V-88009-8	10,5	8,8	200	8	17,25	-



Filiżanka
Cup

Nr kat.	Ø cm	h cm	cap ml	op.	PLN	EUR
V-88006-6	7,5	9	200	6	14,96	-

Spodek do filiżanki
Cup saucer

N

Nr kat.	Ø cm	op.	PLN	EUR
V-88010-8	13	8	10,50	-
V-88011-8	15	8	13,50	-



Talerz płaski
Flat plate

Nr kat.	Ø cm	op.	PLN	EUR
V-83006-6	25	6	47,55	-



Talerz płaski
Flat plate

Nr kat.	Ø cm	op.	PLN	EUR
V-83003-4	28	4	56,43	-



Talerz płaski
Flat plate

Nr kat.	Ø cm	op.	PLN	EUR
V-83004-4	28,5	4	58,33	-



Talerz głęboki
Deep plate

Nr kat.	Ø cm	cap ml	op.	PLN	EUR
V-83005-3	29,2	440	3	61,68	-



Talerz głęboki
Deep plate

Nr kat.	Ø cm	cap ml	op.	PLN	EUR
V-83000-6	26	900	6	56,43	-



Talerz płaski
Flat plate

Nr kat.	l cm	w cm	op.	PLN	EUR
V-83002-4	33	18	4	49,38	-



Misa
Bowl

Nr kat.	Ø cm	cap ml	op.	PLN	EUR
V-83001-1	30,5	2600	1	142,69	-



Brytfanna
Baking tray

Nr kat.	l cm	w cm	cap ml	op.	PLN	EUR
V-83008-1	26	16	1000	1	52,87	-





Brytfanna
Baking tray

Nr kat.	Ø cm	cap ml	op.	PLN	EUR
V-83007-4	15	270	4	31,75	-



Ramekin z uchwytyami
Ramekin with handle

Nr kat.	Ø cm	cap ml	op.	PLN	EUR
V-83009-6	9,5	250	6	21,61	-



Bulionówka
Creamsoup bowl

Nr kat.	Ø cm	h cm	cap ml	op.	PLN	EUR
V-83014-6	12	5,2	320	6	25,50	-

N



Filiżanka
Cup

Nr kat.	Ø cm	h cm	cap ml	op.	PLN	EUR
V-83010-8	6	5	90	8	12,00	-
V-83011-6	7,8	6,5	200	6	18,00	-

N

Spodek do filiżanki
Cup saucer

Nr kat.	Ø cm	op.	PLN	EUR
V-83012-8	13	8	10,50	-
V-83013-8	15	8	13,50	-

N





Talerz płaski
Flat plate

Nr kat.	Ø cm	op.	PLN	EUR
V-82020-6	20,5	6	24,94	-
V-82019-4	26	4	41,56	-

Talerz płaski
Flat plate

Nr kat.	Ø cm	op.	PLN	EUR
V-82012-6	18	6	26,43	-
V-82013-6	25	6	47,55	-
N V-82027-3	30	3	65,04	-

Talerz głęboki
Deep plate

Nr kat.	Ø cm	cap ml	op.	PLN	EUR
V-82018-3	26	1000	3	46,55	-



Talerz płaski
Flat plate

Nr kat.	Ø cm	op.	PLN	EUR
V-82008-4	28,5	4	56,43	-

Miska
Bowl

Nr kat.	Ø cm	cap ml	op.	PLN	EUR
V-82021-4	18	1000	4	39,90	-

Talerz głęboki
Deep plate

Nr kat.	Ø cm	cap ml	op.	PLN	EUR
V-82009-3	28,5	400	3	61,68	-



Talerz głęboki
Deep plate

Nr kat.	Ø cm	cap ml	op.	PLN	EUR
V-82006-4	23,5	1200	4	56,36	-
V-82007-2	26	1500	2	68,66	-

Miska
Bowl

Nr kat.	l cm	w cm	cap ml	op.	PLN	EUR
V-82015-6	14,5	13	300	6	26,43	-
V-82016-3	22	20	1200	3	61,68	-
V-82017-3	25	23	2000	3	102,24	-

Miska
Bowl

Nr kat.	Ø cm	cap ml	op.	PLN	EUR
V-82005-4	18	800	4	36,34	-





Misa
Bowl

Nr kat.	Ø cm	cap ml	op.	PLN	EUR
V-82002-2	24,5	1600	2	58,33	-



Misa
Bowl

Nr kat.	Ø cm	cap ml	op.	PLN	EUR
V-82003-1	29,5	2100	1	84,55	-
V-82004-1	34	3800	1	151,62	-



Misa bufetowa
Buffet bowl

Nr kat.	Ø cm	cap ml	op.	PLN	EUR
V-82000-2	25	600	2	90,63	-
V-82001-1	30,5	1700	1	157,13	-



Półmisek
Rectangular dish

Nr kat.	l cm	w cm	op.	PLN	EUR
V-82010-6	30,5	14	6	56,43	-
V-82011-4	35,5	16,5	4	72,58	-



Bulionówka
Creamsoup bowl

Nr kat.	Ø cm	h cm	cap ml	op.	PLN	EUR
V-82032-6	12	5,4	320	6	25,50	-

Spodek do bulionówki
Saucer for creamsoup bowl

Nr kat.	Ø cm	op.	PLN	EUR
V-82036-6	15	6	15,00	-



Ramekin
Ramekin

Nr kat.	Ø cm	h cm	cap ml	op.	PLN	EUR
V-82031-12	8,4	3	100	12	10,50	-



Ramekin
Ramekin

Nr kat.	l cm	w cm	cap ml	op.	PLN	EUR
V-82014-6	8,5	7,5	60	6	12,30	-





N

Czajniczek do kawy/herbaty
Coffee / tea pot

Nr kat.	cap ml	op.	PLN	EUR
V-82028-2	500	2	45,00	-
V-82028LD-12	<i>pokrywka zapasowa</i>	12	13,50	-
V-82029-2	1000	2	70,50	-
V-82029LD-12	<i>pokrywka zapasowa</i>	12	18,00	-



Filizanka
Cup

N

Nr kat.	Ø cm	h cm	cap ml	op.	PLN	EUR
V-82033-12	8	5	90	12	12,00	-
V-82034-6	10	9,1	200	6	18,00	-

Spodek
Cup saucer

N

Nr kat.	Ø cm	op.	PLN	EUR
V-82035-8	13	8	10,50	-
V-82036-6	15	6	15,00	-



Filizanka do espresso
Espresso cup

Nr kat.	Ø cm	h cm	cap ml	op.	PLN	EUR
V-82022-6	6	6	90	6	11,64	-



Filizanka do kawy
Coffee cup

Nr kat.	Ø cm	h cm	cap ml	op.	PLN	EUR
V-82025-6	10	5	210	6	16,63	-



Kubek
Mug

Nr kat.	Ø cm	h cm	cap ml	op.	PLN	EUR
V-82024-6	9	9	350	6	21,61	-

Spodek do filizanki do espresso
Saucer for espresso cup

Nr kat.	Ø cm	op.	PLN	EUR
V-82023-12	11,5	12	9,98	-

Spodek do filizanki do kawy
Saucer for coffee cup

Nr kat.	Ø cm	op.	PLN	EUR
V-82026-12	15	12	11,64	-



N

Cukiernica
Sugar bowl

Nr kat.	cap ml	op.	PLN	EUR
V-82037-6	220	6	19,50	-
V-82037LD-12	<i>pokrywka zapasowa</i>	12	13,50	-



N

Mlecznik
Milk jug

Nr kat.	h cm	cap ml	op.	PLN	EUR
V-82030-6	15,5	400	6	29,25	-





Talerz płaski
Flat plate

Nr kat.	Ø cm	op.	PLN	EUR
V-81005-6	25	6	61,35	-



Talerz
Plate

Nr kat.	Ø cm	cap ml	op.	PLN	EUR
V-81003-6	21,5	820	6	49,21	-
V-81004-6	24,5	1400	6	59,09	-



Misa
Bowl

Nr kat.	Ø cm	cap ml	op.	PLN	EUR
V-81001-6	15,5	630	6	33,56	-
V-81002-6	20	1400	6	55,36	-





Talerz płaski
Flat plate

Nr kat.	Ø cm	op.	PLN	EUR
V-86001-6	23	6	26,13	-
V-86002-6	26	6	32,66	-



Miska
Bowl

Nr kat.	Ø cm	cap ml	op.	PLN	EUR
V-86000-4	10	200	4	10,07	-



Talerz głęboki
Deep plate

Nr kat.	Ø cm	cap ml	op.	PLN	EUR
V-86004-4	23,5	1400	4	43,94	-



Miska
Bowl

Nr kat.	Ø cm	cap ml	op.	PLN	EUR
V-86003-4	16,5	900	4	24,94	-





Talerz płaski
Flat plate

Nr kat.	l cm	w cm	op.	PLN	EUR
V-87002-2	39	31	2	66,26	-



Talerz płaski
Flat plate

Nr kat.	Ø cm	op.	PLN	EUR
V-87001-6	23,5	6	22,09	-



Misa bufetowa
Buffet bowl

Nr kat.	Ø cm	cap ml	op.	PLN	EUR
V-87000-2	26,5	3100	2	94,05	-

KUP ON-LINE





N

Talerz płaski
Flat plate

Nr kat.	Ø cm	op.	PLN	EUR
N V-80012-6	16	6	28,52	-
V-80011-6	21	6	34,23	-
V-80002-4	26	4	43,32	-



Talerz głęboki
Deep plate

Nr kat.	Ø cm	cap ml	op.	PLN	EUR
V-80001-4	23,5	900	4	46,55	-



Misa
Bowl

Nr kat.	Ø cm	cap ml	op.	PLN	EUR
V-80000-4	16,5	800	4	33,25	-
V-80003-1	22	2800	1	97,28	-





Misa
Bowl

Nr kat.	Ø cm	h cm	cap ml	op.	PLN	EUR
V-80009-6	9	4,5	175	6	22,00	-



Misa
Bowl

Nr kat.	Ø cm	cap ml	op.	PLN	EUR
V-80010-6	11,5	300	6	23,64	-



Filizanka
Cup

Nr kat.	cap ml	op.	PLN	EUR
V-80004-6	90	6	14,67	-
V-80006-6	210	6	16,60	-

Spodek do filizanki
Cup saucer

Nr kat.	op.	PLN	EUR
V-80005-6	6	13,04	-
V-80007-6	6	18,75	-



Kubek
Mug

Nr kat.	cap ml	op.	PLN	EUR
V-80008-6	380	6	20,38	-





RAK to doskonały wybór dla profesjonalistów ceniących jakość, trwałość i ponadczasową elegancję. Idealną gładkość glazury, niepowtarzalny, naturalny kolor oraz wysoką odporność doceniło wiele hoteli i restauracji na całym świecie.

RAK is an excellent choice for the professionals who value quality, durability and timeless elegance. Perfect smoothness of the glaze, unique, natural colour and high durability have been appreciated by many hotels and restaurants around the world.

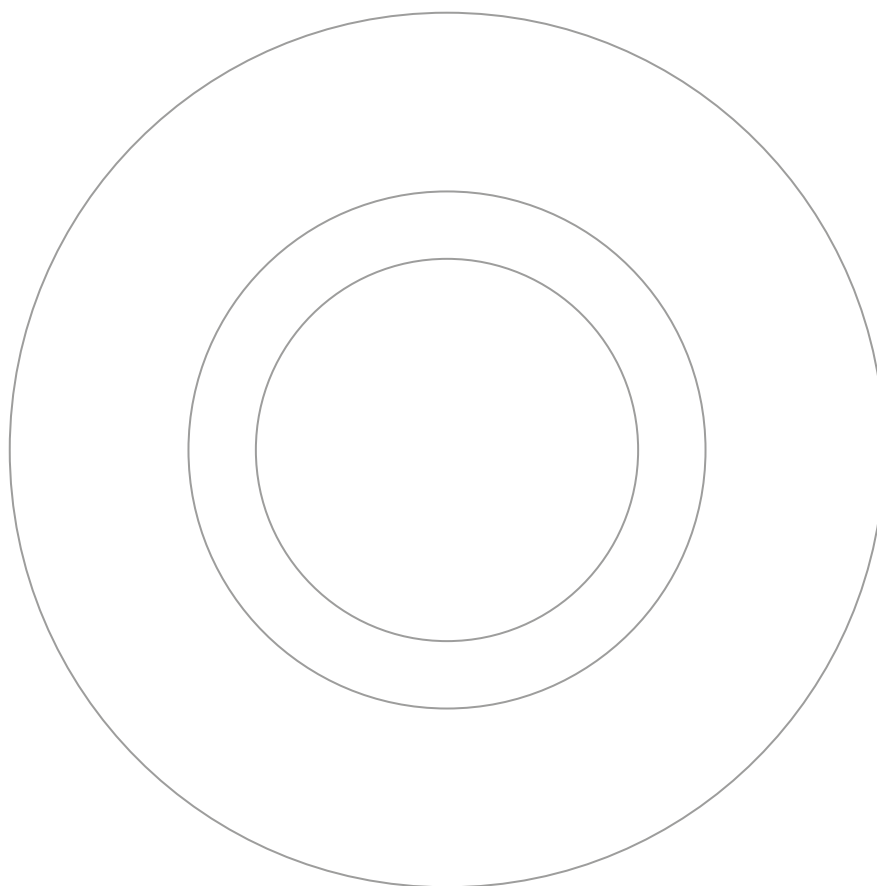

KUP ON-LINE



idealna gładkość

Wykonana z naturalnego, bezolowiowego surowca. Dzięki wykorzystaniu nowoczesnych technologii, posiada idealnie gładką glazurę, która nie pozwala na absorpcję tłuszczu, zapachów czy bakterii.

perfect smoothness: *Made of natural, lead-free raw material. Thanks to the use of modern technologies, it has perfectly smooth glaze, which does not allow the absorption of fat, odours or bacteria.*

odporna

Wyjątkowa twardość i wytrzymałość porcelany RAK zapewnia niezwykłą odporność na szok mechaniczny i termiczny, a także wyszczerbienia.

shock resistance: *Exceptional hardness and strength of RAK porcelain ensures exceptional resistance to mechanical shock and nicks as well as large temperature differences.*



Elementy oznaczone tym symbolem posiadają dożywotnią gwarancję na wyszczerbienia. Jeżeli talerz ulegnie wyszczerbieniu, zostanie wymieniony na nowy.

Items marked with this symbol have a lifetime warranty on nicks. If the plate happens to have a nick, it will be replaced with a new one.



B O N E C H I N A

Wytworna w swej delikatności, cienka i przezierna porcelana Bone China. Dzięki nowoczesnym technologiom tradycyjnie wykorzystywany jako surowiec popiół kostny, został zastąpiony syntetycznymi odpowiednikami. W pełni wegańska wersja stworzona dla miłośników luksusowego stylu.

Exquisite in its fineness, thin and translucent Bone China porcelain. Thanks to modern technologies, the bone ash traditionally used as a raw material has been replaced by synthetic equivalents. A fully vegan version was created for lovers of luxury style.



SPECTRA

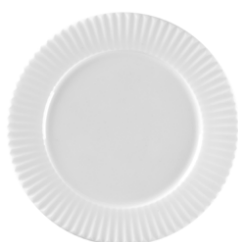

Talerz płaski
Flat plate

Nr kat.	Ø cm	op.	PLN	EUR
R-BCSPFP16-24	16	24	37,20	-
R-BCSPFP22-12	22	12	49,98	-
R-BCSPFP27-12	27	12	71,64	-
R-BCSPFP29-12	29	12	80,10	-
R-BCSPFP31-6	31,5	6	95,94	-
R-BCSPFP33-6	32,5	6	102,25	-

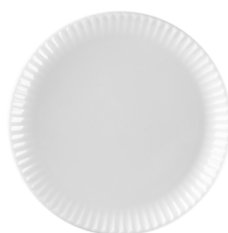

Talerz płaski
Flat plate

Nr kat.	Ø cm	op.	PLN	EUR
R-BCSPCP15-24	15	24	30,24	-
R-BCSPCP21-12	21	12	48,06	-
R-BCSPCP24-12	24	12	51,48	-
R-BCSPCP27-12	27	12	64,74	-
R-BCSPCP29-12	28,5	12	72,48	-



Talerz płaski gourmet
Gourmet flat plate

Nr kat.	Ø cm	op.	PLN	EUR
R-BCSPGF29-12	29	12	92,16	-



Talerz głęboki coupe
Coupe deep plate

Nr kat.	Ø cm	cap ml	op.	PLN	EUR
R-BCSPDC23-12	23	900	12	61,62	-
R-BCSPDC27-12	26,5	1560	12	79,62	-



Talerz głęboki
Deep plate

Nr kat.	Ø cm	cap ml	op.	PLN	EUR
R-BCSPDRP28-12	28	630	12	92,16	-
R-BCSPDP31-6	31	890	6	99,66	-



Talerz głęboki gourmet
Gourmet deep plate

Nr kat.	Ø cm	cap ml	op.	PLN	EUR
R-BCSPGD29-6	29	240	6	92,16	-

KUP ON-LINE





Miska
Bowl

Nr kat.	Ø cm	cap ml	op.	PLN	EUR
R-BCSPBW30-12	11	300	12	26,64	-
R-BCSPBW50-12	13	500	12	36,72	-
R-BCSPBW100-6	17	1000	6	61,98	-



Imbryk
Tea pot

Nr kat.	cap ml	op.	PLN	EUR
R-BCSPCP40-6	480	6	88,80	-



Bulionówka
Creamsoup bowl



Nr kat.	Ø cm	cap ml	op.	PLN	EUR
R-BCSPCS37-12	11,8	370	12	60,66	-

Spodek do bulionówki
Soup bowl saucer



Nr kat.	Ø cm	op.	PLN	EUR
R-BCSPSA18-12	18	12	38,04	-



Kubek
Mug



Nr kat.	Ø cm	h cm	cap ml	op.	PLN	EUR
R-BCSPMG45-12	9,6	9	440	12	46,84	-



Filiżanka do espresso
Espresso cup



Nr kat.	Ø cm	h cm	cap ml	op.	PLN	EUR
R-BCSPCU09-12	6,1	5,5	90	12	26,16	-

Spodek do filiżanki do espresso
Saucer for espresso cup



Nr kat.	Ø cm	op.	PLN	EUR
R-BCSPSA13-12	13	12	19,56	-



Filiżanka
Cup



Nr kat.	Ø cm	h cm	cap ml	op.	PLN	EUR
R-BCSPCU23-12	8,9	6	240	12	42,00	-
R-BCSPCU28-12	9,5	7,5	310	12	43,80	-

Spodek do filiżanki
Cup saucer



Nr kat.	Ø cm	op.	PLN	EUR
R-BCSPSA15-12	15	12	30,42	-
R-BCSPSA17-12	17,3	12	37,20	-



Mlecznik
Milk jug



Nr kat.	cap ml	op.	PLN	EUR
R-BCSPCR25-12	350	12	47,40	-



Cukiernica
Sugar bowl



Nr kat.	Ø cm	cap ml	op.	PLN	EUR
R-BCSPSU22-6	10	280	6	59,04	-





Talerz płaski
Flat plate

Nr kat.	Ø cm	op.	PLN	EUR
R-BCFRCP15-24	15	24	34,83	-
R-BCFRCP24-12	24	12	59,31	-



Talerz płaski
Flat plate

Nr kat.	Ø cm	cap ml	op.	PLN	EUR
R-BCBVDP28-12	28	380	12	84,96	-

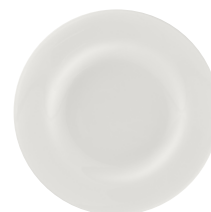

Talerz płaski
Flat plate

Nr kat.	Ø cm	op.	PLN	EUR
R-BCBVFP17-24	17	24	47,61	-
R-BCBVFP23-12	23	12	64,17	-
R-BCBVFP28-12	28	12	91,80	-
R-BCBVFP32-6	32	6	129,42	-



Talerz płaski gourmet
Gourmet flat plate

Nr kat.	Ø cm	op.	PLN	EUR
R-BCFRGF29-12	29	12	106,20	-



Talerz głęboki
Deep plate

Nr kat.	Ø cm	cap ml	op.	PLN	EUR
R-BCBVDG25-12	25	240	12	83,70	-
R-BCBVDG29-6	29	310	6	118,08	-





Talerz głęboki
Deep plate

Nr kat.	Ø cm	cap ml	op.	PLN	EUR
R-BCFRDC23-12	23	900	12	71,10	-
R-BCFRDC27-12	26,5	1560	12	91,80	-



Talerz głęboki gourmet
Gourmet deep plate

Nr kat.	Ø cm	cap ml	op.	PLN	EUR
R-BCFRGD26-6	26	220	6	75,33	-
R-BCFRGD29-6	29	240	6	106,20	-



Miska
Bowl

Nr kat.	Ø cm	cap ml	op.	PLN	EUR
R-BCFRBW30-12	11	300	12	30,69	-
R-BCFRBW75-12	15	780	12	49,59	-
R-BCFRBW100-6	17	1000	6	71,37	-



Kubek bez uchwyu
Cup without handle

Nr kat.	h cm	cap ml	op.	PLN	EUR
R-BCFRCU20M-12	5,5	200	12	39,24	-



Kubek
Mug

Nr kat.	h cm	cap ml	op.	PLN	EUR
R-BCFRMG30-12	8,5	320	12	50,40	-



Filizanka do espresso
Espresso cup

Nr kat.	h cm	cap ml	op.	PLN	EUR
R-BCFRCU09-12	5,5	90	12	29,97	-



Filizanka
Cup

Nr kat.	h cm	cap ml	op.	PLN	EUR
R-BCFRCU23-12	6	240	12	48,42	-

Saucer
Saucer

Nr kat.	Ø cm	op.	PLN	EUR
R-BCFRSA13-12	13	12	22,68	-

Spodek
Saucer

Nr kat.	Ø cm	op.	PLN	EUR
R-BCFRSA15-12	15	12	35,19	-





Kolekcja **EARTH TERO** to hołd dla natury i tradycji. Unikalna paleta kolorów, nawiązuje do korzeni dawnych tradycji garncarstwa. Dzięki specjalnemu procesowi matowego szkliwienia, kolekcja przywodzi na myśl autentyczną terakotę i glinę, zachowując jednocześnie wyjątkową gładkość i wytrzymałość. Każdy zdobiony produkt jest wyjątkowy, gdyż wzory są ręcznie nakładane na powierzchnię naczyń. Ewentualne drobne różnice we wzorach są dowodem na indywidualność każdego elementu.

The **EARTH TERO** collection is a tribute to nature and tradition. A unique color palette, it harks back to the roots of ancient pottery traditions. Thanks to a special matte glazing process, the collection is reminiscent of authentic terracotta and clay, while maintaining exceptional smoothness and strength. Each decorated product is unique, as the patterns are hand-applied to the surface of the vessels. Any slight differences in the patterns are evidence of the individuality of each piece.



Talerz płaski
Flat plate

Nr kat.		Ø cm	op.	PLN	EUR
R-RETLUFP16-24	Prima	15,5	24	47,44	-
R-RETLUFP19-24	Prima	18,5	24	53,91	-
R-RETLUFP21-12	Prima	20,5	12	64,26	-
R-RETLUFP24-12	Prima	23,5	12	83,58	-
R-RETLUFP27-12	Prima	26,5	12	106,78	-
R-RETLUFP29-12	Prima	29	12	139,47	-



Talerz płaski
Flat plate

Nr kat.		Ø cm	op.	PLN	EUR
R-RETLUFP16E02-24	Denia	15,5	24	66,58	-
R-RETLUFP19E02-24	Denia	18,5	24	75,47	-
R-RETLUFP21E02-12	Denia	20,5	12	90,05	-
R-RETLUFP24E02-12	Denia	23,5	12	116,87	-
R-RETLUFP27E02-12	Denia	26,5	12	149,64	-
R-RETLUFP29E02-12	Denia	29	12	195,36	-



Talerz głęboki
Deep plate

Nr kat.		Ø cm	cap ml	op.	PLN	EUR
R-RETLUDP21-12	<i>Prima</i>	20,5	500	12	73,66	-
R-RETLUDP24-12	<i>Prima</i>	23,5	650	12	91,51	-
R-RETLUDP27-12	<i>Prima</i>	27	1050	12	118,68	-

Talerz głęboki
Deep plate

Nr kat.		Ø cm	cap ml	op.	PLN	EUR
R-RETLUDP21E02-12	<i>Denia</i>	20,5	500	12	103,07	-
R-RETLUDP24E02-12	<i>Denia</i>	23,5	650	12	128,08	-
R-RETLUDP27E02-12	<i>Denia</i>	27	1050	12	166,12	-

Filizanka
Cup

Nr kat.		Ø cm	h cm	cap ml	op.	PLN	EUR
R-RETEACU09-12	<i>Prima</i>	6	7	90	12	47,44	-
R-RETEACU20-12	<i>Prima</i>	7	9	200	12	57,27	-
R-RETEACU23-12	<i>Prima</i>	7,5	9	230	12	61,32	-

Filizanka
Cup

Nr kat.		Ø cm	h cm	cap ml	op.	PLN	EUR
R-RETEACU09E02-12	<i>Denia</i>	6	7	90	12	66,58	-
R-RETEACU20E02-12	<i>Denia</i>	7	9	200	12	80,38	-
R-RETEACU23E02-12	<i>Denia</i>	7,5	9	230	12	85,82	-

Spodek do filiżanki
Cup saucer

Nr kat.		Ø cm	op.	PLN	EUR
R-RETANSA13M-12	<i>Prima</i>	13	12	40,54	-

Spodek do filiżanki
Cup saucer

Nr kat.		Ø cm	op.	PLN	EUR
R-RETANSA13ME02-12	<i>Denia</i>	13	12	56,92	-

Kubek
Mug

Nr kat.		Ø cm	h cm	cap ml	op.	PLN	EUR
R-RETEAMG30-12	<i>Prima</i>	8	10	300	12	72,62	-

Kubek
Mug

Nr kat.		Ø cm	h cm	cap ml	op.	PLN	EUR
R-RETEAMG30E02-12	<i>Denia</i>	8	10	300	12	101,78	-

Spodek do kubka
Cup saucer

Nr kat.		Ø cm	op.	PLN	EUR
R-RETANSA15-12	<i>Prima</i>	15	12	49,94	-

Spodek do kubka
Cup saucer

Nr kat.		Ø cm	op.	PLN	EUR
R-RETANSA15E02-12	<i>Denia</i>	15	12	69,95	-





Miska
Bowl

Nr kat.		Ø cm	cap ml	op.	PLN	EUR
R-RETANCB13-6	<i>Prima</i>	13,5	630	6	96,51	-



Miska
Bowl

Nr kat.		Ø cm	cap ml	op.	PLN	EUR
R-RETANCB13E02-6	<i>Denia</i>	13,5	630	6	135,07	-

EARTH BAANTNA TERO



Taca Thali
Tray Thali

Nr kat.		Ø cm	h cm	op.	PLN	EUR
R-RETINTP31-2	<i>Prima</i>	33,5	3,5	2	324,56	-



Mieczka Thali
Bowl Thali

Nr kat.		Ø cm	cap ml	op.	PLN	EUR
R-RETINTB06-12	<i>Prima</i>	7	65	12	25,27	-



Miska Thali
Bowl Thali

Nr kat.		Ø cm	cap ml	op.	PLN	EUR
R-RETINTB07-12	<i>Prima</i>	8	100	12	34,33	-
R-RETINTB12-12	<i>Prima</i>	12,5	275	12	56,92	-

EARTH BAANTNA ARGILA



Taca Thali
Tray Thali

Nr kat.		Ø cm	h cm	op.	PLN	EUR
R-REAINTP31-2	<i>Epura</i>	33,5	3,5	2	324,56	-



Mieczka Thali
Bowl Thali

Nr kat.		Ø cm	cap ml	op.	PLN	EUR
R-REAINTB06-12	<i>Epura</i>	7	65	12	25,27	-



Miska Thali
Bowl Thali

Nr kat.		Ø cm	cap ml	op.	PLN	EUR
R-REAINTB07-12	<i>Epura</i>	8	100	12	34,33	-
R-REAINTB12-12	<i>Epura</i>	12,5	275	12	56,92	-





N

Talerz płaski
Flat plate

Nr kat.		Ø cm	op.	PLN	EUR
R-REALUFP16-24	<i>Epura</i>	15,5	24	47,44	-
R-REALUFP19-24	<i>Epura</i>	18,5	24	53,91	-
R-REALUFP21-12	<i>Epura</i>	20,5	12	64,26	-
R-REALUFP24-12	<i>Epura</i>	23,5	12	83,58	-
R-REALUFP27-12	<i>Epura</i>	26,5	12	106,78	-
R-REALUFP29-12	<i>Epura</i>	29	12	139,47	-



N

Talerz płaski
Flat plate

Nr kat.		Ø cm	op.	PLN	EUR
R-REALUFP16E11-24	<i>Larissa</i>	15,5	24	66,58	-
R-REALUFP19E11-24	<i>Larissa</i>	18,5	24	75,47	-
R-REALUFP21E11-12	<i>Larissa</i>	20,5	12	90,05	-
R-REALUFP24E11-12	<i>Larissa</i>	23,5	12	116,87	-
R-REALUFP27E11-12	<i>Larissa</i>	26,5	12	149,64	-
R-REALUFP29E11-12	<i>Larissa</i>	29	12	195,36	-



N

Talerz głęboki
Deep plate

Nr kat.		Ø cm	cap ml	op.	PLN	EUR
R-REANND26-12	<i>Epura</i>	26	1085	12	144,90	-
R-REANND30-6	<i>Epura</i>	29,5	1800	6	195,79	-
R-REANND36-3	<i>Epura</i>	36	2500	3	290,23	-



N

Talerz głęboki
Deep plate

Nr kat.		Ø cm	cap ml	op.	PLN	EUR
R-REANND26E11-12	<i>Larissa</i>	26	1085	12	202,77	-
R-REANND30E11-6	<i>Larissa</i>	29,5	1800	6	274,27	-
R-REANND36E11-3	<i>Larissa</i>	36	2500	3	406,50	-



Półmisek
Dish

Nr kat.		l cm	w cm	op.	PLN	EUR
R-REANNOP32-6	<i>Epura</i>	32	23	6	139,47	-



Półmisek
Dish

Nr kat.		l cm	w cm	op.	PLN	EUR
R-REANNOP32E11-6	<i>Larissa</i>	32	23	6	195,36	-



Miska
Bowl

Nr kat.		Ø cm	cap ml	op.	PLN	EUR
R-REANNBW12-12	<i>Epura</i>	12	270	12	59,34	-
R-REANNRB16-12	<i>Epura</i>	16	580	12	72,62	-
R-REANNRB20-6	<i>Epura</i>	20	1300	6	122,13	-



Miska
Bowl

Nr kat.		Ø cm	cap ml	op.	PLN	EUR
R-REANNBW12E11-12	<i>Larissa</i>	12	270	12	83,06	-
R-REANNRB16E11-12	<i>Larissa</i>	16	580	12	101,78	-
R-REANNRB20E11-6	<i>Larissa</i>	20	1300	6	171,03	-



Filizanka do espresso
Espresso cup

Nr kat.		Ø cm	h cm	cap ml	op.	PLN	EUR
R-REA116CU08-12	<i>Epura</i>	6,5	5,5	80	12	47,01	-

Spodek do filiżanki do espresso
Saucer for espresso cup

Nr kat.		Ø cm	op.	PLN	EUR
R-REACLA13-12	<i>Epura</i>	12,5	12	39,07	-



Filizanka do espresso
Espresso cup

Nr kat.		Ø cm	h cm	cap ml	op.	PLN	EUR
R-REA116CU08E11-12	<i>Larissa</i>	6,5	5,5	80	12	65,81	-

Spodek do filiżanki do espresso
Saucer for espresso cup

Nr kat.		Ø cm	op.	PLN	EUR
R-REACLA13E11-12	<i>Larissa</i>	12,5	12	54,68	-



 Filizanka
Cup

Nr kat.		Ø cm	h cm	cap ml	op.	PLN	EUR
R-REA116CU23-12	<i>Epura</i>	9	6	230	12	72,62	-
R-REA116CU28-12	<i>Epura</i>	10,5	6,5	280	12	79,09	-

 Spodek do filizanki
Saucer for cup

Nr kat.		Ø cm	op.	PLN	EUR
R-REACLSA02-12	<i>Epura</i>	17	12	57,27	-

 Filizanka
Cup

Nr kat.		Ø cm	h cm	cap ml	op.	PLN	EUR
R-REA116CU23E11-12	<i>Larissa</i>	9	6	230	12	101,78	-
R-REA116CU28E11-12	<i>Larissa</i>	10,5	6,5	280	12	110,83	-

 Spodek do filizanki
Saucer for cup

Nr kat.		Ø cm	op.	PLN	EUR
R-REACLSA02E11-12	<i>Larissa</i>	17	12	80,38	-

 Kubek
Mug

Nr kat.		Ø cm	h cm	cap ml	op.	PLN	EUR
R-REAEAMG30H-12	<i>Epura</i>	8	10	300	12	72,62	-

 Spodek do kubka
Saucer for mug

Nr kat.		Ø cm	op.	PLN	EUR
R-REACLSA02-12	<i>Epura</i>	17	12	57,27	-

 Kubek
Mug

Nr kat.		Ø cm	h cm	cap ml	op.	PLN	EUR
R-REAEAMG30HE11-12	<i>Larissa</i>	8	10	300	12	101,78	-

 Spodek do kubka
Saucer for mug

Nr kat.		Ø cm	op.	PLN	EUR
R-REACLSA02E11-12	<i>Larissa</i>	17	12	80,38	-



Talerz głęboki
Deep plate

Nr kat.	Ø cm	h cm	cap ml	op.	PLN	EUR
R-REGCLXD23-6	22,5	8	330	6	142,92	-
R-REGCLXD26-6	26	9	500	6	178,02	-



Miska
Bowl

Nr kat.	Ø cm	h cm	cap ml	op.	PLN	EUR
R-REGEABW12-12	12	6	415	12	86,08	-
R-REGEABW16-4	16	5,5	750	4	106,52	-
R-REGEABW20-4	20	6	1200	4	145,68	-



Miska wysoka
High bowl

Nr kat.	Ø cm	h cm	cap ml	op.	PLN	EUR
R-REGEAHB10-12	10	8	400	12	91,68	-



Ramekin
Ramekin

Nr kat.	Ø cm	cap ml	op.	PLN	EUR
R-REGEABR06-12	6,5	45	12	47,44	-
R-REGEABR08-12	8	100	12	57,10	-
R-REGEABR10-12	10	200	12	69,00	-





DOŻYWOTNIA
GWARANCJA
NA WYSZCZERBIENIA

RAK STONE to nowa receptura, łącząca zalety porcelany i kamionki w jednym produkcie. To porcelana niezwykle wytrzymała, twarda, odporna na zarysowania. Podstawową różnicą w stosunku do klasycznej porcelany jest skład surowca, jego barwa (kolor szary lub brązowy ze względu na składniki gliny użytej do produkcji) i nieprzepuszczalność światła.

***RAK STONE** is a new recipe, combining the advantages of porcelain and stoneware in one product. It's extremely durable, hard and scratch-resistant. The main difference from classic porcelain is the composition of the raw material, its color (gray or brown color due to the components of the clay used in production) and impermeability to light.*

rakstone

KERRAZZO



Talerz płaski
Flat plate

Nr kat.	Ø cm	h cm	op.	PLN	EUR
R-KELUFP16-24	15,7	1,6	24	26,10	-
R-KELUFP21-12	20,5	1,5	12	35,55	-
R-KELUFP24-12	23,6	1,5	12	46,17	-
R-KELUFP27-12	26,5	2	12	59,22	-
R-KELUFP31-6	30,8	1,9	6	81,90	-



Talerz głęboki
Deep plate

Nr kat.	Ø cm	h cm	cap ml	op.	PLN	EUR
R-KELUDP27-12	26,9	3,6	1050	12	65,70	-





rakstone

- ręczne wykończenie tworzy niepowtarzalne efekty, które dodają całości rustykalnego uroku
- idealna glazura zapobiega absorpcji tłuszczu, zapachu i bakterii
- naczynia mogą być myte w zmywarkach i stosowane w piecach konwekcyjno-parowych oraz kuchenkach mikrofalowych (temp. do 200°C). Można przechowywać w lodówce i zamrażarce w temperaturze do -20°C
- *the hand-made finish creates unique effects that add a rustic charm to the whole*
- *perfect glaze prevents fat absorption, odor and bacteria*
- *the dishes can be washed in dishwashers and used in combi steamers and microwave ovens (temperature up to 200 °C). Can be stored in the refrigerator and freezer at temperatures down to -20°C*

Ze względu na ręczne zdobienia naczynia mogą się nieco różnić kolorystycznie między sobą.
Due to hand-decorated finish dishes may vary in tone or detail.



Talerz głęboki
Deep plate

Nr kat.	Ø cm	h cm	cap ml	op.	PLN	EUR
○ R-EADC24-2	23,7	4,6	1300	2	42,63	-
● R-EADC24CA-2	23,7	4,6	1300	2	85,27	-
● R-EADC24CO-2	23,7	4,6	1300	2	85,27	-
● R-EADC24HO-2	23,7	4,6	1300	2	85,27	-
● R-EADC24CL-2	23,7	4,6	1300	2	81,54	-
○ R-EADC30-2	29,7	4,7	2300	2	70,22	-
● R-EADC30CA-2	29,7	4,7	2300	2	139,17	-
● R-EADC30CO-2	29,7	4,7	2300	2	139,17	-
● R-EADC30HO-2	29,7	4,7	2300	2	139,17	-
● R-EADC30CL-3	29,7	4,7	2300	3	133,74	-



Miska
Bowl





Nr kat.	Ø cm	h cm	cap ml	op.	PLN	EUR
○ R-EABW20-4	20	5,8	1200	4	33,85	-
● R-EABW20CA-4	20	5,8	1200	4	66,45	-
● R-EABW20CO-4	20	5,8	1200	4	66,45	-
● R-EABW20HO-4	20	5,8	1200	4	66,45	-
● R-EABW20CL-4	20	5,8	1200	4	63,63	-









Ze względu na ręczne zdobienia naczynia mogą się nieco różnić kolorystycznie między sobą. | Due to hand-decorated finish dishes may vary in tone or detail.

Talerz płaski Flat coupe plate

Nr kat.	Ø cm	op.	PLN	EUR	
biały					
R-EACP16-24	16,2	24	25,07	-	
R-EACP24-12	23,8	12	36,37	-	
R-EACP28-12	27,5	12	52,66	-	
R-EACP32-6	31,7	6	77,74	-	
wulkaniczny					
R-EACP16CA-24	16,2	24	50,16	-	
R-EACP24CA-12	23,8	12	72,72	-	
R-EACP28CA-12	27,5	12	105,33	-	
R-EACP32CA-6	31,7	6	156,73	-	
kobaltowy					
R-EACP16CO-24	16,2	24	50,16	-	
R-EACP24CO-12	23,8	12	72,72	-	
R-EACP28CO-12	27,5	12	105,33	-	
R-EACP32CO-6	31,7	6	156,73	-	
bursztynowy					
R-EACP16HO-24	16,2	24	50,16	-	
R-EACP24HO-12	23,8	12	72,72	-	
R-EACP28HO-12	27,5	12	105,33	-	
R-EACP32HO-6	31,7	6	156,73	-	
silgranitowy					
R-EACP16CL-24	16,2	24	48,42	-	
R-EACP24CL-12	23,8	12	69,12	-	
R-EACP28CL-12	27,5	12	101,43	-	
R-EACP32CL-6	31,7	6	149,85	-	

Talerz płaski Flat plate

Nr kat.	Ø cm	op.	PLN	EUR	
biały					
R-EAFP24-12	23,7	12	33,85	-	
R-EAFP28-12	27,6	12	50,16	-	
R-EAFP32-6	31,8	6	75,23	-	
wulkaniczny					
R-EAFP24CA-12	23,7	12	68,96	-	
R-EAFP28CA-12	27,6	12	99,05	-	
R-EAFP32CA-6	31,8	6	151,72	-	
kobaltowy					
R-EAFP24CO-12	23,7	12	68,96	-	
R-EAFP28CO-12	27,6	12	99,05	-	
R-EAFP32CO-6	31,8	6	151,72	-	
bursztynowy					
R-EAFP24HO-12	23,7	12	68,96	-	
R-EAFP28HO-12	27,6	12	99,05	-	
R-EAFP32HO-6	31,8	6	151,72	-	
silgranitowy					
R-EAFP24CL-12	23,7	12	65,97	-	
R-EAFP28CL-12	27,6	12	94,59	-	
R-EAFP32CL-6	31,8	6	145,26	-	



 Półmisek
Oval plate

Nr kat.	l cm	h cm	w cm	op.	PLN	EUR
○ R-EAOP23-12	23	3,1	15	12	38,87	-
● R-EAOP23CA-12	23	3,1	15	12	77,74	-
● R-EAOP23CO-12	23	3,1	15	12	77,74	-
● R-EAOP23HO-12	23	3,1	15	12	77,74	-
● R-EAOP23CL-12	23	3,1	15	12	74,25	-

 Miska
Bowl

Nr kat.	Ø cm	h cm	cap ml	op.	PLN	EUR
○ R-EABR08-12	8	4	100	12	16,30	-
● R-EABR08CA-12	8	4	100	12	31,34	-
● R-EABR08CO-12	8	4	100	12	31,34	-
● R-EABR08HO-12	8	4	100	12	31,34	-
● R-EABR08CL-12	8	4	100	12	29,97	-

 Filiżanka
Cup

Nr kat.	Ø cm	h cm	cap ml	op.	PLN	EUR
○ R-EACU23-12	7,3	9,2	230	12	26,33	-
● R-EACU23CA-12	7,3	9,2	230	12	52,66	-
● R-EACU23CO-12	7,3	9,2	230	12	52,66	-
● R-EACU23HO-12	7,3	9,2	230	12	52,66	-
● R-EACU23CL-12	7,3	9,2	230	12	50,76	-

 Spodek
Saucer

Nr kat.	→ □	Ø cm	op.	PLN	EUR
○ R-EASA16-12	do R-EACU23-12	16,3	12	20,06	-
● R-EASA16CA-12	do R-EACU23CA-12	16,3	12	38,87	-
● R-EASA16CO-12	do R-EACU23CO-12	16,3	12	38,87	-
● R-EASA16HO-12	do R-EACU23HO-12	16,3	12	38,87	-
● R-EASA16CL-12	do R-EACU23CL-12	16,3	12	36,90	-

 Kubek
Cup

Nr kat.	Ø cm	h cm	cap ml	op.	PLN	EUR
○ R-EACU23M-12	7,3	9,2	230	12	22,77	-
● R-EACU23MCA-12	7,3	9,2	230	12	45,54	-
● R-EACU23MCO-12	7,3	9,2	230	12	45,54	-
● R-EACU23MHO-12	7,3	9,2	230	12	45,54	-
● R-EACU23MCL-12	7,3	9,2	230	12	45,54	-





Ze względu na ręczne zdobienia naczynia mogą się nieco różnić kolorystycznie między sobą. | Due to hand-decorated finish dishes may vary in tone or detail.



Filizanka do espresso
Espresso cup

Nr kat.	Ø cm	h cm	cap ml	op.	PLN	EUR
○ R-EACU09-12	5,8	6,9	90	12	20,06	-
● R-EACU09CA-12	5,8	6,9	90	12	41,38	-
● R-EACU09CO-12	5,8	6,9	90	12	41,38	-
● R-EACU09HO-12	5,8	6,9	90	12	41,38	-
● R-EACU09CL-12	5,8	6,9	90	12	39,15	-



Spodek do espresso
Espresso saucer

Nr kat.	→ □	Ø cm	op.	PLN	EUR
○ R-EASA13-12	R-EACU09-12	13	12	15,05	-
● R-EASA13CA-12	R-EACU09CA-12	13	12	30,10	-
● R-EASA13CO-12	R-EACU09CO-12	13	12	30,10	-
● R-EASA13HO-12	R-EACU09HO-12	13	12	30,10	-
● R-EASA13CL-12	R-EACU09CL-12	13	12	29,07	-



R-SPTBAPP33-6



R-SJDBAPP33-6



R-SSRBAPP33-6



R-SGRBAPP33-6

Talerz do pizzy
Pizza plate



Nr kat.	Ø cm	op.	PLN	EUR
R-SPTBAPP33-6	33	6	52,92	-
R-SJDBAPP33-6	33	6	52,92	-
R-SSRBAPP33-6	33	6	52,92	-
R-SGRBAPP33-6	33	6	52,92	-





Talerz płaski
Flat plate

Nr kat.	Ø cm	op.	PLN	EUR
● R-WDNNPR24BG-12	24	12	40,12	-
● R-WDNNPR24MG-12	24	12	40,12	-
● R-WDNNPR29BG-12	29	12	82,76	-
● R-WDNNPR29MG-12	29	12	82,76	-



Talerz głęboki
Deep plate

Nr kat.	Ø cm	cap ml	op.	PLN	EUR
● R-WDBUBC26BG-12	26	1200	12	111,60	-
● R-WDBUBC26MG-12	26	1200	12	111,60	-





Talerz płaski
Flat plate

Nr kat.	Ø cm	col	op.	PLN	EUR
R-CRERP30-6	30	○	6	80,24	-
N R-KRCRERP30-6	30	●	6	149,00	-



Kubek
Cup

Nr kat.	Ø cm	h cm	cap ml	op.	PLN	EUR
R-STCU09M-12	6	5,5	90	12	21,32	-
R-STCU18M-12	7,5	7	190	12	37,61	-

Spodek
Saucer

Nr kat.	Ø cm	op.	PLN	EUR
R-STSA14-12	14	12	38,87	-

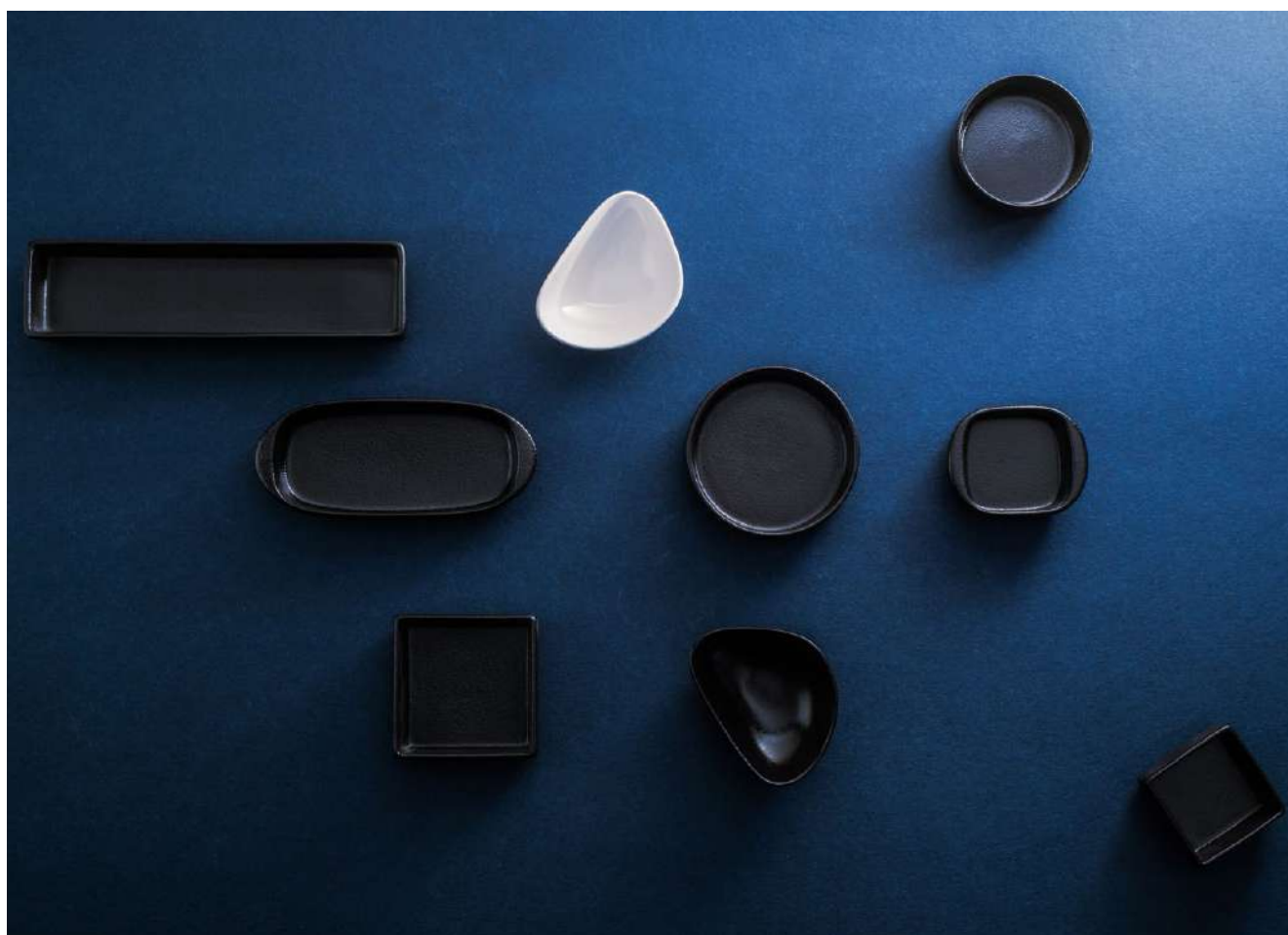

Talerz głęboki
Deep plate

Nr kat.	Ø cm	h cm	cap ml	op.	PLN	EUR
● R-KRCHDP29-6	29,5	5,5	500	6	120,37	-
○ R-CHDP29-6	29,5	5,5	500	6	80,24	-



Naczynko
Dish

Nr kat.	l cm	h cm	w cm	cap ml	op.	PLN	EUR
R-NFSTREP17-12	17	2,5	7	110	12	36,37	-



Naczynko
Dish

Nr kat.	l cm	h cm	w cm	cap ml	op.	PLN	EUR
R-NFSTSED09-12	6,5	2,5	6,5	52	12	20,06	-



Naczynko
Dish

Nr kat.	l cm	h cm	w cm	cap ml	op.	PLN	EUR
R-NFSTSQDD09-12	9	6	9	330	12	33,85	-





Talerz płaski
Flat plate

Nr kat.	l cm	w cm	op.	PLN	EUR
R-KRSHFP27-12	27	21,5	12	50,66	-
R-KRSHFP33-6	33	25	6	71,10	-



Talerz głęboki
Deep plate

Nr kat.	l cm	h cm	w cm	cap ml	op.	PLN	EUR
R-KRSHSB25-12	25	4,5	21	750	12	64,82	-
R-KRSHSB28-12	28	5	23,5	1070	12	88,02	-



Talerz głęboki
Deep plate

Nr kat.	l cm	h cm	w cm	cap ml	op.	PLN	EUR
R-KRSHSB19-12	19	4,5	15	350	12	35,11	-



Miseczka
Bowl

Nr kat.	l cm	h cm	w cm	cap ml	op.	PLN	EUR
R-KRSHSB11-12	10	4	9	80	12	26,96	-



Talerz płaski
Flat plate

Nr kat.	l cm	h cm	w cm	op.	PLN	EUR
R-SHFP27-12	27	1,6	21,5	12	90,28	-
R-SHFP33-6	33	1,7	25	6	122,88	-



Talerz głęboki
Deep plate

Nr kat.	l cm	h cm	w cm	cap ml	op.	PLN	EUR
R-SHSB25-12	25	4,5	21	750	12	90,28	-
R-SHSB28-12	28	5	23,5	1070	12	96,55	-



Talerz głęboki
Deep plate

Nr kat.	l cm	h cm	w cm	cap ml	op.	PLN	EUR
R-SHSB19-12	19	4,5	15	350	12	50,16	-



Miseczka
Bowl

Nr kat.	l cm	h cm	w cm	cap ml	op.	PLN	EUR
R-SHSB11-12	10	4	9	80	12	18,05	-



SUGGESTIONS



Półmisek
Dish

Nr kat.	l cm	h cm	w cm	op.	PLN	EUR
R-NFSHREP18-12	17,6	1,5	16,2	12	75,23	-
R-NFSHREP26-12	26,5	1,5	16,2	12	105,33	-



Półmisek
Dish

Nr kat.	l cm	h cm	w cm	op.	PLN	EUR
R-NFSHREP32-6	32,5	1,5	17,6	6	135,42	-
R-NFSHREP32W-6	32,5	1,5	26,5	6	173,04	-



Półmisek
Dish

Nr kat.	l cm	h cm	w cm	op.	PLN	EUR
R-SHSRP35-2	35	6	25	2	140,43	-



Półmisek
Dish

Nr kat.	l cm	h cm	w cm	op.	PLN	EUR
R-SHSRP32-2	32	6	15	2	90,28	-



Półmisek
Dish

Nr kat.	l cm	h cm	w cm	op.	PLN	EUR
R-SHSRP25-2	25	5,5	20	2	70,22	-

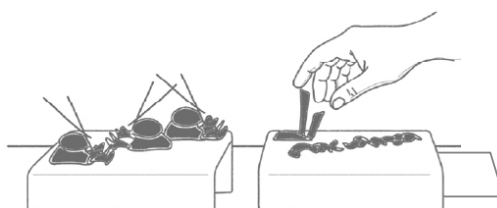

SUGGESTIONS



Talerz płaski
Flat plate

Nr kat.	Ø cm	h cm	op.	PLN	EUR
R-APRFP30-6	30	1,5	6	65,20	-



Dzbanek
Jug

Nr kat.	h cm	cap ml	op.	PLN	EUR
R-SWJG9-12	10,5	90	12	32,60	-
R-SWJG20-12	12,5	200	12	50,16	-
R-SWJG60-6	18,5	600	6	76,49	-

HIDE



Talerz płaski gourmet
Gourmet flat plate

Nr kat.	Ø cm	op.	PLN	EUR
R-HDMP32-6	32	6	122,88	-



Pokrywa
Cover

Nr kat.	Ø cm	h cm	op.	PLN	EUR
R-UHDCL18G-2	18	20,5	2	200,61	-



Pokrywa
Cover

Nr kat.	Ø cm	h cm	op.	PLN	EUR
R-HDCL18-2	18	20,5	2	122,88	-

KUP ON-LINE



SENSATION

 Naczynie Koshou
Koshou dish

Nr kat.	l cm	h cm	w cm	op.	PLN	EUR
R-SNKS23-6	23	3	6	6	45,14	-

 Naczynie Goma
Goma dish

Nr kat.	l cm	h cm	w cm	cap ml	op.	PLN	EUR
R-SNGM09-12	8,5	3	8,5	130	12	23,83	-

 Naczynie Asa
Asa dish

Nr kat.	l cm	h cm	w cm	cap ml	op.	PLN	EUR
R-SNAS07-12	6,5	3	6,5	70	12	16,30	-

 Naczynie Sakura
Sakura dish

Nr kat.	Ø cm	h cm	cap ml	op.	PLN	EUR
R-SNSK15-12	14,5	3	330	12	38,87	-

 Naczynie Orenji
Orenji dish

Nr kat.	Ø cm	h cm	cap ml	op.	PLN	EUR
R-SNOR11-12	10,6	3	160	12	25,07	-

 Naczynie Yuzu
Yuzu dish

Nr kat.	Ø cm	h cm	cap ml	op.	PLN	EUR
R-SNYZ09-12	8,5	3	100	12	17,55	-



AUREA

 Talerz płaski / półmisek
Flat plate / dish

Nr kat.	l cm	w cm	op.	PLN	EUR
R-AURP38-6	38	21	6	99,05	-

 Talerz płaski
Flat plate

Nr kat.	l cm	w cm	op.	PLN	EUR
R-AUSP15-24	15	15	24	20,04	-
R-AUSP24-12	24	24	12	71,46	-
R-AUSP27-6	27	27	6	82,76	-



Talerz płaski
Flat plate

Nr kat.	Ø cm	op.	PLN	EUR
R-MFEVFP33GB-6	33	6	190,59	-



Talerz głęboki
Deep plate

Nr kat.	Ø cm	h cm	cap ml	op.	PLN	EUR
R-MFFDGD26GB-6	26	5,9	1200	6	139,17	-
R-MFFDGD29GB-6	29	5,9	1700	6	164,26	-



Miska
Bowl

Nr kat.	Ø cm	h cm	cap ml	op.	PLN	EUR
R-MFFDBI12GB-12	12	6	280	12	50,16	-





Talerz płaski
Flat plate

Nr kat.	Ø cm	op.	PLN	EUR
R-KRNNPR15-24	15	24	23,83	-
R-KRNNPR21-12	21	12	28,84	-
R-KRNNPR24-12	24	12	31,34	-
R-KRNNPR27-12	27	12	46,39	-
R-KRNNPR29-12	29	12	65,20	-
R-KRNNPR31-6	31	6	75,23	-



Talerz głęboki
Deep plate

Nr kat.	Ø cm	cap ml	op.	PLN	EUR
R-KRNNDP23-12	23	700	12	36,37	-
R-KRBUBC26-12	26	1200	12	87,77	-
R-KRNNDP28-12	28	1380	12	97,80	-



Półmisek
Dish

Nr kat.	l cm	w cm	op.	PLN	EUR
R-KRNNOP32-6	32	23	6	80,24	-
R-KRNNOP36-6	36	27	6	91,54	-



Talerz płaski
Flat plate

Nr kat.	l cm	w cm	op.	PLN	EUR
R-KRAURPM22-12	22	11	12	43,89	-



KARBON



Talerz płaski
Flat plate

Nr kat.	l cm	w cm	op.	PLN	EUR
R-KRAURP38-6	38	21	6	120,37	-



Talerz płaski
Flat plate

Nr kat.	l cm	w cm	op.	PLN	EUR
R-KRAURPN33-12	33	11	12	67,71	-



Talerz płaski
Flat plate

Nr kat.	l cm	w cm	op.	PLN	EUR
R-KRAURX33-6	33	27	6	141,68	-



Talerz płaski
Flat plate

Nr kat.	l cm	w cm	op.	PLN	EUR
R-KRAURPW33W-6	33	22	6	139,17	-



Talerz płaski
Flat plate

Nr kat.	l cm	w cm	op.	PLN	EUR
R-KRAUSP15-24	15	15	24	25,07	-
R-KRAUSP22-12	22	22	12	81,50	-
R-KRAUSP24-12	24	24	12	86,51	-
R-KRAUSP27-6	27	27	6	100,31	-
R-KRAUSP30-6	30	30	6	141,68	-
R-KRAUSP33-6	33	33	6	196,85	-



Miseczka
Bowl

Nr kat.	Ø cm	cap ml	op.	PLN	EUR
R-KRNNBW10-12	10,5	160	12	24,60	-
R-KRNNBW12-12	12	270	12	36,37	-
R-KRNNRB16-12	16	580	12	42,63	-



Filizanka do espresso
Espresso cup

Nr kat.	Ø cm	h cm	cap ml	op.	PLN	EUR
R-KR116CU08-12	6,5	5,3	80	12	27,59	-



Spodek
Saucer

Nr kat.	Ø cm	op.	PLN	EUR
R-KRCLSA13-12	13	12	23,83	-



Filizanka
Cup

Nr kat.	Ø cm	h cm	cap ml	op.	PLN	EUR
R-KR116CU20-12	8,7	6	200	12	41,38	-
R-KR116CU23-12	9	6,1	230	12	46,39	-



Spodek
Saucer

Nr kat.	Ø cm	op.	PLN	EUR
R-KRCLSA02-12	17	12	35,11	-





Talerz płaski
Flat plate

Nr kat.	Ø cm	op.	PLN	EUR
R-SHNNPR15-24	15	24	23,83	-
R-SHNNPR21-12	21	12	28,84	-
R-SHNNPR24-12	24	12	31,34	-
R-SHNNPR27-12	27	12	46,39	-
R-SHNNPR29-12	29	12	65,20	-
R-SHNNPR31-6	31	6	75,23	-



Talerz płaski
Flat plate

Nr kat.	l cm	w cm	op.	PLN	EUR
R-SHNNOP32-6	32	23	6	80,24	-
R-SHNNOP36-6	36	27	6	91,54	-



Talerz głęboki
Deep plate

Nr kat.	Ø cm	cap ml	op.	PLN	EUR
R-SHNDP23-12	23	700	12	36,37	-
R-SHBUBC26-12	26	1200	12	87,77	-
R-SHNDP28-12	28	1380	12	97,80	-



Talerz płaski
Flat plate

Nr kat.	l cm	w cm	op.	PLN	EUR
R-SHAURX33-6	33	27	6	141,68	-



Talerz płaski
Flat plate

Nr kat.	l cm	w cm	op.	PLN	EUR
R-SHAUSP27-6	27	27	6	100,31	-
R-SHAUSP33-6	33	33	6	196,85	-



Talerz płaski
Flat plate

Nr kat.	l cm	w cm	op.	PLN	EUR
R-SHAURP38-6	38	21	6	120,37	-



Talerz płaski
Flat plate

Nr kat.	l cm	w cm	op.	PLN	EUR
R-SHAURPW33-6	33	20	6	139,17	-

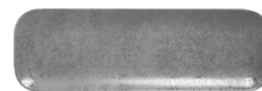

Talerz płaski
Flat plate

Nr kat.	l cm	w cm	op.	PLN	EUR
R-SHAURPN33-12	33	11	12	67,71	-

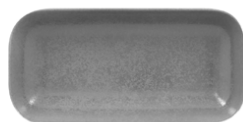

Talerz płaski
Flat plate

Nr kat.	l cm	w cm	op.	PLN	EUR
R-SHAURPM22-12	22	11	12	43,89	-



Miseczka
Bowl

Nr kat.	Ø cm	h cm	cap ml	op.	PLN	EUR
R-SHNNBW12-12	12	5,5	270	12	36,37	-
R-SHNNRB16-12	16	6,5	580	12	42,63	-



Filizanka do espresso
Espresso cup

Nr kat.	Ø cm	h cm	cap ml	op.	PLN	EUR
R-SH116CU08-12	6,5	5,3	80	12	27,59	-



Spodek do filiżanki do espresso
Espresso cup saucer

Nr kat.	Ø cm	op.	PLN	EUR
R-SHCLSA13-12	13	12	23,83	-



Filizanka
Cup

Nr kat.	Ø cm	h cm	cap ml	op.	PLN	EUR
R-SH116CU20-12	8,7	6,3	200	12	41,38	-
R-SH116CU23-12	9	6,1	230	12	46,39	-



Spodek do filiżanki
Saucer

Nr kat.	Ø cm	op.	PLN	EUR
R-SHCLSA02-12	17	12	35,11	-





Talerz płaski
Flat plate

Nr kat.	Ø cm	h cm	op.	PLN	EUR
● R-FRNOLD23GR-6	23	2,5	6	85,27	-
● R-FRNOLD23OR-6	23	2,5	6	85,27	-
● R-FRNOLD23RD-6	23	2,5	6	85,27	-
● R-FRNOLD27GR-6	27	2,6	6	95,29	-
● R-FRNOLD27OR-6	27	2,6	6	95,29	-
● R-FRNOLD27RD-6	27	2,6	6	95,29	-



Talerz płaski
Flat plate

Nr kat.	Ø cm	op.	PLN	EUR
● R-FRNNPR24GR-12	24	12	45,14	-
● R-FRNNPR24OR-12	24	12	45,14	-
● R-FRNNPR24RD-12	24	12	45,14	-
● R-FRNNPR27GR-12	27	12	67,71	-
● R-FRNNPR27OR-12	27	12	67,71	-
● R-FRNNPR27RD-12	27	12	67,71	-





Talerz głęboki
Deep plate

Nr kat.	Ø cm	h cm	cap ml	op.	PLN	EUR
● R-FRCLXD26GR-6	26	8,8	500	6	126,64	-
● R-FRCLXD26OR-6	26	8,8	500	6	126,64	-
● R-FRCLXD26RD-6	26	8,8	500	6	126,64	-



Talerz głęboki
Deep plate

Nr kat.	Ø cm	h cm	cap ml	op.	PLN	EUR
● R-FRNNDP28GR-12	28	4,7	1380	12	80,24	-
● R-FRNNDP28OR-12	28	4,7	1380	12	80,24	-
● R-FRNNDP28RD-12	28	4,7	1380	12	80,24	-



Talerz głęboki
Deep plate

Nr kat.	Ø cm	h cm	cap ml	op.	PLN	EUR
● R-FRNODP23GR-6	23	4,2	975	6	94,04	-
● R-FRNODP23OR-6	23	4,2	975	6	94,04	-
● R-FRNODP23RD-6	23	4,2	975	6	94,04	-
● R-FRNODP27GR-6	27	4	1400	6	100,31	-
● R-FRNODP27OR-6	27	4	1400	6	100,31	-
● R-FRNODP27RD-6	27	4	1400	6	100,31	-



Miska
Bowl

Nr kat.	Ø cm	h cm	cap ml	op.	PLN	EUR
● R-FRNOBW14GR-12	14	6	620	12	57,67	-
● R-FRNOBW14OR-12	14	6	620	12	57,67	-
● R-FRNOBW14RD-12	14	6	620	12	57,67	-





Talerz płaski gourmet
Flat plate gourmet

Nr kat.	Ø cm	op.	PLN	EUR
R-NFMRFP30BK-12	30	12	91,54	-



Talerz głęboki
Deep plate

Nr kat.	Ø cm	cap ml	op.	PLN	EUR
● R-NFGDDP29BK-6	29	400	6	117,87	-
● R-NFGDDP29GY-6	29	400	6	117,87	-



Talerz głęboki
Deep plate

Nr kat.	Ø cm	cap ml	op.	PLN	EUR
R-NFCLXD23BK-6	23	330	6	58,93	-
R-NFCLXD26BK-6	26	500	6	68,96	-



Talerz głęboki
Deep plate

Nr kat.	Ø cm	cap ml	op.	PLN	EUR
● R-NFCLXD23GY-6	23	330	6	58,93	-
○ R-NFCLXD23WH-6	23	330	6	58,93	-
● R-NFCLXD26GY-6	26	500	6	68,96	-
○ R-NFCLXD26WH-6	26	500	6	68,96	-





Talerz płaski
Flat plate

Nr kat.	Ø cm	op.	PLN	EUR
---------	------	-----	-----	-----

Volcano - czarny

R-NFNNPR15BK-24	15	24	18,81	-
R-NFNNPR27BK-12	27	12	36,37	-
R-NFNNPR31BK-6	31	6	58,93	-



Stone - szary

R-NFNNPR15GY-24	15	24	18,81	-
R-NFNNPR27GY-12	27	12	36,37	-
R-NFNNPR31GY-6	31	6	58,93	-



Sand - biały

R-NFNNPR15WH-24	15	24	18,81	-
R-NFNNPR27WH-12	27	12	36,37	-
R-NFNNPR31WH-6	31	6	58,93	-



Mellow - brązowy

R-NFNNPR15CB-24	15	24	18,81	-
R-NFNNPR27CB-12	27	12	36,37	-
R-NFNNPR31CB-6	31	6	58,93	-



Miseczka
Bowl

Nr kat.	Ø cm	cap ml	op.	PLN	EUR
---------	------	--------	-----	-----	-----

Ember - czerwony

R-NFNRRB16BR-12	16	580	12	32,60	-
-----------------	----	-----	----	-------	---



Stone - szary

R-NFNRRB16GY-12	16	580	12	32,60	-
-----------------	----	-----	----	-------	---



Sand - biały

R-NFNRRB16WH-12	16	580	12	32,60	-
-----------------	----	-----	----	-------	---



Talerz głęboki
Deep plate

Nr kat.	Ø cm	cap ml	op.	PLN	EUR
---------	------	--------	-----	-----	-----

Volcano - czarny

R-NFBUBC30BK-6	30	1900	6	91,54	-
----------------	----	------	---	-------	---



Stone - szary

R-NFBUBC30GY-6	30	1900	6	91,54	-
----------------	----	------	---	-------	---



Sand - biały

R-NFBUBC30WH-6	30	1900	6	91,54	-
----------------	----	------	---	-------	---



Ramekin
Ramekin

Nr kat.	Ø cm	cap ml	op.	PLN	EUR
---------	------	--------	-----	-----	-----

Volcano - czarny

R-NFBABR02BK-12	8	100	12	20,06	-
-----------------	---	-----	----	-------	---



Ember - czerwony

R-NFBABR02BR-12	8	100	12	20,06	-
-----------------	---	-----	----	-------	---



Stone - szary

R-NFBABR02GY-12	8	100	12	20,06	-
-----------------	---	-----	----	-------	---



Sand - biały

R-NFBABR02WH-12	8	100	12	20,06	-
-----------------	---	-----	----	-------	---



Bytfanna
Over-pan

Nr kat.	l cm	h cm	w cm	cap ml	op.	PLN	EUR
● R-CFOD31BKBD-3	25,5	5,5	17,5	1200	3	106,57	-
● R-CFOD31BKLD-3 <i>pokrywka</i>	26	3	17,5	3	3	26,33	-
● R-CFOD37BKBD-3	30	6	21	2040	3	136,67	-
● R-CFOD37BKLD-3 <i>pokrywka</i>	31	3	21	3	3	33,85	-

Bytfanna
Over-pan

Nr kat.	l cm	h cm	w cm	cap ml	op.	PLN	EUR
● R-CFRT20BKBD-3	19,2	6	10	670	3	65,20	-
● R-CFRT32BKBD-3	31,5	6	22	2830	3	201,87	-
○ R-CFRT32WHBD-3	31,5	6	22	2830	3	201,87	-

Półmisek
Dish

Nr kat.	l cm	h cm	w cm	cap ml	op.	PLN	EUR
● R-NFOPD20BK-12	20	3,5	11	200	12	62,70	-
● R-NFOPD20GY-12	20	3,5	11	200	12	62,70	-
● R-NFOPD25BK-24	25	4,5	14	420	24	87,77	-
● R-NFOPD25GY-24	25	4,5	14	420	24	87,77	-
● R-NFOPD30BK-6	30	5	16	780	6	117,87	-
● R-NFOPD30GY-6	30	5	16	780	6	117,87	-

Kociołek
Cauldron

Nr kat.	Ø cm	h cm	cap ml	op.	PLN	EUR
● R-CFRD09BKBD-12	8,5	4,2	112	12	45,14	-
● R-CFRD10BKLD-12 <i>pokrywka</i>	10	1,8		12	12,54	-
● R-CFRD10GYBD-12	10	5,2	200	12	48,90	-
● R-CFRD10GYLD-12 <i>pokrywka</i>	10	1,8		12	12,54	-
● R-CFRD16BKBD-4	16	5,2	467	4	68,96	-
● R-CFRD16BKLD-6 <i>pokrywka</i>	16	2,8		6	17,55	-
● R-CFRD16GYBD-4	16	5,2	467	4	68,96	-
● R-CFRD16GYLD-6 <i>pokrywka</i>	16	2,8		6	17,55	-
● R-CFRD28BKBD-1	28	12	4600	1	369,89	-
● R-CFRD28BKLD-4 <i>pokrywka</i>	28	5		4	92,78	-
● R-CFRD28GYLD-4 <i>pokrywka</i>	28	5		4	92,78	-



Naczynie
Dish

Nr kat.	l cm	h cm	w cm	cap ml	op.	PLN	EUR
● R-NFOPRD16BK-12	21,5	4	18	450	12	73,98	-
● R-NFOPRD16GY-12	21,5	4	18	450	12	73,98	-



Talerz - patelnia
Plate - frying pan

Nr kat.	Ø cm	op.	PLN	EUR
R-CFPN12BK-12	12	12	56,43	-
R-CFPN16BK-6	16	6	91,54	-
R-CFPN24BK-6	24	6	111,60	-



Mini Waza
Mini vase

Nr kat.	Ø cm	h cm	cap ml	op.	PLN	EUR
● R-CFST10BK-2	10,6	10,5	450	2	97,80	-
● R-CFST10GY-2	10,6	10,5	450	2	97,80	-
● R-CFST15BK-2	15	14	1150	2	129,15	-

Pokrywka w zestawie
Cover included



Kubek
Mug

Nr kat.	h cm	cap ml	op.	PLN	EUR
● R-NFBAFM30BK-6	10,7	300	6	37,61	-
● R-NFBAFM30GY-6	10,7	300	6	37,61	-
● R-NFBAMG45BK-12	13	450	12	47,65	-
● R-NFBAMG45DR-12	13	450	12	47,65	-
● R-NFBAMG45GY-12	13	450	12	47,65	-





Talerz płaski
Flat plate

Nr kat.	Ø cm	op.	PLN	EUR
R-KZNNPR31G2-6	31	6	73,98	-



Filizanka
Espresso Cup

Nr kat.	h cm	cap ml	op.	PLN	EUR
R-KZSWCU10G2-12	6,5	100	12	40,12	-

Spodek
Saucer

Nr kat.	Ø cm	op.	PLN	EUR
R-KZWSA12G2-12	12	12	30,10	-



Filizanka
Cup

Nr kat.	h cm	cap ml	op.	PLN	EUR
R-KZSWCU23G2-12	8	230	12	53,92	-
R-KZSWCU30G2-12	9	300	12	61,44	-

Spodek
Saucer

Nr kat.	Ø cm	op.	PLN	EUR
R-KZWSA15G2-12	15	12	38,87	-



Talerz płaski
Flat plate

Nr kat.	Ø cm	op.	PLN	EUR
R-MEFP15-24	15	24	16,30	-
R-MEFP17-24	17	24	16,30	-
R-MEFP21-24	21	24	20,06	-
R-MEFP24-12	24	12	21,32	-
R-MEFP27-12	27	12	31,34	-
R-MEFP29-12	29	6	41,38	-
R-MEFP31-6	31	6	51,40	-



Talerz głęboki
Deep plate

Nr kat.	Ø cm	cap ml	op.	PLN	EUR
R-MEDP23-12	23	475	12	20,06	-
R-MEDP26-12	26	770	12	28,84	-
R-MEDP30-6	30	1280	6	45,14	-



Filizanka do espresso
Espresso cup

Nr kat.	Ø cm	cap ml	op.	PLN	EUR
R-MECU09-12	5,4	90	12	17,55	-

Spodek do filiżanki
Saucer

Nr kat.	Ø cm	op.	PLN	EUR
R-MESA13-12	13	12	16,30	-



Filizanka
Cup

Nr kat.	cap ml	op.	PLN	EUR
R-MECU20-12	200	12	26,33	-

Spodek do filiżanki
Saucer

Nr kat.	Ø cm	op.	PLN	EUR
R-MESA15-12	15	12	18,81	-



Filizanka
Cup

Nr kat.	cap ml	op.	PLN	EUR
R-MECU35-12	350	12	32,60	-

Spodek do filiżanki
Saucer

Nr kat.	Ø cm	op.	PLN	EUR
R-MESA17-12	17	12	22,57	-



Mlecznik
Milk jug

Nr kat.	cap ml	op.	PLN	EUR
R-MECR15-6	150	6	25,07	-





Talerz płaski
Flat plate

Nr kat.	Ø cm	op.	PLN	EUR
R-NOFP24-6	24	6	31,34	-
R-NOFP28-6	28	6	53,92	-
R-NOFP32-6	32	6	61,44	-



Talerz płaski
Flat plate

Nr kat.	Ø cm	op.	PLN	EUR
R-NOBD01-12	6	12	18,81	-



Talerz płaski, pokrywka
Flat plate / lid

Nr kat.	Ø cm	op.	PLN	EUR
R-NOLD12-12	12	12	22,57	-
R-NOLD14-12	14	12	23,83	-
R-NOLD16-12	16	12	27,59	-
R-NOLD20-12	20	12	37,61	-
R-NOLD23-6	23	6	40,12	-
R-NOLD27-6	27	6	43,89	-



Talerz płaski/ pokrywka
Flat plate / lid

Nr kat.	Ø cm	op.	PLN	EUR
R-NOLD16BKM-12	15,7	12	40,28	-
R-NOLD20BKM-12	19,8	12	56,78	-
R-NOLD23BKM-6	22,7	6	59,20	-
R-NOLD27BKM-6	26,7	6	66,11	-



Talerz głęboki
Deep plate

Nr kat.	Ø cm	cap ml	op.	PLN	EUR
R-NODP20-6	20	700	6	38,87	-
R-NODP23-6	23	900	6	43,89	-



Miska sztaplowalna
Bowl, stackable

Nr kat.	Ø cm	h cm	cap ml	op.	PLN	EUR
R-NOBW12-12	12	5	480	12	25,07	-
R-NOBW14-12	14	6	680	12	26,33	-
R-NOBW16-6	16	7	1000	6	28,84	-





Imbryk
Tea pot

Nr kat.	cap ml	op.	PLN	EUR
R-NOTP100	1000	4	64,92	-
R-NOTP40-4	400	4	58,93	-
R-NOTPLD1-12	<i>pokrywka zapasowa</i>	12	12,54	-
R-NOTPLD2-12	<i>pokrywka zapasowa</i>	12	16,30	-



Imbryk
Coffee pot

Nr kat.	cap ml	op.	PLN	EUR
R-NOCP100-4	1000	4	77,74	-
R-NOCP40-4	400	4	58,93	-
R-NOCPD1-12	<i>pokrywka zapasowa</i>	12	12,54	-
R-NOCPD2-12	<i>pokrywka zapasowa</i>	12	16,30	-



Bulionówka sztaplowalna
Creamsoup bowl, stackable

Nr kat.	Ø cm	cap ml	op.	PLN	EUR
R-NOCU30-6	9,6	300	6	27,59	-

Spodek do espresso / miseczka
Espresso saucer / bowl

Nr kat.	Ø cm	op.	PLN	EUR
R-NOSA3-6	15,5	6	12,54	-



Filizanka sztaplowalna
Cup, stackable

Nr kat.	Ø cm	cap ml	op.	PLN	EUR
R-NOCU09-12	6,3	90	12	17,55	-
R-NOCU23-12	9	230	12	26,33	-

Spodek do espresso / miseczka
Espresso saucer / bowl

Nr kat.		Ø cm	op.	PLN	EUR
R-NOSA1-12	<i>do NOCU09</i>	10	12	10,04	-
R-NOSA3-6	<i>do NOCU23</i>	15,5	6	12,54	-



Kubek sztaplowalny
Mug, stackable

Nr kat.	Ø cm	cap ml	op.	PLN	EUR
R-NOMG33-6	7,8	330	6	28,84	-



Mlecznik
Milk jug

Nr kat.	cap ml	op.	PLN	EUR
R-NOCR15-6	150	6	22,57	-
R-NOCR50-6	500	6	35,11	-



Pieprzniczka / Solniczka
Pepper shaker / Salt shaker

Nr kat.		op.	PLN	EUR
R-NOPS01-12	<i>pieprz</i>	12	16,30	-
R-NOSS01-12	<i>sól</i>	12	16,30	-



Filizanka do espresso, sztaplowalna
Espresso cup, stackable

Nr kat.	Ø cm	cap ml	op.	PLN	EUR
R-NOMB01-12	5,8	90	12	20,06	-

Talerz płaski
Flat plate

Nr kat.	Ø cm	op.	PLN	EUR
R-ANFP17-24	17	24	20,06	-
R-ANFP21-24	21	24	23,83	-
R-ANFP24-12	24	12	26,33	-
R-ANFP27-12	27	12	36,37	-
R-ANFP29-12	29	12	43,89	-
R-ANFP31-6	31	6	56,43	-

Talerz głęboki
Deep plate

Nr kat.	Ø cm	cap ml	op.	PLN	EUR
R-ANDP24-12	24	400	12	32,60	-
R-ANDP26-12	26	540	12	43,89	-
R-ANDP30-6	30	560	6	51,40	-





Półmisek
Dish

Nr kat.	l cm	w cm	op.	PLN	EUR
R-ANOP22-12	22	14	12	36,37	-
R-ANOP32-6	32	21	6	57,67	-
R-ANOP38-6	38	24,5	6	65,20	-



Miska
Bowl

Nr kat.	Ø cm	h cm	cap ml	op.	PLN	EUR
R-ANBW14-12	14	5,5	480	12	27,59	-
R-ANBW16-6	16	8	1000	6	35,11	-
R-ANBW18-6	18	9	1400	6	41,38	-
R-ANBW21-4	21	10,5	2300	4	55,17	-



Waza
Vase

Nr kat.	Ø cm	cap ml	op.	PLN	EUR
R-ANS23-1	23	2400	1	80,24	-
R-ANS26-1	26	3000	1	100,31	-



Bulionówka
Creamsoup bowl

Nr kat.	Ø cm	h cm	cap ml	op.	PLN	EUR
R-ANCS36-12	11	5,5	360	12	41,38	-

Spodek do bulionówki / sosjerki
Saucer for soup bowl / sauce boat

Nr kat.	Ø cm	op.	PLN	EUR
R-ANSA17-12	17	12	20,06	-





Dzbanek do kawy / herbaty
Coffee / Tea pot

Nr kat.	cap ml	op.	PLN	EUR
R-ANCP35-6	350	6	68,96	-



Filizanka do espresso
Espresso cup

Nr kat.	Ø cm	cap ml	op.	PLN	EUR
R-ANCU08-12	6	80	12	16,30	-

Spodek do filiżanki do espresso
Espresso cup saucer

Nr kat.	Ø cm	op.	PLN	EUR
R-ANSA13-12	13	12	13,79	-



Filizanka
Cup

Nr kat.	Ø cm	cap ml	op.	PLN	EUR
R-ANCU20-12	8	200	12	25,07	-
R-ANCU23-12	9	230	12	27,59	-

Spodek do filiżanki
Saucer

Nr kat.	Ø cm	op.	PLN	EUR
R-ANSA15-12	15	12	17,55	-



Kubek
Mug

Nr kat.	Ø cm	cap ml	op.	PLN	EUR
R-ANCU28-12	8	280	12	31,34	-
R-ANCU36-12	9	360	12	37,61	-

Spodek do filiżanki
Saucer

Nr kat.	Ø cm	op.	PLN	EUR
R-ANSA15-12	15	12	17,55	-



Dzbanek
Jug

Nr kat.	cap ml	op.	PLN	EUR
R-ANJU60-4	600	4	61,44	-
R-ANJU100-4	1000	4	81,50	-



Mlecznik
Milk jug

Nr kat.	cap ml	op.	PLN	EUR
R-ANCR15-12	150	12	27,34	-



Filizanka do espresso
Espresso cup

Nr kat.	h cm	cap ml	op.	PLN	EUR
R-116CU08-12	5,3	80	12	16,15	-



R-CLSA01-12



R-CLSA02-12

Spodek uniwersalny
Universal saucer

Nr kat.	Ø cm	op.	PLN	EUR
R-CLSA01-12	15,7	12	17,55	-
R-CLSA02-12	17	12	18,81	-



Filizanka
Cup

Nr kat.	h cm	cap ml	op.	PLN	EUR
R-116CU20-12	6	200	12	23,61	-
R-116CU23-12	6,1	230	12	23,61	-
R-116CU28-12	6,3	280	12	24,85	-
R-116CU37-12	6,7	370	12	27,34	-
R-116CU45-12	7,5	450	12	37,28	-



Spodek do filizanki
Saucer

Nr kat.	l cm	w cm	op.	PLN	EUR
R-SPRP24IN-6	24	14	6	85,27	-

Przykładowe pasujące elementy: | *Matching elements:*



R-BACS01-6

R-BACS02-12

R-BACS18-6

R-BACS30-6

R-BACU23-12

R-BANC22-12

R-BAGB35-4

R-BAFMG30-6

Przykładowe pasujące elementy: | *Matching elements:*



R-BANC22-12

R-BACS30-6

R-BACU23-12

R-FDCU30-12



Talerz płaski
Flat plate

Nr kat.	Ø cm	op.	PLN	EUR
R-BAFP13-24	13	24	13,79	-
R-BAFP15-24	15	24	15,05	-
R-BAFP17-24	17	24	16,30	-
R-BAFP19-24	19	24	16,30	-
R-BAFP20-24	20	24	18,81	-
R-BAFP21-24	21	24	18,81	-
R-BAFP23-12	23	12	20,06	-
R-BAFP24-12	24	12	20,06	-
R-BAFP25-12	25	12	25,07	-
R-BAFP27-12	27	12	30,10	-
R-BAFP29-12	29	12	37,61	-
R-BAFP30-6	30	6	40,12	-
R-BAFP31-6	31	6	47,65	-

Talerz płaski
Flat plate

Nr kat.	l cm	w cm	op.	PLN	EUR
R-BAOP30-6	30	25,5	6	41,38	-

Talerz głęboki
Deep plate

Nr kat.	Ø cm	cap ml	op.	PLN	EUR
R-BADP23-12	23	265	12	20,06	-
R-BADP26-12	26	770	12	28,84	-
R-BADP30-6	30	1280	6	41,38	-





Talerz płaski
Flat plate

Nr kat.	l cm	w cm	op.	PLN	EUR
R-AURPM22-12	22	11	12	43,89	-
R-AURPN33-12	33	11	12	67,71	-
R-AURPW33W-6	33	22	6	139,17	-



Talerz płaski
Flat plate

Nr kat.	l cm	w cm	op.	PLN	EUR
R-AUSP11-12	11	11	12	16,30	-
R-AUSP22-12	22	22	12	81,50	-



Półmisek
Dish

Nr kat.	l cm	w cm	op.	PLN	EUR
R-BAOP22-12	22	15	12	28,84	-
R-BAOP26-12	26	18	12	37,61	-
R-BAOP32-6	32	22	6	51,40	-
R-BAOP38-6	38	26	6	60,18	-
R-BAOP45-4	45	33	4	89,02	-



Talerz do pizzy
Pizza plate

Nr kat.	Ø cm	op.	PLN	EUR
R-BAPP33-6	33	6	36,37	-



Naczynie do zapiekania
Dish

Nr kat.	l cm	h cm	w cm	op.	PLN	EUR
R-BUOD25-6	25	5	18	6	80,24	-

Misa sztaplowalna
Stackable bowl

Nr kat.	Ø cm	cap ml	op.	PLN	EUR
R-BABW12-12	12	480	12	20,06	-
R-BABW14-12	14	630	12	27,59	-
R-BACS01-6	10	300	6	17,55	-



Miska sztaplowalna
Stackable bowl

Nr kat.	Ø cm	cap ml	op.	PLN	EUR
R-BASB12-12	12	250	12	18,81	-
R-BASB16-12	16	600	12	21,32	-
R-BASB18-12	18	720	12	36,37	-
R-BASB21-12	21	1180	12	47,65	-



Miska
Bowl

Nr kat.	Ø cm	cap ml	op.	PLN	EUR
R-BASP12-12	12	310	12	18,81	-
R-BASP14-12	14	500	12	20,06	-
V-BASP16-12	16	670	12	21,43	-
V-BASP20-12	20	1050	12	48,52	-
V-BASP25-1	25	2000	1	54,38	-
V-BASP31-1	31	5900	1	92,99	-



Miska
Bowl

Nr kat.	Ø cm	cap ml	op.	PLN	EUR
R-BANB21-6	21	1100	6	46,39	-



BANQUET

Bulionówka
Creamsoup bowl

Nr kat.	Ø cm	cap ml	op.	PLN	EUR
R-BACS18-12	8,4	180	12	20,06	-
R-BACS30-6	10,4	300	6	23,83	-

Bulionówka
Creamsoup bowl

Nr kat.	Ø cm	cap ml	op.	PLN	EUR
R-BACS02-12	10,5	300	12	30,10	-

Spodek do filiżanki / bulionówki
Saucer

Nr kat.	Ø cm	op.	PLN	EUR
R-BAST01-12	17	12	12,54	-

Bulionówka
Creamsoup bowl

Nr kat.	Ø cm	cap ml	op.	PLN	EUR
R-NAJB57-4	14	570	4	82,76	-

Sosjerka
Sauce boat

Nr kat.	cap ml	op.	PLN	EUR
R-BAGB15-6	150	6	42,63	-
R-BAGB35-4	350	4	43,89	-

Naczynie
Dish

Nr kat.	l cm	w cm	op.	PLN	EUR
R-BACD09-12	9	7	12	13,79	-

Pokrywka
Lid

Nr kat.	→ □	op.	PLN	EUR
R-BACPLD1-12	do BACP35	12	11,28	-
R-BACPLD2-12	do BACP70	12	18,81	-
R-BATPLD1-12	do BATP40	12	11,28	-
R-BATPLD2-12	do BATP80	12	18,81	-

Imbryk
Tea pot

Nr kat.	cap ml	op.	PLN	EUR
R-BATP40-4	400	4	56,43	-
R-BATP80-4	800	4	91,54	-

Imbryk
Coffee pot

Nr kat.	cap ml	op.	PLN	EUR
R-BACP35-4	350	4	56,43	-
R-BACP70-4	700	4	76,30	-





Filizanka niska sztaplowalna
Stackable low cup

Nr kat.	Ø cm	cap ml	op.	PLN	EUR
R-BACU18-12	8,5	180	12	16,30	-



Filizanka niska sztaplowalna
Stackable low cup

Nr kat.	Ø cm	cap ml	op.	PLN	EUR
R-BACU23-12	8,6	230	12	17,55	-



Kubek sztaplowalny
Stackable mug

Nr kat.	Ø cm	cap ml	op.	PLN	EUR
R-BASM30-12	7,6	300	12	27,59	-



Filizanka wysoka sztaplowalna
Stackable high cup

Nr kat.	Ø cm	cap ml	op.	PLN	EUR
R-BACU09-12	6,1	90	12	12,54	-
R-BACU20-12	7,2	200	12	20,06	-
R-BACU28-12	8,2	280	12	27,59	-



Filizanka do ristretto
Ristretto cup

Nr kat.	cap ml	op.	PLN	EUR
R-BANC07-12	70	12	13,79	-



Filizanka
Cup

Nr kat.	Ø cm	cap ml	op.	PLN	EUR
R-BANC09-12	6,8	90	12	13,79	-
R-BANC15-12	8,8	150	12	17,55	-
R-BANC22-12	9,9	220	12	23,83	-
R-BANC28-12	10,5	280	12	26,33	-



Kubek
Mug

Nr kat.	Ø cm	cap ml	op.	PLN	EUR
R-BAMG36-12	9	360	12	27,59	-



Kubek
Mug

Nr kat.	Ø cm	cap ml	op.	PLN	EUR
R-BAFMG30-6	7,5	300	6	27,59	-
R-BAFMG36-12	8,5	360	12	27,59	-
R-BAMG26-6	7,4	260	6	26,33	-
R-BAMG45-12	8,8	450	12	35,11	-



Spodek do filiżanki do espresso
Espresso cup saucer

Nr kat.	→ □	Ø cm	op.	PLN	EUR
R-BASA13-12	do R-BACU09D7-12	13	12	10,04	-



Spodek do filiżanki
Cup saucer

Nr kat.	→ □	Ø cm	op.	PLN	EUR
R-BASA15-12	do R-BACU18/20/ 23D7-12	15	12	7,52	-





Mlecznik
Milk jug

Nr kat.	cap ml	op.	PLN	EUR
R-BACR05-24	50	24	21,32	-
R-BACR15-6	150	6	22,57	-
R-BACR25-6	250	6	26,33	-
R-BACR35-6	350	6	37,61	-



Cukiernica
Sugar bowl

Nr kat.	Ø cm	cap ml	op.	PLN	EUR
R-BASU27-6	9,5	270	6	46,39	-
 R-BASULD-12	<i>pokrywka zapasowa</i>		12	10,04	-



Cukiernica
Sugar bowl

Nr kat.	l cm	h cm	w cm	cap ml	op.	PLN	EUR
R-BASH01-6	11	4	7	200	6	28,84	-



Cukiernica
Sugar bowl

Nr kat.	Ø cm	cap ml	op.	PLN	EUR
R-BASH02-12	8,5	230	12	21,32	-



Cukiernica
Sugar bowl

Nr kat.	l cm	h cm	w cm	cap ml	op.	PLN	EUR
R-BASH03-6	11	5	6	100	6	33,85	-



Naczynie
Dish

Nr kat.	Ø cm	cap ml	op.	PLN	EUR
R-BABR03-12	7	40	12	12,54	-



Naczynie
Dish

Nr kat.	Ø cm	cap ml	op.	PLN	EUR
R-BABR01-12	7	60	12	12,54	-
R-BABR02-12	8	100	12	13,79	-



Naczynie na wykałaczki
Toothpick holder

Nr kat.	Ø cm	cap ml	op.	PLN	EUR
R-BATH01-12	5,5	70	12	15,05	-



Solniczka / Pieprzniczka
Ashtray / Salt shaker

Nr kat.		op.	PLN	EUR
R-BAPS01-6	<i>pieprz</i>	6	26,33	-
R-BASS01-6	<i>sól</i>	6	26,33	-



Kieliszek na jajko
Egg cup

Nr kat.	cap ml	op.	PLN	EUR
R-BAEG01-6	45	6	16,30	-



Naczynie na masło
Butter dish

Nr kat.	l cm	w cm	op.	PLN	EUR
R-BABD11-12	11	8	12	16,30	-



Wazon
Flower vase

Nr kat.	h cm	op.	PLN	EUR
R-BAFV01-6	15,5	6	38,87	-



Serwetnik
Napkin holder

Nr kat.	h cm	w cm	op.	PLN	EUR
R-BANH01-12	7,5	10,5	12	52,66	-



Popielniczka
Ashtray

Nr kat.	Ø cm	cap ml	op.	PLN	EUR
R-BAAT01-12	11	220	12	32,60	-
R-BAAT02-12	8		12	26,33	-



 Talerz płaski
Flat plate

Nr kat.	Ø cm	op.	PLN	EUR
R-NNPR15-24	15	24	13,79	-
R-NNPR18-24	18	24	15,05	-
R-NNPR21-12	21	24	16,30	-
R-NNPR24-12	24	12	17,55	-
R-NNPR27-12	27	12	26,33	-
R-NNPR31-6	31	6	42,63	-

 Talerz / misa
Plate / Bowl

Nr kat.	Ø cm	cap ml	op.	PLN	EUR
V-BUBC26-12	26	1200	12	46,07	-
V-BUBC30-6	30	1900	6	62,21	-
R-BUBC36-1	36	3600	1	241,99	-
R-BUBC46-1	46	5750	1	317,22	-

 Talerz płaski
Flat plate

Nr kat.	l cm	w cm	op.	PLN	EUR
R-EDSQ25IV-12	25	25	12	43,89	-
R-EDSQ27IV-12	27	27	12	57,67	-
R-EDSQ30IV-6	30	30	6	67,71	-

 Talerz płaski
Flat plate

Nr kat.	l cm	w cm	op.	PLN	EUR
R-EDRG33IV-12	33,5	18	12	47,65	-

 Półmisek
Dish

Nr kat.	l cm	w cm	op.	PLN	EUR
R-NNOP21-12	21	15	12	22,57	-
R-NNOP26-12	26	19	12	31,34	-
R-NNOP32-6	32	23	6	45,14	-
R-NNOP36-6	36	27	6	48,90	-





Miska
Bowl

Nr kat.	Ø cm	cap ml	op.	PLN	EUR
R-NNRB16-12	16	580	12	21,32	-



Miska
Bowl

Nr kat.	Ø cm	cap ml	op.	PLN	EUR
R-FDBI08-12	8	110	12	16,30	-
R-FDBI11-12	11	220	12	23,83	-
R-FDBI12-12	12	280	12	25,07	-
R-FDBI14-12	14	450	12	41,38	-



Filiżanka
Cup

Nr kat.	Ø cm	cap ml	op.	PLN	EUR
R-CLCU09-12	6,4	90	12	21,32	-
R-CLCU20-12	8,3	200	12	26,33	-
R-CLCU23-12	8,4	230	12	28,84	-
R-CLCU28-12	8,8	280	12	32,60	-

Spodek do filiżanki
Saucer

Nr kat.	→ □	Ø cm	op.	PLN	EUR
R-CLSA13-12	do R-CLCU09-12	13	12	15,05	-
R-CLSA15-12	do R-CLCU20/23-12	15	12	17,55	-
R-CLSA17-12	do R-CLCU28-12,	17	12	21,32	-



Cukiernica
Sugar bowl

Nr kat.	cap ml	op.	PLN	EUR
R-NNSU25-6	250	6	42,63	-
R-NNSULD-		8		-



Łyżka azjatycka
Asian spoon

Nr kat.	l cm	op.	PLN	EUR
R-NNSP14-12	14	12	18,81	-



Talerz płaski
Flat plate

Nr kat.	Ø cm	op.	PLN	EUR
R-BAFP15D7-24	15	24	15,05	-
R-BAFP17D7-24	17	24	16,30	-
R-BAFP19D7-24	19	24	16,30	-
R-BAFP21D7-24	21	24	18,81	-
R-BAFP24D7-12	24	12	20,06	-
R-BAFP27D7-12	27	12	30,10	-
R-BAFP29D7-12	29	12	37,61	-



Talerz głęboki
Deep plate

Nr kat.	Ø cm	cap ml	op.	PLN	EUR
R-BADP23D7-12	23	265	12	20,06	-
R-BADP30D7-6	30	600	6	41,38	-



Półmisek
Dish

Nr kat.	l cm	w cm	op.	PLN	EUR
R-BAOP32D7-6	32	22	6	51,40	-
R-BAOP38D7-6	38	26	6	60,18	-



Miska
Bowl

Nr kat.	Ø cm	cap ml	op.	PLN	EUR
R-BASP16D7-12	16	670	12	20,06	-
R-BASP20D7-12	20	1050	12	47,65	-



Miska sztaplowalna
Stackable bowl

Nr kat.	Ø cm	cap ml	op.	PLN	EUR
R-BASB16D7-12	16	600	12	21,32	-
R-BASB21D7-12	21	1180	12	46,39	-



Bulionówka
Creamsoup bowl

Nr kat.	Ø cm	cap ml	op.	PLN	EUR
R-BACS02D7-12	10,5	300	12	31,34	-

Spodek do bulionówki
Saucer

Nr kat.	Ø cm	op.	PLN	EUR
R-BAST01D7-12	17	12	16,30	-

Imbryk
Tea pot

Nr kat.	cap ml	op.	PLN	EUR
R-BATP40D7-4	400	4	56,43	-

Filiżanka sztaplowalna do espresso
Espresso stackable cup

Nr kat.	Ø cm	cap ml	op.	PLN	EUR
R-BACU09D7-12	6,1	90	12	12,54	-

Filiżanka wysoka sztaplowana
Stackable high cup

Nr kat.	Ø cm	cap ml	op.	PLN	EUR
R-BACU20D7-12	7,1	200	12	20,06	-

Filiżanka niska sztaplowalna
Stackable low cup

Nr kat.	Ø cm	cap ml	op.	PLN	EUR
R-BACU18D7-12	8,4	180	12	16,30	-
R-BACU23D7-12	8,6	230	12	21,32	-

Spodek do filiżanki
Cup saucer

Nr kat.	→ □	Ø cm	op.	PLN	EUR
R-BASA13D7-12	do R-BACU09D7-12	13	12	8,78	-
R-BASA15D7-12	do R-BACU18/20/23D7-12	15	12	10,04	-

Spodek do filiżanki do espresso
Espresso cup saucer

Nr kat.	→ □	Ø cm	op.	PLN	EUR
R-BASA13-12	do R-BACU09D7-12	13	12	10,04	-

Spodek do filiżanki
Cup saucer

Nr kat.	→ □	Ø cm	op.	PLN	EUR
R-BASA15-12	do R-BACU18/20/23D7-12	15	12	7,52	-

Mlecznik
Milk jug

Nr kat.	cap ml	op.	PLN	EUR
R-BACR15D7-6	150	6	23,83	-
R-BACR25D7-6	250	6	26,33	-
R-BACR35D7-6	350	6	36,37	-

Cukiernica
Sugar bowl

Nr kat.	Ø cm	cap ml	op.	PLN	EUR
R-BASU27D7-6	9,5	270	6	46,39	-
R-BASULD-12	pokrywa zapasowa		12	10,04	-

Solniczka / Pieprzniczka
Pepper shaker / Salt shaker

Nr kat.	op.	PLN	EUR
R-BAPS01D7-6	pieprz	6	25,07
R-BASS01D7-6	sól	6	25,07



Talerz płaski
Flat plate

Nr kat.	Ø cm	op.	PLN	EUR
R-CLFP15-24	15	24	20,06	-
R-CLFP17-24	17	24	21,32	-
R-CLFP19-24	19	24	22,57	-
R-CLFP21-24	21	24	25,07	-
R-CLFP24-12	24	12	27,59	-
R-CLFP27-12	27	12	37,61	-
R-CLFP29-12	29	12	46,39	-
R-CLFP31-6	31	6	57,67	-
R-CLFP33-6	33	6	80,24	-

Talerz głęboki
Deep plate

Nr kat.	Ø cm	cap ml	op.	PLN	EUR
R-CLDP24-12	24	200	12	35,11	-
R-CLDP26-12	26	300	12	46,39	-
R-CLDP30-6	30	400	6	53,92	-

Talerz głęboki
Deep plate

Nr kat.	Ø cm	cap ml	op.	PLN	EUR
R-CLXD23-6	23	320	6	45,14	-
R-CLXD26-6	26	480	6	53,92	-

Talerz płaski
Flat plate

Nr kat.	l cm	w cm	op.	PLN	EUR
R-CLSP24-12	24	24	12	52,66	-
R-CLSP27-12	27	27	12	58,93	-
R-CLSP30-6	30	30	6	66,45	-

Talerz płaski
Flat plate

Nr kat.	l cm	w cm	op.	PLN	EUR
R-CLRP21-12	21	7	12	46,39	-
R-CLRP23-12	23	7	12	50,16	-
R-CLRP26-12	26	8	12	61,44	-
R-CLRP29-12	29	12	12	66,45	-
R-CLRP33-6	33	23	6	70,22	-
R-CLRP38-6	38	21	6	94,04	-

Talerz płaski
Flat plate

Nr kat.	l cm	w cm	op.	PLN	EUR
R-CLRP38IN3-6	39	21	6	100,31	-





Miska
Bowl

Nr kat.	l cm	h cm	w cm	cap ml	op.	PLN	EUR
R-CLSB12-12	12	4,5	12	200	12	23,83	-
R-CLSB14-12	14	4,5	14	320	12	28,84	-
R-CLSB16-12	16	4,5	16	400	12	36,37	-
R-CLSB18-12	18	4,5	18	450	12	42,63	-
R-CLSB21-6	21	4,5	21	650	6	56,43	-



Bulionówka
Creamsoup bowl

Nr kat.	Ø cm	cap ml	op.	PLN	EUR
R-BACS30-6	10,4	300	6	23,83	-



Spodek do bulionówki
Soup bowl saucer

Nr kat.	Ø cm	op.	PLN	EUR
R-CLSA01-12	15,7	12	17,55	-



Imbryk
Tea pot

Nr kat.	cap ml	op.	PLN	EUR	
R-CLTP40-4	400	4	71,46	-	
R-CLTPLD1-12	pokrywka zapasowa		12	15,05	-



Filizanka
Cup

Nr kat.	Ø cm	cap ml	op.	PLN	EUR
R-CLCU09-12	6,4	90	12	21,32	-
R-CLCU20-12	8,3	200	12	26,33	-
R-CLCU23-12	8,4	230	12	28,84	-
R-CLCU28-12	8,8	280	12	32,60	-



Spodek do filizanki / bulionówki
Espresso saucer

Nr kat.	→ □	Ø cm	op.	PLN	EUR
R-CLSA13-12	do CLCU09	13	12	15,05	-
R-CLSA15-12	do CLCU20 / 23	15	12	17,55	-
R-CLSA17-12	do CLCU28 / CLCS30	17	12	21,32	-



Mlecznik
Milk jug

Nr kat.	cap ml	op.	PLN	EUR
R-CLCR15-12	150	12	28,84	-
R-CLCR25-12	250	12	32,60	-



Cukiernica
Sugar bowl

Nr kat.	Ø cm	cap ml	op.	PLN	EUR
R-CLSU27-6	8,5	270	6	56,43	-
R-CLSULD1-12	pokrywka zapasowa		12	10,04	-



Solniczka / Pieprzniczka
Pepper shaker / Salt shaker

Nr kat.	op.	PLN	EUR
R-CLPS01-6	6	28,84	-
R-CLSS01-6	6	28,84	-





Talerz płaski
Flat plate

Nr kat.	l cm	w cm	op.	PLN	EUR
R-SKSFP17-24	17	17	24	18,81	-
R-SKSFP19-24	19	19	24	21,32	-
R-SKSFP21-12	21	21	12	26,33	-
R-SKSFP24-12	24	24	12	28,84	-
R-SKSFP27-12	27	27	12	36,37	-
R-SKSFP31-6	31	31	6	50,16	-



Talerz płaski
Flat plate

Nr kat.	Ø cm	op.	PLN	EUR
R-SKRFP22-12	22	12	25,07	-
R-SKRFP24-12	24	12	27,59	-
R-SKRFP28-12	28	12	43,89	-



Talerz głęboki
Deep plate

Nr kat.	l cm	w cm	cap ml	op.	PLN	EUR
R-SKSDP24-12	24	24	300	12	27,59	-
R-SKSDP27-12	27	27	1080	12	28,84	-



Talerz głęboki
Deep plate

Nr kat.	Ø cm	cap ml	op.	PLN	EUR
R-SKRDP22-12	22	400	12	25,07	-
R-SKRDP26-12	26	700	12	32,60	-





Talerz płaski
Flat plate

Nr kat.	l cm	w cm	op.	PLN	EUR
R-SKRP30-6	30	20	6	68,96	-



Miska
Bowl

Nr kat.	Ø cm	cap ml	op.	PLN	EUR
R-SKBWL40-12	13	400	12	18,81	-
R-SKBWL60-12	15	600	12	27,59	-



Miska
Bowl

Nr kat.	Ø cm	cap ml	op.	PLN	EUR
R-SKBWL17-12	17	450	12	26,33	-
R-SKBWL23-6	23	1000	6	31,34	-



Miska
Bowl

Nr kat.	Ø cm	cap ml	op.	PLN	EUR
R-SKSRD10-24	10	75	24	16,30	-
R-SKSRD12-24	12	180	24	20,06	-
R-SKSRD14-24	14	250	24	26,33	-
R-SKSRD16-24	16	300	24	31,34	-



Miseczka
Bowl

Nr kat.	l cm	w cm	cap ml	op.	PLN	EUR
R-SKSTD11-12	11	11	210	12	20,06	-



Naczynie
Dish

Nr kat.	l cm	w cm	cap ml	op.	PLN	EUR
R-SKRTD15-12	15	10	220	12	22,57	-





Filiżanka sztaplowalna do e
Espresso stackable cup

Nr kat.	Ø cm	cap ml	op.	PLN	EUR
R-SKCU09-12	5,9	90	12	12,54	-



Filiżanka sztaplowalna
Stackable cup

Nr kat.	Ø cm	cap ml	op.	PLN	EUR
R-SKCU23-12	8,7	230	12	18,81	-

Spodek
Saucer

Nr kat.	l cm	w cm	op.	PLN	EUR
R-SKSA12-12	12	12	12	10,04	-



Spodek
Saucer

Nr kat.	l cm	w cm	op.	PLN	EUR
R-SKSA14-12	14	14	12	11,28	-



Mlecznik
Milk jug

Nr kat.	cap ml	op.	PLN	EUR
R-SKCR15-6	150	6	22,57	-



Cukiernica
Sugar bowl

Nr kat.	cap ml	op.	PLN	EUR	
R-SKSU25-6	250	6	45,14	-	
R-SKSULD-12	pokrywka zapasowa		12	10,04	-



Solniczka / Pieprzniczka
Pepper shaker / Salt shaker

Nr kat.	op.	PLN	EUR	
R-SKPS01-6	pieprz	6	25,07	-
R-SKSS01-6	sól	6	25,07	-





Talerz płaski
Flat plate

Nr kat.	Ø cm	op.	PLN	EUR
R-FDFP16-24	16	24	32,60	-
R-FDFP22-12	22	12	41,38	-
R-FDFP25-12	25	12	46,39	-
R-FDFP27-12	27	12	51,40	-
R-FDFP29-12	29	12	60,18	-
R-FDFP31-6	31	6	66,45	-
R-FDFP33-6	33	6	82,76	-



Talerz płaski gourmet
Gourmet flat plate

Nr kat.	Ø cm	op.	PLN	EUR
R-FDGF29-12	29	12	63,95	-



Talerz głęboki
Deep plate

Nr kat.	Ø cm	cap ml	op.	PLN	EUR
R-FDDP23-12	23	360	12	42,63	-
R-FDDP31-6	31	770	6	68,96	-



Talerz głęboki
Deep plate

Nr kat.	Ø cm	cap ml	op.	PLN	EUR
R-GDDP23-6	23	220	6	60,18	-
R-GDDP29-6	29	640	6	76,49	-



Talerz głęboki gourmet
Gourmet deep plate

Nr kat.	Ø cm	cap ml	op.	PLN	EUR
R-FDGD26-6	26	1250	12	55,17	-
R-FDGD29-6	29	1650	12	63,95	-



Pokrywa do talerza gourmet
Lid for gourmet plate

Nr kat.	→ □	Ø cm	op.	PLN	EUR
R-FDCL01-6	do R-FDGD26-6	13,6	6	51,40	-
R-FDCL02-6	do R-FDGD29-6	15,5	6	55,17	-

FINE DINE

Półmisek
Dish

Nr kat.	l cm	w cm	op.	PLN	EUR
R-FDOP30-12	30	8	12	73,98	-

Półmisek
Dish

Nr kat.	l cm	w cm	op.	PLN	EUR
R-FDOP34-6	34	25,5	6	85,27	-
R-FDOP36-6	36	27	6	89,02	-

Półmisek
Dish

Nr kat.	l cm	w cm	op.	PLN	EUR
R-FDOP40-12	40	19	12	106,57	-
R-FDOP46-12	46	22	12	124,13	-

Miska
Bowl

Nr kat.	Ø cm	cap ml	op.	PLN	EUR
R-FDBI08-12	8	110	12	16,30	-
R-FDBI11-12	11	220	12	23,83	-
R-FDBI12-12	12	280	12	25,07	-
R-FDBI14-12	14	450	12	41,38	-

Miska
Bowl

Nr kat.	l cm	w cm	cap ml	op.	PLN	EUR
R-FDBO16-6	16	11	320	6	35,11	-
R-FDBO24-6	23	15,3	1110	6	77,74	-
R-FDBO27-6	27	19	1070	6	94,04	-

Miska
Bowl

Nr kat.	Ø cm	cap ml	op.	PLN	EUR
R-FDBS23-12	22,5	1400	12	60,18	-

Bulionówka
Creamsoup bowl

Nr kat.	Ø cm	cap ml	op.	PLN	EUR
R-FDCS35-6	11	350	6	43,89	-

Spodek pod bulionówkę
Soup bowl saucer

Nr kat.	Ø cm	op.	PLN	EUR
R-FDSA19-12	19	12	25,07	-

Karafka
Carrafe

Nr kat.	cap ml	op.	PLN	EUR
R-GJJU09-12	90	12	21,32	-
R-GJJU15-12	150	12	23,83	-
R-GJJU25-12	250	12	30,10	-
R-GJJU50-6	500	6	61,44	-
R-GJJU100-4	1000	4	82,76	-

Solniczka / Pieprzniczka
Pepper shaker / Salt shaker

Nr kat.	op.	PLN	EUR
R-FDPS01-6	pieprz 6	30,10	-
R-FDSS01-6	sól 6	30,10	-





Imbryk
Tea pot

Nr kat.	cap ml	op.	PLN	EUR
R-FDTP40-4	400	4	85,27	-



Filizanka
Cup

Nr kat.	cap ml	op.	PLN	EUR
R-FDCU09-12	90	12	25,07	-
R-FDCU20-12	200	12	32,60	-
R-FDCU25-12	250	12	35,11	-



Filizanka
Cup

Nr kat.	cap ml	op.	PLN	EUR
R-FDCU30-12	300	12	42,63	-



Kubek
Mug

Nr kat.	cap ml	op.	PLN	EUR
R-FDMU30-12	300	12	30,10	-



Spodek do filiżanki
Saucer

Nr kat.	→ □	Ø cm	op.	PLN	EUR
R-FDSA13-12	do R-FDCU09-12	13	12	16,30	-
R-FDSA15-12	do R-FDCU20/25-12	15	12	20,06	-
R-FDSA17-12	do R-FDCU30-12	17	12	25,07	-



Spodek do filiżanki
Saucer

Nr kat.	→ □	op.	PLN	EUR
R-OPSA12-12	do R-FDCU09-12	12	22,57	-
R-OPSA14-12	do R-FDMU30-12	12	25,07	-



Mlecznik
Milk jug

Nr kat.	cap ml	op.	PLN	EUR
R-FDCR05-24	50	24	26,33	-
R-FDCR15-6	150	6	37,61	-
R-FDCR25-6	250	6	45,14	-
R-FDCR40-6	400	6	56,43	-



Cukiernica
Sugar bowl

Nr kat.	Ø cm	cap ml	op.	PLN	EUR
R-FDSU22-6	10	220	6	56,43	-
☞ R-FDSULD-12			12	11,28	-

pokrywka zapasowa



Talerz płaski
Flat plate

Nr kat.	Ø cm	op.	PLN	EUR
R-LRFP15-24	15	24	32,60	-
R-LRFP19-24	19	24	35,11	-
R-LRFP21-12	21	12	41,38	-
R-LRFP24-12	24	12	45,14	-
R-LRFP27-12	27	12	51,40	-
R-LRFP29-12	29	12	60,18	-
R-LRFP31-6	31	6	66,45	-



Talerz głęboki
Deep plate

Nr kat.	Ø cm	cap ml	op.	PLN	EUR
R-LRDP23-12	23	300	12	42,63	-
R-LRDP26-12	26	420	12	53,92	-
R-LRDP30-6	30	600	6	68,96	-



Pokrywka do głębokiego talerza
Lid for deep plate

Nr kat.	Ø cm	h cm	PLN	EUR
R-LRCV20-1	20,5	7	62,70	-
R-LRCV23-1	23	9	73,98	-
R-LRCV27-1	27	22	90,28	-



Półmisek
Dish

Nr kat.	l cm	w cm	op.	PLN	EUR
R-LROP22-12	22	15,5	12	43,89	-



Miska sztaplowalna
Stackable bowl

Nr kat.	Ø cm	cap ml	op.	PLN	EUR
R-LRSB12-12	12	150	12	28,84	-
R-LRSB18-12	18	290	12	46,39	-



Bulionówka
Creamsoup bowl

Nr kat.	Ø cm	cap ml	op.	PLN	EUR
R-LRCN30-12	12	300	12	43,89	-

Spodek do bulionówki
Creamsoup bowl saucer

Nr kat.	Ø cm	op.	PLN	EUR
R-LRSA17-12	17	12	25,07	-



Filizanka
Cup

Nr kat.	Ø cm	cap ml	op.	PLN	EUR
R-LRCU09-12	6,7	90	12	25,07	-
R-LRCU18-12	8,9	180	12	32,60	-
R-LRCU22-12	9,8	220	12	35,11	-
R-LRCU27-12	10,2	270	12	40,12	-

Spodek do filizanki
Saucer

Nr kat.	→ □	Ø cm	op.	PLN	EUR
R-LRSA15-12	do R-LRCU18/22-12	15	12	20,06	-
R-LRSA12-12	do R-LRCU09-12	12	12	16,30	-



Imbryk
Tea pot

Nr kat.	cap ml	op.	PLN	EUR
R-LRTP40-4	400	4	85,27	-
→ R-LRTPLD-12	pokrywka zapasowa	12	17,55	-

Mlecznik
Milk jug

Nr kat.	cap ml	op.	PLN	EUR
R-LRCR15-12	150	6	37,61	-
R-LRCR25-6	250	6	45,14	-

Cukiernica
Sugar bowl

Nr kat.	cap ml	op.	PLN	EUR
R-LRSU27-6	270	6	56,43	-
R-LRSULD-12		12	11,28	-

*pokrywa
zapasowa*

Solniczka
Salt shaker

Nr kat.	op.	PLN	EUR
R-LRSS01-12	12	31,34	-

Pieprzniczka
Pepper shaker

Nr kat.	op.	PLN	EUR
R-LRPS01-12	12	31,34	-

Wazon
Flower vase

Nr kat.	Ø cm	h cm	cap ml	op.	PLN	EUR
R-LRFV01-6	3,5	14,5	445	6	40,12	-





Talerz płaski
Flat plate

Nr kat.	Ø cm	op.	PLN	EUR
R-EDFP22-12	22	12	45,14	-
R-EDFP27-12	27	12	56,43	-
R-EDFP31-6	31	6	73,98	-



Półmisek owalny
Oval dish

Nr kat.	l cm	w cm	op.	PLN	EUR
R-EDOP34-6	34	25	6	111,86	-
R-EDOP36-6	36	27	6	119,30	-

N



Talerz głęboki
Deep plate

Nr kat.	Ø cm	cap ml	op.	PLN	EUR
R-EDGD26-6	26	1200	12	62,70	-



Bulionówka
Creamsoup bowl

Nr kat.	Ø cm	h cm	cap ml	op.	PLN	EUR
R-EDCS35-6	11	6	350	6	57,95	-

N

Spodek do bulionówki
Soup bowl saucer

Nr kat.	Ø cm	op.	PLN	EUR
R-EDSA19-12	19	12	33,55	-

N



Dzbanek do kawy
Coffee pot

Nr kat.	cap ml	op.	PLN	EUR
R-EDCP35-4	350	4	111,50	-

N



Dzbanek do herbaty
Tea pot

Nr kat.	cap ml	op.	PLN	EUR
R-EDTP40-4	400	4	111,50	-

N



Filizanka
Cup

Nr kat.	Ø cm	h cm	cap ml	op.	PLN	EUR
R-EDCU30-12	9,7	7	300	12	55,34	-

Kubek
Mug

Nr kat.	Ø cm	h cm	cap ml	op.	PLN	EUR
R-EDMU30-12	8,5	8,8	300	12	39,38	-

Spodek do filiżanki/kubka
Cup saucer/mug

Nr kat.	Ø cm	op.	PLN	EUR
R-EDSA17-12	17	12	31,57	-

Spodek do filiżanki/kubka
Cup saucer/mug

Nr kat.	Ø cm	op.	PLN	EUR
R-EDSA17-12	17	12	31,57	-

Filizanka do espresso
Espresso cup

Nr kat.	Ø cm	h cm	cap ml	op.	PLN	EUR
R-EDCU09-12	5,8	7	90	12	31,57	-

Spodek do filiżanki do espresso
Saucer for espresso cup

Nr kat.	cap ml	op.	PLN	EUR
R-EDSA13-12	13	12	23,23	-

Filizanka
Cup

Nr kat.	Ø cm	h cm	cap ml	op.	PLN	EUR
R-EDCU20-12	7,7	7,8	200	12	41,62	-
R-EDCU25-12	8,4	8,3	250	12	45,30	-

Spodek do filiżanki
Cup saucer



Nr kat.	Ø cm	op.	PLN	EUR
R-EDSA15-12	15	12	27,00	-



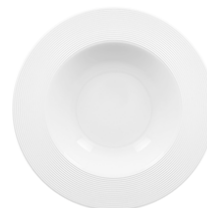

Talerz płaski
Flat plate

Nr kat.	Ø cm	op.	PLN	EUR
R-EVFP16-24	16	24	31,34	-
R-EVFP22-12	22	12	41,38	-
R-EVFP25-12	25	12	45,14	-
R-EVFP27-12	27	12	51,40	-
R-EVFP29-12	29	12	58,93	-
R-EVFP31-6	31	6	66,45	-
R-EVFP33-6	33	6	71,46	-



Talerz głęboki
Deep plate

Nr kat.	Ø cm	cap ml	op.	PLN	EUR
R-EVDP23-12	23	360	12	42,63	-
R-EVDP31-6	31	800	6	68,96	-



Talerz płaski gourmet
Gourmet flate plate

Nr kat.	Ø cm	op.	PLN	EUR
R-EVGF29-12	29	12	63,95	-



Talerz głęboki
Deep plate

Nr kat.	Ø cm	cap ml	op.	PLN	EUR
R-EVGD26-6	26	1200	6	56,43	-



Miska
Bowl

Nr kat.	Ø cm	cap ml	op.	PLN	EUR
R-EVBI12-12	12	280	12	25,07	-
R-EVBI14-12	14	450	12	41,38	-

Bulionówka
Creamsoup bowl

Nr kat.	Ø cm	cap ml	op.	PLN	EUR
R-EVCS35-6	11	350	6	43,89	-

Spodek do bulionówki
Soup bowl saucer

Nr kat.	Ø cm	op.	PLN	EUR
R-EVSA19-12	19	12	26,33	-

Kubek
Mug

Nr kat.	cap ml	op.	PLN	EUR
R-EVMU30-12	300	12	30,10	-

Spodek do filiżanki
Saucer

Nr kat.	Ø cm	op.	PLN	EUR
R-EVSA17-12	17	12	23,83	-

Filiżanka
Cup

Nr kat.	cap ml	op.	PLN	EUR
R-EVCU09-12	90	12	23,83	-
R-EVCU20-12	200	12	32,60	-
R-EVCU25-12	250	12	30,10	-
R-EVCU30-12	300	12	42,63	-

Spodek do filiżanki
Saucer

Nr kat.	→ □	Ø cm	op.	PLN	EUR
R-EVSA13-12	do R-EVCU09-12	13	12	17,55	-
R-EVSA15-12	R-EVCU20/25-12	15	12	21,32	-
R-EVSA17-12	do R-EVCU30-12	17	12	23,83	-

Mlecznik
Milk jug

Nr kat.	cap ml	op.	PLN	EUR
R-EVCR15-6	150	6	37,61	-
R-EVCR25-6	250	6	48,90	-

Cukiernica
Sugar bowl

Nr kat.	cap ml	op.	PLN	EUR
R-EVUS22-6	220	6	56,43	-





Talerz płaski
Flat plate

Nr kat.	Ø cm	op.	PLN	EUR
R-SPCP29-12	29	12	81,50	-



Naczynie
Dish

Nr kat.	cap ml	op.	PLN	EUR
R-SPCU07-12	70	12	13,79	-
R-SPCU09-12	90	12	16,30	-



Półmisek
Dish

Nr kat.	l cm	w cm	op.	PLN	EUR
R-ACDS01-6	35,5	18,5	6	82,01	-



Miseczka
Bowl

Nr kat.	Ø cm	cap ml	op.	PLN	EUR
R-SPCU18-12	8	180	12	17,55	-



Mlecznik
Milk jug

Nr kat.	h cm	w cm	cap ml	op.	PLN	EUR
R-OPSD03-12	6	5	80	12	20,06	-



Kieliszek na jajko
Egg cup

Nr kat.	h cm	w cm	cap ml	op.	PLN	EUR
R-OPEG01-12	5,2	4,9	12	12	12,54	-





Misczka
Bowl

Nr kat.	l cm	h cm	w cm	cap ml	op.	PLN	EUR
R-OPSB07-6	7	3,5	7	70	6	12,54	-
R-OPSB09-6	9	5	9	170	6	12,54	-



Naczynie na sos
Dish

Nr kat.	l cm	h cm	w cm	cap ml	op.	PLN	EUR
R-MNSD01-6	6	3	6	60	6	23,83	-



Naczynie
Dish

Nr kat.	Ø cm	cap ml	op.	PLN	EUR
R-BABR01-12	7	60	12	12,54	-
R-BABR02-12	8	100	12	13,79	-



Naczynie
Dish

Nr kat.	Ø cm	cap ml	op.	PLN	EUR
R-BABR03-12	7	40	12	12,54	-





Kieliszek na jajko
Egg cup

Nr kat.	h cm	w cm	cap ml	op.	PLN	EUR
R-OPEG01-12	5,2	4,9	12	12	12,54	-



Naczynie na wykałaczki
Toothpick holder

Nr kat.	Ø cm	cap ml	op.	PLN	EUR
R-BATH01-12	5,5	70	12	15,05	-



Naczynie na sos
Dish

Nr kat.	Ø cm	h cm	cap ml	op.	PLN	EUR
R-OPCU12-12	6,5	7	120	12	26,33	-



Naczynie
Dish

Nr kat.	l cm	h cm	w cm	cap ml	op.	PLN	EUR
R-OPSD01-12	5	5,5	5	90	12	20,06	-
R-OPSD02-12	5	4,5	5	60	12	17,55	-



Mlecznik
Milk jug

Nr kat.	h cm	w cm	cap ml	op.	PLN	EUR
R-OPSD03-12	6	5	80	12	20,06	-



Naczynie
Dish

Nr kat.	l cm	h cm	w cm	op.	PLN	EUR
R-MNTD01-6	7,5	3	6	6	23,83	-





Rondelek
Saucepan

Nr kat.	Ø cm	l cm	op.	PLN	EUR
R-MNMP01-12	6,2	10	12	19,32	-



Naczynie
Dish

Nr kat.	Ø cm	op.	PLN	EUR
R-ACY01-24	10	24	23,61	-



Łyżka azjatycka
Asian spoon

Nr kat.	l cm	op.	PLN	EUR
R-ACSP01-24	12	24	18,64	-



Naczynie na sos
Dish

Nr kat.	Ø cm	cap ml	op.	PLN	EUR
R-OPCU05-24	5,3	50	24	11,28	-



Naczynie
Dish

Nr kat.	cap ml	op.	PLN	EUR
R-SPCU07-12	70	12	13,79	-
R-SPCU09-12	90	12	16,30	-





Talerz płaski
Flat plate

Nr kat.	Ø cm	op.	PLN	EUR
R-NN24012001-12	24	12	41,38	-



Talerz płaski
Flat plate

Nr kat.	Ø cm	op.	PLN	EUR
R-NN18012001-24	18	24	35,11	-



Kubek
Mug

Nr kat.	Ø cm	cap ml	op.	PLN	EUR
R-BA26082001-6	7,6	260	6	43,89	-



Miska
Bowl

Nr kat.	Ø cm	cap ml	op.	PLN	EUR
R-BA18042001-12	18	720	12	50,16	-



Sztućce Rivoli; 18/10
Rivoli cutlery; 18/10

eternum

Nr kat.		l mm	op.	PLN	EUR
E-1921-14-12	widelec przystawkowy	179	12	9,50	-
E-1921-15-12	łyżka przystawkowa	181	12	9,50	-
E-1921-6-12	nóż przystawkowy	190	12	14,87	-





REVOL

Francuska marka Revol od lat umacnia swoją pozycję lidera w produkcji profesjonalnej porcelany dla branży horeca. Celebując swoją historię, jest kreatorem trendów i z nieustannym zapałem, unowocześnia swoje produkty, utrzymując swój unikalny styl i jakość.

For years, the French brand Revol has been strengthening its position as a leader in the production of professional porcelain for the horeca industry. Looking into the past all the time, the Revol brand eagerly modernizes its products, maintaining its creative style and the highest quality.

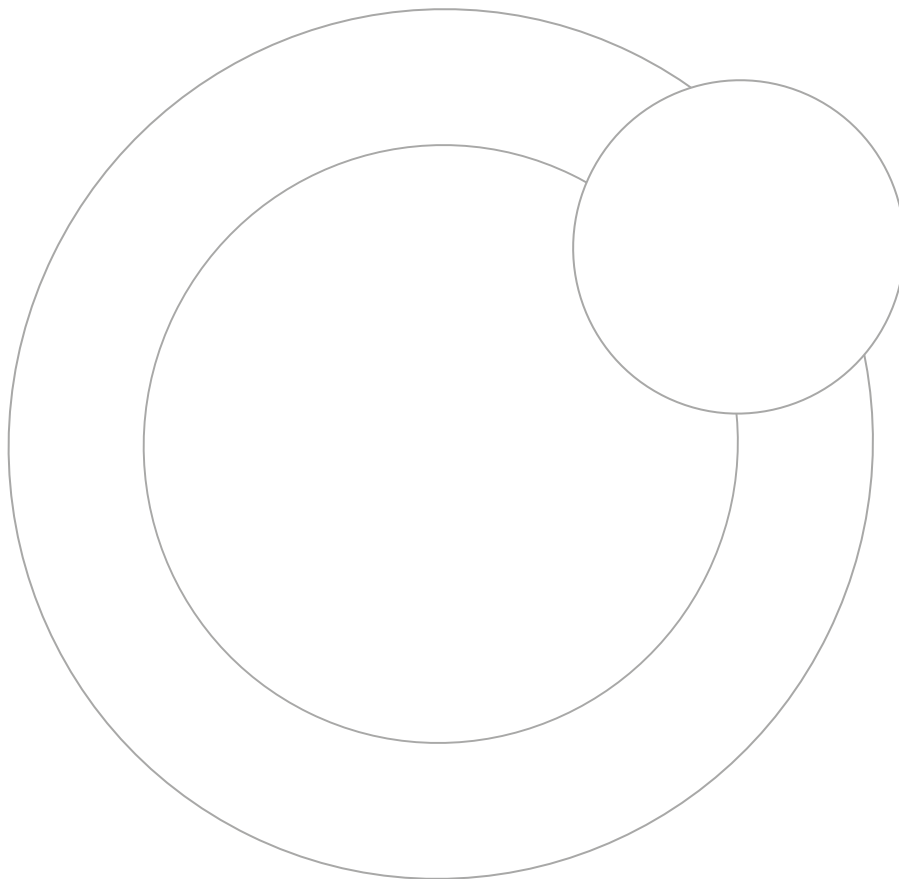

detal i szczegół

REVOL łączy bogate doświadczenie z nienasyconym pragnieniem nowoczesności i świeżości w podejściu do projektowania porcelany.

attention to detail: REVOL combines a unique experience with an insatiable desire for modernity and freshness in the approach to porcelain design.

czarna czerń

Czarna porcelana, to unikalny produkt Revol, charakteryzujący się bardzo wysoką wytrzymałością na mechaniczne uszkodzenia i środki chemiczne.

deep black: Black porcelain is a unique Revol product, characterized by very high resistance to mechanical damage and scratches.

Porcelana Revol charakteryzuje się: niską porowatością; odpornością na ułuszczenia, szok termiczny (od -40 do +300 °C), oraz dobrym przewodzeniem ciepła.

Revol porcelain is characterized by: low porosity; resistance to chipping, resistance to thermal shock (from -40 to +300 °C); it slowly gives off heat.





Talerz płaski
Flat plate

Nr kat.	Ø cm	h cm	op.	PLN	EUR
RV-652845-4	15	1,5	4	101,05	-
RV-652798-4	21	2	4	137,11	-
RV-652703-4	26	2,2	4	159,79	-
RV-652711-4	28	2,5	4	180,28	-
RV-652728-4	30	2	4	206,74	-



Talerz płaski
Flat plate

Nr kat.	Ø cm	h cm	op.	PLN	EUR
RV-652846-4	15	1,5	4	101,05	-
RV-652799-4	21	2	4	137,11	-
RV-652704-4	26	2,2	4	159,79	-
RV-652712-4	28	2,5	4	180,28	-
RV-652729-4	30	2	4	206,74	-



Talerz płaski
Flat plate

Nr kat.	Ø cm	h cm	op.	PLN	EUR
RV-652844-4	15	1,5	4	101,05	-
RV-652797-4	21	2	4	137,11	-
RV-652702-4	26	2,2	4	159,79	-
RV-652710-4	28	2,5	4	180,28	-
RV-652727-4	30	2	4	206,74	-



Talerz płaski
Flat plate

Nr kat.	Ø cm	h cm	op.	PLN	EUR
RV-652847-4	15	1,5	4	101,05	-
RV-652800-4	21	2	4	137,11	-
RV-652705-4	26	2,2	4	159,79	-
RV-652713-4	28	2,5	4	180,28	-
RV-652730-4	30	2	4	206,74	-



Talerz płaski
Flat plate

Nr kat.	Ø cm	h cm	op.	PLN	EUR
RV-652850-4	15	1,5	4	101,05	-
RV-652803-4	21	2	4	137,11	-
RV-652708-4	26	2,2	4	159,79	-
RV-652716-4	28	2,5	4	180,28	-
RV-652733-4	30	2	4	206,74	-



Talerz płaski
Flat plate

Nr kat.	Ø cm	h cm	op.	PLN	EUR
RV-652848-4	15	1,5	4	101,05	-
RV-652801-4	21	2	4	137,11	-
RV-652706-4	26	2,2	4	159,79	-
RV-652714-4	28	2,5	4	180,28	-
RV-652731-4	30	2	4	206,74	-

KUP ON-LINE



Talerz prezentacyjny
Show plate

Nr kat.	Ø cm	h cm	op.	PLN	EUR
RV-652501-2	15	5,5	2	202,36	-

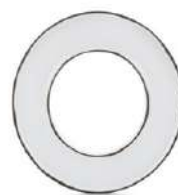

Talerz prezentacyjny
Show plate

Nr kat.	Ø cm	h cm	PLN	EUR
RV-652811-1	27,5	4	365,19	-



Półmisek
Dish

Nr kat.	l cm	h cm	w cm	op.	PLN	EUR
RV-652864-1	46,5	3	28,7	1	426,82	-



Misa
Bowl

Nr kat.	Ø cm	h cm	cap ml	PLN	EUR
RV-652890-1	32,5	8	3500	453,23	-





Talerz głęboki
Deep plate

Nr kat.	Ø cm	h cm	cap ml	op.	PLN	EUR
● RV-652742-4	23	3,3	500	4	170,19	-
○ RV-652743-4	23	3,3	500	4	170,19	-
● RV-652744-4	23	3,3	500	4	170,19	-
● RV-652745-4	23	3,3	500	4	170,19	-
● RV-652746-4	23	3,3	500	4	170,19	-
● RV-652749-4	23	3,3	500	4	170,19	-



Półmisek
Dish

Nr kat.	l cm	h cm	w cm	op.	PLN	EUR
● RV-652758-4	35,5	2,5	21,8	4	237,42	-
○ RV-652759-4	35,5	2,5	21,8	4	237,42	-
● RV-652760-4	35,5	2,5	21,8	4	237,42	-
● RV-652761-4	35,5	2,5	21,8	4	237,42	-
● RV-652762-4	35,5	2,5	21,8	4	237,42	-
● RV-652764-4	35,5	2,5	21,8	4	237,42	-



Filizanka
Cup

Nr kat.	Ø cm	h cm	cap ml	op.	PLN	EUR
● RV-653856-4	8	8	220	4	89,90	-
○ RV-653857-4	8	8	220	4	89,90	-
● RV-653858-4	8	8	220	4	89,90	-
● RV-653860-4	8	8	220	4	89,90	-
● RV-653861-4	8	8	220	4	89,90	-
● RV-653863-4	8	8	220	4	89,90	-



Spodek do filizanki 220 ml
220 ml cup saucer

Nr kat.	l cm	h cm	w cm	op.	PLN	EUR
● RV-653999-4	18	1,5	11,1	4	94,06	-
○ RV-654000-4	18	1,5	11,1	4	94,06	-
● RV-654001-4	18	1,5	11,1	4	94,06	-
● RV-654002-4	18	1,5	11,1	4	94,06	-
● RV-654003-4	18	1,5	11,1	4	94,06	-
● RV-654005-4	18	1,5	11,1	4	94,06	-



Filizanka do espresso
Espresso cup

Nr kat.	Ø cm	h cm	cap ml	op.	PLN	EUR
● RV-652686-4	5,8	5,8	80	4	62,37	-
○ RV-652687-4	5,8	5,8	80	4	62,37	-
● RV-652688-4	5,8	5,8	80	4	62,37	-
● RV-652690-4	5,8	5,8	80	4	62,37	-
● RV-652691-4	5,8	5,8	80	4	62,37	-
● RV-652693-4	5,8	5,8	80	4	62,37	-



Spodek do filizanki do espresso
Espresso cup saucer

Nr kat.	l cm	h cm	w cm	op.	PLN	EUR
● RV-652765-4	13,5	1,2	8,3	4	69,04	-
○ RV-652766-4	13,5	1,2	8,3	4	69,04	-
● RV-652767-4	13,5	1,2	8,3	4	69,04	-
● RV-652768-4	13,5	1,2	8,3	4	69,04	-
● RV-652769-4	13,5	1,2	8,3	4	69,04	-
● RV-652771-4	13,5	1,2	8,3	4	69,04	-





Talerzyk gourmet
Gourmet plate

Nr kat.	Ø cm	h cm	cap ml	op.	PLN	EUR
● RV-653977-4	14	5	350	4	115,08	-
○ RV-653978-4	14	5	350	4	115,08	-
● RV-653979-4	14	5	350	4	115,08	-
● RV-653980-4	14	5	350	4	115,08	-
● RV-653981-4	14	5	350	4	115,08	-
● RV-653983-4	14	5	350	4	115,08	-



Miska
Bowl

Nr kat.	Ø cm	h cm	cap ml	op.	PLN	EUR
● RV-653929-4	11	7	440	4	111,72	-
○ RV-653930-4	11	7	440	4	111,72	-
● RV-653931-4	11	7	440	4	111,72	-
● RV-653932-4	11	7	440	4	111,72	-
● RV-653933-4	11	7	440	4	111,72	-
● RV-653935-4	11	7	440	4	111,72	-

Miseczka
Bowl

Nr kat.	Ø cm	h cm	cap ml	op.	PLN	EUR
● RV-653961-6	7	2	34	6	58,53	-
○ RV-653962-6	7	2	34	6	58,53	-
● RV-653963-6	7	2	34	6	58,53	-
● RV-653964-6	7	2	34	6	58,53	-
● RV-653965-6	7	2	34	6	58,53	-
● RV-653967-6	7	2	34	6	58,53	-

Naczynie
Dish

Nr kat.	Ø cm	l cm	h cm	w cm	cap ml	op.	PLN	EUR
○ RV-654572-4	14	16	3	14	100	4	100,99	-
● RV-654571-4	14	16	3	14	100	4	100,99	-
● RV-654573-4	14	16	3	14	100	4	100,99	-
● RV-654574-4	14	16	3	14	100	4	100,99	-

Naczynie nadaje się do serwowania dań oraz zapiekania w piekarniku
Dish can be used for serving and for baking in the oven

Garnuszek z pokrywą
Mini pot with lid

Nr kat.	Ø cm	l cm	h cm	w cm	cap ml	op.	PLN	EUR
○ RV-654576-6	12	14	6,5	12	250	6	205,70	-
● RV-654575-6	12	14	6,5	12	250	6	205,70	-
● RV-654577-6	12	14	6,5	12	250	6	205,70	-
● RV-654579-6	12	14	6,5	12	250	6	205,70	-

Naczynie nadaje się do serwowania dań oraz zapiekania w piekarniku
Dish can be used for serving and for baking in the oven

Naczynie/Brytfana
Dish/Oven pan

Nr kat.	l cm	h cm	w cm	cap ml	op.	PLN	EUR
○ RV-654567-6	16	4,5	11	300	6	118,29	-
● RV-654564-6	16	4,5	11	300	6	118,29	-
● RV-654568-6	16	4,5	11	300	6	118,29	-
● RV-654569-6	16	4,5	11	300	6	118,29	-

Naczynie nadaje się do serwowania dań oraz zapiekania w piekarniku
Dish can be used for serving and for baking in the oven

Naczynie/Brytfana
Dish/Oven pan

Nr kat.	l cm	h cm	w cm	cap ml	op.	PLN	EUR
○ RV-654547-2	26	6	18,5	1300	2	242,75	-
● RV-654546-2	26	6	18,5	1300	2	242,75	-
● RV-654548-2	26	6	18,5	1300	2	242,75	-
● RV-654549-2	26	6	18,5	1300	2	242,75	-

Naczynie nadaje się do serwowania dań oraz zapiekania w piekarniku
Dish can be used for serving and for baking in the oven

Naczynie/Brytfana
Dish/Oven pan

Nr kat.	l cm	h cm	w cm	cap ml	op.	PLN	EUR
○ RV-654543-1	34	6,5	25	2800	1	350,21	-
● RV-654542-1	34	6,5	25	2800	1	350,21	-
● RV-654544-1	34	6,5	25	2800	1	350,21	-
● RV-654545-1	34	6,5	25	2800	1	350,21	-

Naczynie nadaje się do serwowania dań oraz zapiekania w piekarniku
Dish can be used for serving and for baking in the oven





No.W

PORCELANA No Waste
Wykonana z przetworzonej
porcelany i emalii.

No.W



Talerz płaski
Flat plate

Nr kat.	Ø cm	h cm	op.	PLN	EUR
RV-654618-6	21	1,8	6	95,55	-
RV-654612-6	26	1,5	6	110,28	-
RV-654609-6	28,5	2	6	124,22	-



Talerz płaski
Flat plate

Nr kat.	Ø cm	h cm	op.	PLN	EUR
RV-654619-6	21	1,8	6	105,80	-
RV-654613-6	26	1,5	6	122,08	-
RV-654610-6	28,5	2	6	139,25	-



Talerz płaski
Flat plate

Nr kat.	Ø cm	h cm	op.	PLN	EUR
RV-654620-6	21	1,8	6	105,80	-
RV-654614-6	26	1,5	6	122,08	-
RV-654611-6	28,5	2	6	139,25	-



Talerz głęboki
Deep plate

Nr kat.	Ø cm	h cm	cap ml	op.	PLN	EUR
RV-654621-6	21	3,8	350	6	104,94	-



Talerz głęboki
Deep plate

Nr kat.	Ø cm	h cm	cap ml	op.	PLN	EUR
RV-654622-6	21	3,8	350	6	113,85	-



Talerz głęboki
Deep plate

Nr kat.	Ø cm	h cm	cap ml	op.	PLN	EUR
RV-654623-6	21	3,8	350	6	113,85	-



Półmisek
Dish

Nr kat.	l cm	h cm	w cm	op.	PLN	EUR
RV-654807-3	33	2,4	24	3	158,14	-

Miska
Bowl

Nr kat.	Ø cm	h cm	cap ml	op.	PLN	EUR
● RV-654624-6	17,3	6	550	6	69,25	-
○ RV-654625-6	17,3	6	550	6	78,11	-
● RV-654626-6	17,3	6	550	6	78,11	-

Kubek
Cup

Nr kat.	Ø cm	h cm	cap ml	op.	PLN	EUR
RV-654813-6	7,9	9	330	6	133,01	-

Zestaw 2 kubków do espresso
Set of 2 espresso cup

Nr kat.	Ø cm	h cm	cap ml	op.	PLN	EUR
RV-654762-SET	6,2	6	80	2	117,37	-
RV-654769-SET	8	7,3	200	2	144,05	-

Kubek
Cup

Nr kat.	Ø cm	h cm	cap ml	op.	PLN	EUR
RV-654814-6	7,9	9	330	6	147,84	-

Zestaw 2 kubków do espresso
Set of 2 espresso cup

Nr kat.	Ø cm	h cm	cap ml	op.	PLN	EUR
RV-654764-SET	6,2	6	80	2	125,38	-
RV-654772-SET	8	7,3	200	2	160,06	-

Kubek
Cup

Nr kat.	Ø cm	h cm	cap ml	op.	PLN	EUR
RV-654815-6	7,9	9	330	6	147,84	-

Zestaw 2 kubków do espresso
Set of 2 espresso cup

Nr kat.	Ø cm	h cm	cap ml	op.	PLN	EUR
RV-654766-SET	6,2	6	80	2	125,38	-
RV-654774-SET	8	7,3	200	2	160,06	-





Talerz płaski
Flat plate

Nr kat.	l cm	h cm	w cm	op.	PLN	EUR
RV-652403-4	21	1,5	17,5	4	139,04	-



Talerz płaski
Flat plate

Nr kat.	l cm	h cm	w cm	op.	PLN	EUR
RV-652400-4	21	1,5	17,5	4	199,11	-
RV-652420-4	30	1,6	13,5	4	214,26	-



Miseczka
Bowl

Nr kat.	Ø cm	h cm	cap ml	op.	PLN	EUR
RV-652328-6	7,3	3,4	70	6	109,00	-
RV-652335-6	8,8	4	120	6	124,10	-
RV-652342-6	12,6	5,6	400	6	154,08	-



Miseczka
Bowl

Nr kat.	Ø cm	h cm	cap ml	op.	PLN	EUR
RV-652330-6	7,3	3,4	70	6	95,18	-
RV-652336-6	8,8	4	120	6	117,00	-
RV-652343-6	12,6	5,6	400	6	132,10	-



Miseczka
Bowl

Nr kat.	Ø cm	h cm	cap ml	op.	PLN	EUR
RV-652331-6	7,3	3,4	70	6	101,42	-
RV-652337-6	8,8	4	120	6	116,47	-
RV-652344-6	12,6	5,6	400	6	139,04	-





REAL GOLD



REAL GOLD

Talerz głęboki
Deep plate

Nr kat.	Ø cm	h cm	cap ml	op.	PLN	EUR
RV-651567-4	30,3	5	180	4	502,36	-

Talerz Sphere Real Gold Tempo 2
Plate Sphere Real Gold Tempo 2

Nr kat.	Ø cm	h cm	cap ml	op.	PLN	EUR
RV-651568-4	30,3	5	180	4	502,36	-

Talerz Sphere Black ink
Plate Sphere Black ink

Nr kat.	Ø cm	h cm	cap ml	op.	PLN	EUR
RV-653443-4	30,3	5	180	4	415,88	-



REAL GOLD

REAL SILVER



Talerz płaski
Deep plate

Nr kat.	Ø cm	op.	PLN	EUR
RV-648279-6	28	6	208,74	-
RV-648324-2	31	2	224,15	-

Talerz płaski
Flat plate

Nr kat.	Ø cm	op.	PLN	EUR
RV-648603-2	31	2	584,63	-

Rant talerza zdobiony złotem
Plate's edge decorated with gold



Talerz płaski
Flat plate

Nr kat.	Ø cm	op.	PLN	EUR
RV-648604-2	31	2	472,70	-

Rant talerza zdobiony srebrem
Plate's edge decorated with silver



Talerz płaski
Flat plate

Nr kat.	Ø cm	op.	PLN	EUR
RV-648280-6	28	6	208,74	-
RV-648325-2	31	2	224,15	-

Talerz płaski
Deep plate

Nr kat.	Ø cm	op.	PLN	EUR
RV-648281-6	28	6	208,74	-
RV-648326-2	31	2	224,15	-

Talerz głęboki
Deep plate

Nr kat.	Ø cm	h cm	col	op.	PLN	EUR
RV-648288-6	24	5,7	Ivory	6	188,85	-



Talerz głęboki
Deep plate

Nr kat.	Ø cm	h cm	cap ml	op.	PLN	EUR
RV-648289-6	24	5,7	1000	6	188,85	-



Talerz głęboki
Deep plate

Nr kat.	Ø cm	h cm	cap ml	op.	PLN	EUR
RV-648290-6	24	5,7	1000	6	188,85	-



Miseczka
Bowl

Nr kat.	Ø cm	h cm	cap ml	op.	PLN	EUR
● RV-648398-6	7	2	20	6	59,91	-
● RV-648400-6	7	2	20	6	59,91	-
● RV-648399-6	7	2	20	6	59,91	-



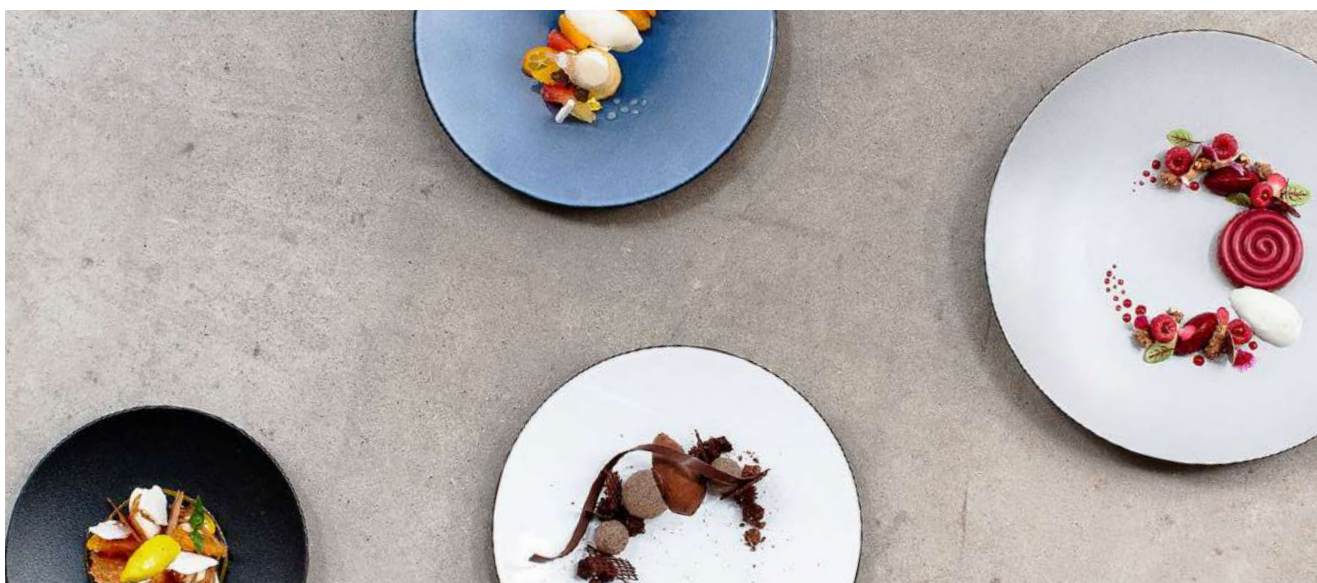

Talerz płaski
Flat plate

Nr kat.	Ø cm	h cm	op.	PLN	EUR
RV-651435-6	16	2	6	94,91	-
RV-651436-6	21,5	2,5	6	120,26	-
RV-651437-6	24	3	6	142,77	-
RV-651438-6	26	3	6	154,61	-
RV-651439-6	28	3,3	6	179,48	-
RV-651429-2	31,5	3,5	2	202,58	-



Talerz płaski
Flat plate

Nr kat.	Ø cm	op.	PLN	EUR
RV-649493-6	16	6	108,68	-
RV-649496-6	21,5	6	130,77	-
RV-650432-6	24	6	154,13	-
RV-650423-6	26	6	164,48	-
RV-649500-6	28	6	191,85	-
RV-649503-2	31,5	2	223,28	-



Talerz płaski
Flat plate

Nr kat.	Ø cm	op.	PLN	EUR
RV-649491-6	16	6	94,91	-
RV-649494-6	21,5	6	120,26	-
RV-650431-6	24	6	142,77	-
RV-650421-6	26	6	154,61	-
RV-649497-6	28	6	179,48	-
RV-649501-2	31,5	2	202,58	-



Talerz płaski
Flat plate

Nr kat.	Ø cm	op.	PLN	EUR
RV-649492-6	16	6	94,91	-
RV-649495-6	21,5	6	120,26	-
RV-650430-6	24	6	142,77	-
RV-650420-6	26	6	154,61	-
RV-649499-6	28	6	179,48	-
RV-649502-2	31,5	2	202,58	-



Talerz głęboki
Deep plate

Nr kat.	Ø cm	h cm	cap ml	op.	PLN	EUR
RV-651441-6	19	6,5	700	6	133,22	-
RV-651442-6	24	5,5	1000	6	165,02	-
RV-651430-4	27	5	1300	4	180,92	-
RV-652887-2	33,5	9	3500	2	317,98	-



Talerz głęboki
Deep plate

Nr kat.	Ø cm	h cm	cap ml	op.	PLN	EUR
RV-649579-6	19	6,5	700	6	148,00	-
RV-649506-6	24	5,5	1000	6	175,95	-
RV-649559-4	27	5	1300	4	197,24	-



Talerz głęboki
Deep plate

Nr kat.	Ø cm	h cm	cap ml	op.	PLN	EUR
RV-649577-6	19	6,5	700	6	133,22	-
RV-649504-6	24	5,5	1000	6	165,02	-
RV-649558-4	27	5	1300	4	180,92	-
RV-652885-2	33,5	9	3500	2	317,98	-



Talerz głęboki
Deep plate

Nr kat.	Ø cm	h cm	cap ml	op.	PLN	EUR
RV-649578-6	19	6,5	700	6	133,22	-
RV-649505-6	24	5,5	1000	6	165,02	-
RV-649557-4	27	5	1300	4	180,92	-



Pótmisek
Dish

Nr kat.	l cm	h cm	w cm	op.	PLN	EUR
○ RV-649567-4	32,5	1,8	15	4	157,01	-
● RV-649568-4	32,5	1,8	15	4	179,00	-
● RV-649566-4	32,5	1,8	15	4	157,01	-



Pótmisek
Dish

Nr kat.	l cm	h cm	w cm	op.	PLN	EUR
RV-651432-4	32,5	1,8	15	4	157,01	-
RV-653078-1	55,5	3	28	1	543,82	-

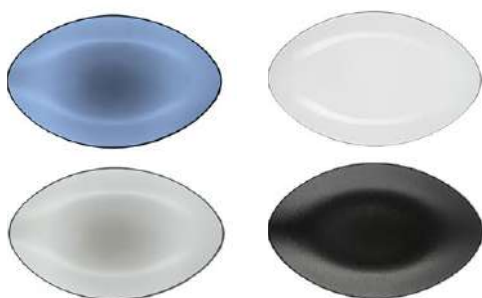

Pótmisek
Dish

Nr kat.	l cm	w cm	op.	PLN	EUR
● RV-649556-4	35	22,3	4	199,00	-
○ RV-651431-4	35	22,3	4	182,94	-
● RV-649555-4	35	22,3	4	182,94	-
● RV-649554-4	35	22,3	4	182,94	-



Dim Sum
Dim Sum

Nr kat.	Ø cm	h cm	PLN	EUR
RV-649523-1	22	13	371,01	-



Miska
BowI

Nr kat.	Ø cm	h cm	cap ml	op.	PLN	EUR
RV-651445-6	12	6,5	300	6	87,12	-



Miska
BowI

Nr kat.	Ø cm	h cm	cap ml	op.	PLN	EUR
RV-649596-6	12	6,5	300	2	101,10	-



Miska
BowI

Nr kat.	Ø cm	h cm	cap ml	op.	PLN	EUR
RV-649594-6	12	6,5	300	2	87,12	-



Miska
BowI

Nr kat.	Ø cm	h cm	cap ml	op.	PLN	EUR
RV-649595-6	12	6,5	300	6	87,12	-



Miseczka
BowI

Nr kat.	Ø cm	h cm	cap ml	op.	PLN	EUR
RV-651433-4	10,5	8	250	4	72,40	-



Miseczka
BowI

Nr kat.	Ø cm	h cm	cap ml	op.	PLN	EUR
RV-649610-4	10,5	8	250	4	72,40	-





Dzbanuszek
Jug

Nr kat.	l cm	h cm	w cm	cap ml	op.	PLN	EUR
○ RV-644306-4	8,8	13	8	250	4	95,77	-
● RV-644378-4	8,8	13	8	250	4	102,06	-
● RV-644386-4	8,8	13	8	250	4	102,06	-



Dzbanek
Jug

Nr kat.	l cm	h cm	w cm	cap ml	op.	PLN	EUR
○ RV-644303-4	11	16,2	10	500	4	114,87	-
● RV-644346-4	11	16,2	10	500	4	127,40	-
● RV-644387-4	11	16,2	10	500	4	127,40	-



Butelka z nalewakiem
Bottle with pourer

Nr kat.	l cm	h cm	w cm	cap l	op.	PLN	EUR
RV-645302-6	8,3	16,5	7,9	0,25	2	133,49	-





Talerz głęboki
Deep plate

Nr kat.	Ø cm	h cm	cap ml	op.	PLN	EUR
● RV-649100-4	23,5	4,5	700	4	159,90	-
● RV-651961-4	27	3,5	1000	4	186,21	-
○ RV-649099-4	23,5	4,5	700	4	159,90	-
○ RV-651960-4	27	3,5	1000	4	186,21	-
● RV-649101-4	23,5	4,5	700	4	159,90	-
● RV-651962-4	27	3,5	1000	4	186,21	-



Talerz płaski
Flat plate

Nr kat.	l cm	h cm	w cm	op.	PLN	EUR
RV-647363-4	31	2	11	4	106,28	-



Naczynie
Dish

Nr kat.	l cm	w cm	op.	PLN	EUR
RV-645765-6	8,5	5	6	39,59	-
RV-645768-6	15	5	6	46,90	-
RV-645866-6	27,3	5	6	63,86	-



Miseczka
Bowl

Nr kat.	Ø cm	h cm	cap ml	op.	PLN	EUR
○ RV-645843-6	7,5	5,3	40	6	66,58	-
● RV-645844-6	7,5	5,3	40	6	66,58	-
● RV-645845-6	7,5	5,3	40	6	66,58	-



Miseczka
Bowl

Nr kat.	Ø cm	h cm	cap ml	op.	PLN	EUR
○ RV-646421-6	8	6	150	6	61,03	-
● RV-646422-6	8	6	150	6	61,03	-
● RV-646423-6	8	6	150	6	61,03	-



Miseczka
Bowl

Nr kat.	Ø cm	h cm	cap ml	op.	PLN	EUR
○ RV-647322-6	5	3,5	30	6	42,36	-
● RV-647323-6	5	3,5	30	6	42,36	-
● RV-647324-6	5	3,5	30	6	42,36	-
○ RV-646398-6	11	6,7	300	6	79,12	-
● RV-646399-6	11	6,7	300	6	79,12	-
● RV-646400-6	11	6,7	300	6	79,12	-





Naczynie
Dish

Nr kat.	Ø cm	h cm	cap l	op.	PLN	EUR
RV-651952-4	18	3,5	0,45	4	116,47	-



Naczynie
Dish

Nr kat.	l cm	h cm	w cm	cap ml	op.	PLN	EUR
RV-651704-4	20	4	11	200	4	81,84	-



Garnuszek
Mini pot

Nr kat.	Ø cm	h cm	cap ml	op.	PLN	EUR
RV-641637-4	10	7	200	4	106,70	-
RV-643711-4	10	2		4	68,61	-



Naczynie
Dish

Nr kat.	l cm	h cm	w cm	cap ml	op.	PLN	EUR
RV-642075-6	7	3,5	7	80	6	55,86	-
RV-642970-4	13	4,1	13	350	4	89,52	-





Garnuszek
Mini pot

Nr kat.	Ø cm	h cm	cap ml	op.	PLN	EUR
RV-643721-4	10	5	200	4	70,42	-



Garnuszek
Mini pot

Nr kat.	Ø cm	h cm	cap ml	op.	PLN	EUR
RV-644665-4	12	5	290	4	83,76	-



Garnuszek
Mini pot

Nr kat.	Ø cm	h cm	cap ml	op.	PLN	EUR
RV-644754-4	20	7	1000	4	170,14	-



Garnuszek
Mini pot

Nr kat.	Ø cm	h cm	cap ml	op.	PLN	EUR
RV-642081-2	18,5	5,5	1000	2	155,63	-



Garnuszek
Mini pot

Nr kat.	l cm	h cm	w cm	cap ml	op.	PLN	EUR
RV-642087-4	18	4,5	12	400	4	100,20	-



Garnuszek
Mini pot

Nr kat.	l cm	h cm	w cm	cap ml	op.	PLN	EUR
RV-642065-3	19	5	12,5	700	3	115,51	-





Bulionówka
Creamsoup bowl

Nr kat.	Ø cm	h cm	cap ml	op.	PLN	EUR
RV-646139-6	12,5	9,6	450	6	117,21	-



Rondelek
Mini saucepan

Nr kat.	Ø cm	h cm	cap ml	op.	PLN	EUR
RV-644705-6	6,4	2,5	20	6	39,37	-
RV-643510-6	10,5	4,5	200	6	67,86	-



Miska
Bowl

Nr kat.	Ø cm	h cm	cap ml	op.	PLN	EUR
RV-651841-6	14	2,5	160	6	63,44	-



Talerz na ślimaki
Snail dish

Nr kat.	l cm	h cm	w cm	op.	PLN	EUR
RV-642096-6	14	3,7	12,7	6	102,22	-



Naczynie
Dish

Nr kat.	Ø cm	h cm	cap ml	op.	PLN	EUR
RV-635300-2	18,5	5	1000	2	157,98	-



Ramekin
Ramekin

Nr kat.	Ø cm	h cm	cap ml	op.	PLN	EUR
RV-644695-6	9,4	4,3	170	6	46,52	-



Naczynie
Dish

Nr kat.	Ø cm	h cm	cap ml	op.	PLN	EUR
RV-647670-12	6,3	2	20	12	28,76	-



Miseczka
Bowl

Nr kat.	Ø cm	h cm	cap ml	op.	PLN	EUR
● RV-640177-6	6,5	3,5	60	6	29,82	-
● RV-644719-6	6,5	3,5	60	6	29,82	-





Talerz płaski
Flat plate

Nr kat.	l cm	w cm	op.	PLN	EUR
RV-646118-4	32	21	4	127,78	-



Talerz płaski
Flat plate

Nr kat.	l cm	w cm	op.	PLN	EUR
RV-646319-4	36	15	4	147,46	-
RV-646321-4	36	21	4	168,43	-
RV-647934-6	24	12,5	6	114,55	-
RV-650387-4	48	21	4	265,00	-



Naczynie
Dish

Nr kat.	l cm	w cm	op.	PLN	EUR
RV-647928-2	33,2	7,8	2	121,22	-



Półmisek
Dish

Nr kat.	l cm	w cm	cap ml	op.	PLN	EUR
RV-647915-6	19	13	300	6	80,03	-
RV-648010-6	20,7	14,4	450	6	87,76	-



Talerz głęboki
Deep plate

Nr kat.	l cm	w cm	cap ml	op.	PLN	EUR
RV-647672-4	20,4	20	750	4	119,40	-



Talerz płaski
Flat plate

Nr kat.	l cm	w cm	op.	PLN	EUR
RV-647932-6	26,4	25,5	6	154,03	-



Miseczka; porcelana
Bowl; porcelain

Nr kat.	l cm	w cm	cap ml	op.	PLN	EUR
RV-648823-12	8	8	80	12	46,04	-



Miska
Bowl

Nr kat.	l cm	h cm	w cm	cap ml	op.	PLN	EUR
RV-647924-4	14,5	6	14	450	4	77,47	-





Talerz płaski
Flat plate

Nr kat.	Ø cm	h cm	op.	PLN	EUR
RV-647911-2	30	0,7	2	149,01	-



Talerz płaski
Flat plate

Nr kat.	Ø cm	h cm	op.	PLN	EUR
RV-641316-4	28,5	1,5	4	132,95	-
RV-641010-2	32	1,5	2	159,95	-



Półmisek owalny
Oval dish

Nr kat.	l cm	h cm	w cm	op.	PLN	EUR
RV-654185-4	35	1,5	22,9	4	179,42	-



Miska
Bowl

Nr kat.	Ø cm	cap ml	op.	PLN	EUR
RV-642496-4	17	700	4	79,17	-
RV-650957-2	22	1000	2	131,83	-
RV-654024-4	27	1500	4	142,88	-



Miseczka
Bowl

Nr kat.	Ø cm	cap ml	op.	PLN	EUR
RV-643599-6	7,5	80	6	41,67	-
RV-642035-6	10	250	6	50,74	-
RV-649059-6	14	600	6	71,87	-



Miseczka
Bowl

Nr kat.	Ø cm	cap ml	op.	PLN	EUR
RV-644296-6	5	30	6	28,97	-



BASALT

Talerz płaski
Flat plate

Nr kat.	l cm	w cm	op.	PLN	EUR
RV-641007-6	20	20	6	92,57	-
RV-641004-6	25	25	6	127,40	-
RV-641913-3	30	30	3	206,37	-

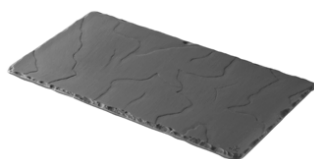
Talerz płaski
Flat plate

Nr kat.	l cm	w cm	op.	PLN	EUR
RV-640605-6	30	16	6	87,71	-

Talerz płaski
Flat plate

Nr kat.	l cm	w cm	op.	PLN	EUR
RV-641001-6	30	20	6	124,36	-

Talerz płaski
Flat plate

Nr kat.	l cm	w cm	op.	PLN	EUR
RV-640669-6	20	10	6	51,48	-
RV-640602-6	30	11	6	77,04	-

Talerz płaski
Flat plate

Nr kat.	l cm	w cm	op.	PLN	EUR
RV-640595-6	25	12	6	71,12	-

Talerz bufetowy GN 2/4
Buffet plate GN 2/4

Nr kat.	l cm	w cm	op.	PLN	EUR
RV-644986-2	54	16,5	2	232,45	-

Talerz z wycięciem na kubek
Plate with cup place

Nr kat.	l cm	w cm	op.	PLN	EUR
RV-647782-3	33	22	3	147,68	-

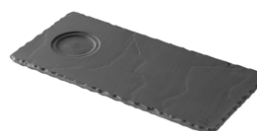
Talerz z wycięciem na kubek
Plate with cup place

Nr kat.	l cm	w cm	op.	PLN	EUR
RV-640692-6	25	12	6	71,76	-

Naczynie
Bowl

Nr kat.	l cm	h cm	w cm	cap ml	op.	PLN	EUR
RV-654189-4	18,3	3,5	13	210	4	81,84	-
RV-654192-4	24,7	4	18	450	4	105,37	-

Podstawa pod łyżkę
Spoon holder

Nr kat.	l cm	w cm	op.	PLN	EUR
RV-644293-3	19,7	10,4	3	96,67	-





pasujące elementy:
RV-642035-6
RV-641007-6

Deska; bambus
Tray; bamboo

Nr kat.	l cm	w cm	op.	PLN	EUR
RV-645196-6	37	24	6	147,79	-



pasujące elementy:
RV-640602-6

Deska; akacja
Tray; acacia

Nr kat.	l cm	w cm	op.	PLN	EUR
RV-649182-3	43	14	3	96,22	-



pasujące elementy:
RV-645059-6
RV-641001-6

Deska; akacja
Tray; acacia

Nr kat.	l cm	w cm	op.	PLN	EUR
RV-649181-3	43	23	3	121,39	-



pasujące elementy:
RV-641004-6

Deska; bambus
Tray; bamboo

Nr kat.	l cm	w cm	op.	PLN	EUR
RV-641794-6	29,2	29,2	6	164,16	-



pasujące elementy:
RV-646120-6
RV-640605-6

Deska; bambus
Tray; bamboo

Nr kat.	l cm	w cm	op.	PLN	EUR
RV-641792-6	34	19,5	6	116,63	-



pasujące elementy:
RV-640595-6
RV-640692-6

Deska; bambus
Tray; bamboo

Nr kat.	l cm	w cm	op.	PLN	EUR
RV-645200-6	28,5	15	6	78,96	-



pasujące elementy:
RV-647911-2

Deska; bambus
Tray; bamboo

Nr kat.	Ø cm	PLN	EUR
RV-649164-2	34	197,99	-



pasujące elementy:
RV-654185-4

Deska owalna; bambus
Oval tray; bamboo

Nr kat.	l cm	h cm	w cm	op.	PLN	EUR
RV-654186-4	36,5	2,5	25	4	239,28	-



DODATKI STOŁOWE

- zaskakujące wykończenie
- podkreśl swój styl



de Buyer

Rondel; miedź, 18/10
Saucepan; copper, 18/10

Nr kat.	Ø cm	h cm	cap ml	thk mm	PLN	EUR
D-6453-09	9	4,8	300	1	463,48	-

90% miedź, 10% stal nierdzewna
90% copper, 10% stainless steel



Koszyk do serwowania; 18/10
Basket; 18/10

Nr kat.	l cm	h cm	w cm	cap ml	PLN	EUR
TF-4020	10		9	350	60,85	-
V-1070		7			27,66	-
V-1080	10	7	8		27,17	-
V-2513	25,5	4	13		45,08	-



Koszyk do serwowania; 18/10, PVD
Basket; 18/10, PVD

Nr kat.	l cm	h cm	w cm	PLN	EUR
TF-613	26	5	13,5	101,84	-
TF-622	10	6,5	8,5	79,55	-
TF-623	13	9	10,5	98,13	-



100%Chef

Papier do serwowania
Serving paper

Nr kat.		l cm	w cm	PLN	EUR
C1-1089	De Vanguardia	29	30	201,40	-
C1-1090	New Fork Times	29	30	201,40	-

Opakowanie 500 sztuk • Druk nietoksyczny • Odporny na tłuszcz
Packing 500 pieces • Non-toxic printing • Resistant to fat



BAR
PROFESSIONAL

N

Wiaderko do serwowania; stal ocynkowana
Serving bucket; galvanized steel

Nr kat.	Ø cm	h cm	PLN	EUR
BPR-CUP1010	10	10	19,00	-

BAR
PROFESSIONAL

N

Pojemnik do serwowania; stal ocynkowana
Serving container; galvanized steel

Nr kat.	l cm	h cm	w cm	PLN	EUR
BPR-TUB1523	23	7	15	38,73	-



Wiaderka do serwowania; 18/10
Buckets; 18/10

Nr kat.	Ø cm	h cm	cap l	op.	PLN	EUR
TF-460	7	6,5	0,15	4	65,85	-
TF-461	9	8,5	0,33	1	23,57	-



100%Chef

Talerz- Bordeaux; szkło
Plate - Bordeaux; glass

Nr kat.	l cm	h cm	w cm	op.	PLN	EUR
C1-1087-6	30	3	8	6	110,76	-

Naczynie jest stabilne, posiada wyprofilowane dno/spód
The vessel is stable, has a contoured bottom



Kubek do serwowania; 18/10
Bucket; 18/10, PVD

Nr kat.	Ø cm	h cm	cap l	PLN	EUR
TF-467	8,5	8,5	0,35	22,42	-



Kubek do serwowania; 18/10, PVD
Bucket; 18/10, PVD

Nr kat.	Ø cm	h cm	cap l	PLN	EUR
TF-618	8,5	8,5	0,35	25,65	-



BarEq



Podkładka; drewno
Pad; wood

Nr kat.	l cm	h cm	w cm	PLN	EUR
T-TBD003	12	0,8	8	14,84	-

BarEq



Podkładka; tworzywo
Pad; plastic

Nr kat.	l cm	w cm	PLN	EUR
T-TBD004	10	10	9,08	-

100%Chef



Pokrywa do aromatyzowania; szkło borosilikatowe
Cover; borosilicate glass

Nr kat.	Ø cm	h cm	op.	PLN	EUR
C1-1013-6	14	14	6	173,78	-
C1-1015-6	18	15	6	214,20	-
C1-1022-6	9	9	6	113,17	-



100%Chef



Pokrywa do aromatyzowania; szkło borosilikatowe
Cover; borosilicate glass

Nr kat.	Ø cm	h cm	PLN	EUR
C1-1035	18,5	25	444,59	-



100%Chef



Nitro Bowl XXL; szkło borosilikatowe
Nitro Bowl XXL; borosilicate glass

Nr kat.	Ø cm	cap l	PLN	EUR
C1-1229	22	2,5	717,40	-



100%Chef



Nitro Bowl; szkło borosilikatowe
Nitro Bowl; borosilicate glass

Nr kat.	Ø cm	cap l	PLN	EUR
C1-1218	13	0,5	264,34	-



100%Chef



Kieliszek do serwowania; szkło borosilikatowe
Serving glass; borosilicate glass

Nr kat.	Ø cm	h cm	cap ml	PLN	EUR
C1-1610	7,5	23	350	165,49	-

Śr. wew. - 7,5 cm; śr.zew. - 10 cm
Inner diameter - 7,5 cm; outer diameter - 10 cm



100%Chef



Kieliszek do serwowania; szkło borosilikatowe
Serving glass; borosilicate glass

Nr kat.	Ø cm	l cm	cap ml	PLN	EUR
C1-1617	8	22	350	198,20	-

Śr. wew. - 8 cm; śr.zew. - 12 cm
Inner diameter - 8 cm; outer diameter - 12 cm



100%Chef



Talerz Owini; szkło borosilikatowe
Owini plate; borosilicate glass

Nr kat.	Ø cm	PLN	EUR
C1-1606	28	423,44	-

Talerz idealnie nadaje się do prezentowania potraw kuchni molekularnej w towarzystwie suchego lodu, dymu aromatyzera itp.
The plate is ideally suited for presenting molecular cuisine dishes accompanied by dry ice, aroma of the aromatizer, etc.

KUP ON-LINE



Verlo

Verlo, to marka oferująca poza asortymentem bufetowym i cateringowym, wysokiej jakości sztucce wykonane ze stopu stali chromowo-niklowej 18/10. Design kolekcji to nowoczesna klasyka, uniwersalna dla każdej aranżacji wnętrza. Wszystkie sztucce są doskonale wyważone i wygodne w użyciu.

Verlo is a brand offering, apart from the buffet and catering assortment, high-quality cutlery made of 18/10 chrome-nickel alloy steel. Verlo lines are classic, yet modern. All the pieces of cutlery are perfectly balanced and comfortable to use.

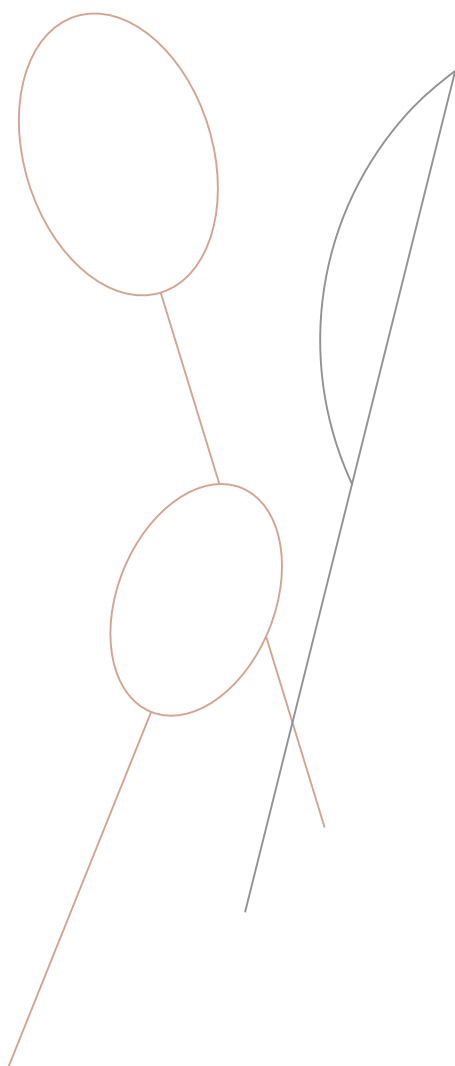

Istnieje możliwość personalizacji
You can personalize these products

Idealne

Linie sztućców Verlo zwracają uwagę ponadczasowym wzornictwem i pięknym połyskiem, który osiągany jest dzięki procesowi kilkukrotnego polerowania.

Ideal: *Verlo lines draw attention with its timeless design and a beautiful gloss, obtained during the polishing process which is repeated several times.*

design

Elegancki i stylowy design sztućców będzie idealnym uzupełnieniem nowoczesnej porcelany i zastawy stołowej.

Its elegant and stylish design will be a perfect complement to modern porcelain and tableware.

Dzięki najwyższej jakości stali są odporne na działanie korozji oraz nadają się do mycia w zmywarce. (nie dotyczy LUI GOLD, DESTELLO COPPER, SU BLACK)

Made of the highest quality steel, the cutlery is corrosion resistant and suitable for washing in a dishwasher. (excluding LUI GOLD, DESTELLO COPPER, SU BLACK)

KUP ON-LINE





LUI GOLD



DESTELLO COPPER



SU ANTIQUE



SU BLACK



ELGADO



AGILA



LUI



DESTELLO



SU



TRES

KUP ON-LINE 



Widelec stołowy - złoty
Table fork - gold

V-5000-1G-12

l: 204 mm
thk: 5 mm

PLN / EUR: 16,74 / -



Łyżka stołowa - złota
Table spoon - gold

V-5000-2G-12

l: 203 mm
thk: 5 mm

PLN / EUR: 16,74 / -



Nóż stołowy - złoty
Table knife - gold

V-5000-5G-12

l: 235 mm
wgt: 80 g

PLN / EUR: 16,74 / -



Widelec przystawkowy - złoty
Dessert fork - gold

V-5000-14G-12

l: 185 mm
thk: 4,5 mm

PLN / EUR: 15,63 / -



Łyżeczka do herbaty - złota
Tea spoon - gold

V-5000-3G-12

l: 135 mm
thk: 4 mm

PLN / EUR: 12,28 / -



Łyżeczka do espresso - złota
Espresso spoon - gold

V-5000-26G-12

l: 118 mm
thk: 3 mm

PLN / EUR: 11,94 / -



Łyżka do latte - złota
Latte spoon - gold

V-5000-25G-12

l: 205 mm
thk: 4,5 mm

PLN / EUR: 14,51 / -





Widelec stołowy - miedziany
Table fork - copper

V-6000-1C-12

l: 210 mm
thk: 4 mm

PLN/EUR: 17,97 / -



Łyżka stołowa - miedziana
Table spoon - copper

V-6000-2C-12

l: 210 mm
thk: 4 mm

PLN/EUR: 17,86 / -



Nóż stołowy - miedziany
Table knife - copper

V-6000-5C-12

l: 238 mm
wgt: 130 g

PLN/EUR: 17,97 / -



Widelec przystawkowy - miedziany
Dessert fork - copper

V-6000-14C-12

l: 185 mm
thk: 3,5 mm

PLN/EUR: 15,52 / -



Nóż przystawkowy
Dessert knife

V-6000-6C-12

l: 214 mm
wgt: 90 g

PLN/EUR: 17,97 / -



Łyżeczka do herbaty - miedziana
Tea spoon - copper

V-6000-3C-12

l: 145 mm
thk: 3,5 mm

PLN/EUR: 12,06 / -



Łyżeczka do espresso
Espresso spoon

V-6000-26C-12

l: 118 mm
thk: 3,5 mm

PLN/EUR: 12,06 / -



Łyżka do latte
Latte spoon

V-6000-25C-12

l: 190 mm
thk: 3,5 mm

PLN/EUR: 18,48 / -



Nóż do masła
Butter knife

V-6000-27BC-12

l: 160 mm
wgt: 60 g

PLN/EUR: 17,56 / -





Widelc stołowy - postarzany
Table fork - antique

V-7000-1A-12

l: 204 mm
thk: 4 mm

PLN/EUR: 12,28 / -



łyżka stołowa - postarzana
Table spoon - antique

V-7000-2A-12

l: 204 mm
thk: 4 mm

PLN/EUR: 12,28 / -



Nóż stołowy - postarzany
Table knife - antique

V-7000-5A-12

l: 225 mm
wgt: 80 g

PLN/EUR: 13,83 / -



Widelc przystawkowy - postarzany
Dessert fork - antique

V-7000-14A-12

l: 184 mm
thk: 3,5 mm

PLN/EUR: 11,16 / -



Nóż przystawkowy
Dessert knife

V-7000-6A-12

l: 210 mm
wgt: 70 g

PLN/EUR: 13,07 / -



łyżeczka do herbaty - postarzana
Tea spoon - antique

V-7000-3A-12

l: 144 mm
thk: 3,5 mm

PLN/EUR: 8,26 / -



łyżeczka do espresso
Espresso spoon

V-7000-26A-12

l: 108 mm
thk: 3,5 mm

PLN/EUR: 7,26 / -



łyżka do latte
Latte spoon

V-7000-25A-12

l: 196 mm
thk: 3,5 mm

PLN/EUR: 11,00 / -



Widelczyk do ciasta
Cake fork

V-7000-4A-12

l: 155 mm
thk: 3,5 mm

PLN/EUR: 8,14 / -



Nóż do masła
Butter knife

V-7000-27BA-12

l: 176 mm
wgt: 60 g

PLN/EUR: 13,07 / -





Widelec stołowy - czarny
Table fork - black

V-7000-1B-12

l: 204 mm
thk: 4 mm

PLN / EUR: 17,41 / -



Łyżka stołowa - czarna
Table spoon - black

V-7000-2B-12

l: 204 mm
thk: 4 mm

PLN / EUR: 17,41 / -



Nóż stołowy - czarny
Table knife - black

V-7000-5B-12

l: 225 mm
wgt: 80 g

PLN / EUR: 18,64 / -



Widelec przystawkowy - czarny
Dessert fork - black

V-7000-14B-12

l: 184 mm
thk: 3,5 mm

PLN / EUR: 16,30 / -



Nóż do steków - czarny
Steak knife - black

V-7000-45B-12

l: 225 mm
wgt: 80 g

PLN / EUR: 17,19 / -



Łyżeczka do herbaty - czarna
Tea spoon - black

V-7000-3B-12

l: 144 mm
thk: 3,5 mm

PLN / EUR: 15,52 / -



Łyżeczka do espresso - czarna
Espresso spoon - black

V-7000-26B-12

l: 108 mm
thk: 3,5 mm

PLN / EUR: 12,50 / -



Łyżka do latte - czarna
Latte spoon - black

V-7000-25B-12

l: 196 mm
thk: 3,5 mm

PLN / EUR: 16,86 / -





Widelec stołowy; 18/10
Table fork; 18/10

V-4100-1-12

l: 201 mm
thk: 2,5 mm

PLN / EUR: 7,59 / -



Łyżka stołowa; 18/10
Table spoon; 18/10

V-4100-2-12

l: 197 mm
thk: 2,5 mm

PLN / EUR: 7,59 / -



Nóż stołowy; 18/10
Table knife; 18/10

V-4100-5-12

l: 233 mm

PLN / EUR: 7,93 / -



Łyzeczka do herbaty; 18/10
Tea spoon; 18/10

V-4100-3-12

l: 143 mm
thk: 2 mm

PLN / EUR: 4,69 / -



Łyzeczka do espresso; 18/10
Espresso spoon; 18/10

V-4100-26-12

l: 112 mm
thk: 2 mm

PLN / EUR: 3,91 / -



Łyżka do latte; 18/10
Latte spoon; 18/10

V-4100-25-12

l: 170 mm
thk: 2 mm

PLN / EUR: 5,36 / -



Widelczyk do ciasta; 18/10
Cake fork; 18/10

V-4100-4-12

l: 143 mm
thk: 2 mm

PLN / EUR: 4,69 / -



AGILA 18/10



Widelec stołowy; 18/10
Table fork; 18/10

V-7100-1-12

l: 218 mm
thk: 5,5 mm

PLN/EUR: 13,62 / -



Łyżka stołowa; 18/10
Table spoon; 18/10

V-7100-2-12

l: 218 mm
thk: 5,5 mm

PLN/EUR: 13,62 / -



Nóż stołowy; 18/10
Table knife; 18/10

V-7100-5-12

l: 244 mm

PLN/EUR: 11,16 / -



Widelec przystawkowy; 18/10
Dessert fork; 18/10

V-7100-14-12

l: 190 mm
thk: 4,5 mm

PLN/EUR: 9,60 / -



Łyżka przystawkowa; 18/10
Dessert spoon; 18/10

V-7100-15-12

l: 192 mm
thk: 4,5 mm

PLN/EUR: 9,60 / -



Nóż przystawkowy; 18/10
Dessert knife; 18/10

V-7100-6-12

l: 220 mm

PLN/EUR: 9,60 / -



Łyżeczka do herbaty; 18/10
Tea spoon; 18/10

V-7100-3-12

l: 146 mm
thk: 3,5 mm

PLN/EUR: 6,92 / -



Łyżeczka do espresso; 18/10
Espresso spoon; 18/10

V-7100-26-12

l: 114 mm
thk: 2,5 mm

PLN/EUR: 5,58 / -



Łyżka do latte; 18/10
Latte spoon; 18/10

V-7100-25-12

l: 211 mm
thk: 3,5 mm

PLN/EUR: 9,04 / -



Widelczyk do ciasta; 18/10
Cake fork; 18/10

V-7100-4-12

l: 148 mm
thk: 3,5 mm

PLN/EUR: 6,92 / -



Nóż do masła; 18/10
Butter knife; 18/10

V-7100-27B-12

l: 175 mm

PLN/EUR: 8,60 / -



Nóż do steków; 18/10
Steak knife; 18/10

V-7100-45-12

l: 244 mm

PLN/EUR: 11,16 / -

KUP ON-LINE 



Widelc stołowy
Table fork

V-5000-1-12

l: 204 mm
thk: 5 mm

PLN/EUR: 11,27 / -



Łyżka stołowa
Table spoon

V-5000-2-12

l: 203 mm
thk: 5 mm

PLN/EUR: 11,27 / -



Nóż stołowy
Table knife

V-5000-5-12

l: 235 mm
thk: 8 mm

PLN/EUR: 11,27 / -



Widelc przystawkowy
Dessert fork

V-5000-14-12

l: 185 mm
thk: 4,5 mm

PLN/EUR: 10,16 / -



Łyżka przystawkowa
Dessert spoon

V-5000-15-12

l: 181 mm
thk: 4,5 mm

PLN/EUR: 10,16 / -



Nóż przystawkowy
Dessert knife

V-5000-6-12

l: 213 mm
thk: 8 mm

PLN/EUR: 10,16 / -



Widelczyk do ciasta
Cake fork

V-5000-4-12

l: 144 mm
thk: 4 mm

PLN/EUR: 6,81 / -



Łyzeczka do herbaty
Table spoon

V-5000-3-12

l: 135 mm
thk: 4 mm

PLN/EUR: 6,81 / -



Łyzeczka do espresso
Espresso spoon

V-5000-26-12

l: 118 mm
thk: 3 mm

PLN/EUR: 6,47 / -



Łyżka do latte
Latte spoon

V-5000-25-12

l: 205 mm
thk: 4,5 mm

PLN/EUR: 9,04 / -



Nóż do steków
Steak knife

V-5000-45-12

l: 235 mm
thk: 8 mm

PLN/EUR: 11,27 / -



Nóż do masła
Butter knife

V-5000-27B-12

l: 161 mm
thk: 6 mm

PLN/EUR: 9,60 / -



Łyżka do serwowania
Serving spoon

V-5000-12-12

l: 231 mm
thk: 4,5 mm

PLN/EUR: 26,33 / -



Widelc do serwowania
Serving fork

V-5000-21-12

l: 233 mm
thk: 4,5 mm

PLN/EUR: 22,39 / -



Widelec stołowy
Table Fork

V-6000-1-12

l: 210 mm
thk: 4 mm

PLN / EUR: 12,30 / -

Łyżka stołowa
Table spoon

V-6000-2-12

l: 210 mm
thk: 4 mm

PLN / EUR: 12,30 / -



Nóż stołowy
Table knife

V-6000-5-12

l: 238 mm
wgt: 130 g

PLN / EUR: 12,41 / -

Widelc przystawkowy
Dessert fork

V-6000-14-12

l: 188 mm
thk: 3,5 mm

PLN / EUR: 9,71 / -



Łyżka przystawkowa
Dessert spoon

V-6000-15-12

l: 188 mm
thk: 3,5 mm

PLN / EUR: 9,71 / -

Nóż przystawkowy
Dessert knife

V-6000-6-12

l: 214 mm
wgt: 90 g

PLN / EUR: 10,84 / -



Łyżeczka do herbaty
Tea spoon

V-6000-3-12

l: 145 mm

PLN / EUR: 6,25 / -

Łyżeczka do espresso
Espresso spoon

V-6000-26-12

l: 118 mm
thk: 3,5 mm

PLN / EUR: 5,02 / -



Łyżka do latte
Latte spoon

V-6000-25-12

l: 190 mm
thk: 3,5 mm

PLN / EUR: 8,82 / -

Widelczyk do ciasta
Cake fork

V-6000-4-12

l: 146 mm
thk: 3,5 mm

PLN / EUR: 6,25 / -



Nóż do masła
Butter knife

V-6000-27B-12

l: 160 mm
wgt: 60 g

PLN / EUR: 8,71 / -

Nóż do steków
Steak knife

V-6000-45-12

l: 238 mm
wgt: 130 g

PLN / EUR: 12,97 / -



Widelc stołowy
Table fork

V-7000-1-12

l: 204 mm
thk: 4 mm

PLN / EUR: 10,28 / -

Łyżka stołowa
Table spoon

V-7000-2-12

l: 204 mm
thk: 4 mm

PLN / EUR: 10,28 / -

Nóż stołowy
Table knife

V-7000-5-12

l: 225 mm
wgt: 80 g

PLN / EUR: 13,08 / -

Widelc przystawkowy
Dessert fork

V-7000-14-12

l: 184 mm
thk: 3,5 mm

PLN / EUR: 9,39 / -



Łyżka przystawkowa
Dessert spoon

V-7000-15-12

l: 183 mm
thk: 3,5 mm

PLN / EUR: 9,39 / -



Nóż przystawkowy
Dessert knife

V-7000-6-12

l: 210 mm
wgt: 70 g

PLN / EUR: 9,51 / -



Łyzeczka do herbaty
Tea spoon

V-7000-3-12

l: 144 mm
thk: 3,5 mm

PLN / EUR: 6,14 / -



Łyzeczka do espresso
Espresso spoon

V-7000-26-12

l: 108 mm
thk: 3,5 mm

PLN / EUR: 5,48 / -



Łyżka do latte
Latte spoon

V-7000-25-12

l: 196 mm
thk: 3,5 mm

PLN / EUR: 12,26 / -



Widelczyk do ciasta
Cake fork

V-7000-4-12

l: 155 mm
thk: 3,5 mm

PLN / EUR: 6,14 / -



Nóż do masła
Butter knife

V-7000-27B-12

l: 176 mm
wgt: 60 g

PLN / EUR: 10,00 / -



Nóż do steków
Steak knife

V-7000-45-12

l: 225 mm
wgt: 80 g

PLN / EUR: 12,26 / -





Widelec stołowy
Table fork

V-4000-1-12

l: 203 mm
thk: 3,5 mm

PLN/EUR: 8,93 / -

Łyżka stołowa
Table spoon

V-4000-2-12

l: 205 mm
thk: 3,5 mm

PLN/EUR: 8,93 / -

Nóż stołowy
Table knife

V-4000-5-12

l: 235 mm
thk: 3,5 mm

PLN/EUR: 10,27 / -

Wideliec przystawkowy
Dessert fork

V-4000-14-12

l: 180 mm
thk: 3,5 mm

PLN/EUR: 7,70 / -



Łyżka przystawkowa
Dessert spoon

V-4000-15-12

l: 173 mm
thk: 3,5 mm

PLN/EUR: 7,70 / -



Nóż przystawkowy
Dessert knife

V-4000-6-12

l: 206 mm
thk: 3,5 mm

PLN/EUR: 8,93 / -



Widelczyk do ciasta
Cake fork

V-4000-4-12

l: 141 mm
thk: 3,5 mm

PLN/EUR: 5,02 / -



Łyżeczka do herbaty
Tea spoon

V-4000-3-12

l: 137 mm
thk: 3,5 mm

PLN/EUR: 5,02 / -



Łyżeczka do espresso
Espresso spoon

V-4000-26-12

l: 114 mm
thk: 3,5 mm

PLN/EUR: 4,80 / -



Łyżka do latte
Latte spoon

V-4000-25-12

l: 203 mm
thk: 3,5 mm

PLN/EUR: 7,26 / -



Eternum to połączenie designu, estetyki i najwyższej jakości materiału wraz z precyzją wykonania. Od 1924 roku firma produkuje wspaniałe kolekcje sztućców, zarówno dla prestiżowych hoteli i restauracji jak i lokali potrzebujących bardziej ekonomicznych rozwiązań.

Eternum is a combination of design, aesthetics, top quality material with the precision of workmanship. Since 1924, the company has been producing great cutlery collections for both prestigious hotels and restaurants as well as premises that need more cost-effective solutions.

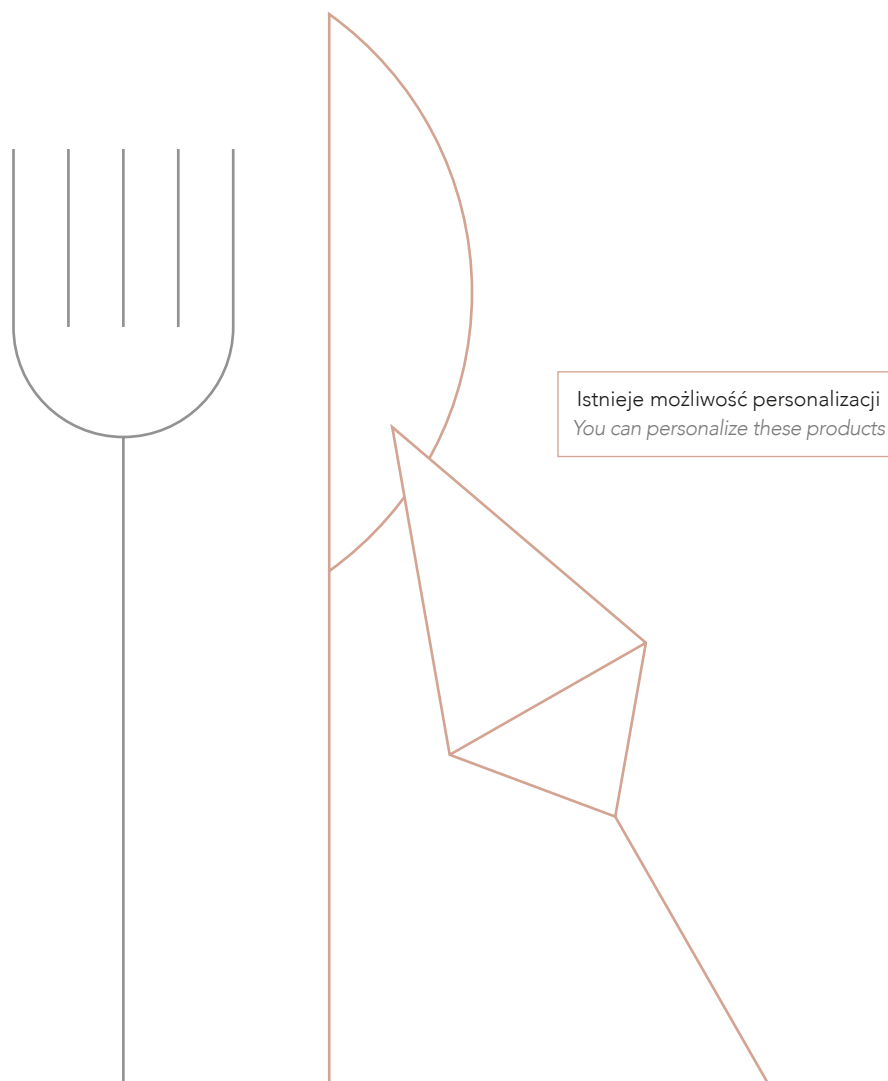

KUP ON-LINE



personalizacja

Marka dodatkowo oferuje możliwość personalizacji, postarzenia lub pokrycia powłoką PVD każdego kompletu. O szczegóły zapytaj sprzedawcę.

personalization: *There is an option to personalize each set. Additionally cutlery can be aged or PVD coated. Ask the seller for details.*

Wyspecjalizowane podejście i polityka intensywnego rozwoju produktu, sprawiła, że marka Eternum jest najbardziej znaczącym dostawcą sztućców na świecie.

The specialized approach and the policy of intensive product development has made the Eternum brand the most significant cutlery supplier in the world.

Sztućce Eternum sprzedawane są w kompletach po 12 sztuk.

The Eternum cutlery are sold in sets of 12 pieces.



X15 18/10



ADAGIO 18/10



BYBLOS 18/10



ANZO 18/10



X-LO 18/10



CURVE 18/10



ARCADE 18/10



ALASKA 18/10



ATLANTIS 18/10



ANSER 18/10



BAGUETTE LM 18/10



SONATE 18/10



OPERA 18/0



RIVOLI 18/10



AUDE 18/0

KUP ON-LINE 



Widelec stołowy
Table fork

E-1860-1-12

l: 218 mm
thk: 10 mm

PLN / EUR: 40,95 / -



Łyżka stołowa
Table spoon

E-1860-2-12

l: 219 mm
thk: 10 mm

PLN / EUR: 40,95 / -



Nóż stołowy
Table knife

E-1860-5-12

l: 243 mm
wgt: 140 g

PLN / EUR: 24,15 / -



Widelec przystawkowy
Dessert fork

E-1860-14-12

l: 193 mm
thk: 8,8 mm

PLN / EUR: 33,75 / -



Łyżka przystawkowa
Dessert spoon

E-1860-15-12

l: 193 mm
thk: 8,8 mm

PLN / EUR: 33,75 / -



Nóż przystawkowy
Dessert knife

E-1860-6-12

l: 217 mm
wgt: 93 g

PLN / EUR: 25,07 / -



Widelczyk do ciasta
Cake fork

E-1860-4-12

l: 145 mm
thk: 7,2 mm

PLN / EUR: 21,70 / -



Łyzeczka do herbaty
Tea spoon

E-1860-3-12

l: 146 mm
thk: 7,2 mm

PLN / EUR: 21,70 / -



Łyzeczka do espresso
Espresso spoon

E-1860-26-12

l: 110 mm
thk: 5,5 mm

PLN / EUR: 17,65 / -



Łyżka do latte
Latte spoon

E-1860-25-12

l: 215 mm
thk: 9,5 mm

PLN / EUR: 34,80 / -



Widelec do ryby
Fish fork

E-1860-16-12

l: 192 mm
thk: 8,5 mm

PLN / EUR: 33,75 / -



Nóż do ryb
Fish knife

E-1860-17-12

l: 207 mm
thk: 8,5 mm

PLN / EUR: 35,80 / -

X15 18/10



Nóż do steków
Steak knife

E-1860-45-12

l: 243 mm

wgt: 137 g

PLN/EUR: 26,60 / -



Łyżka do bulionu
Broth spoon

E-1860-33-12

l: 190 mm

thk: 8,8 mm

PLN/EUR: 35,80 / -



Nóż do masła
Butter knife

E-1860-40-12

l: 162 mm

wgt: 46 g

PLN/EUR: 17,30 / -



Zestaw do sałaty
Salad set; 18/10

E-1860-10-1

l: 300 mm

PLN/EUR: 216,63 / -

ADAGIO 18/10



Widelec stołowy
Table fork

E-2090-1-12

l: 205 mm

thk: 4 mm

PLN/EUR: 26,37 / -



Łyżka stołowa
Table spoon

E-2090-2-12

l: 206 mm

thk: 4 mm

PLN/EUR: 26,37 / -



Nóż stołowy
Table knife

E-2090-5-12

l: 224 mm

wgt: 87 g

PLN/EUR: 30,62 / -



Widelec przystawkowy
Dessert fork

E-2090-14-12

l: 184 mm

thk: 3 mm

PLN/EUR: 20,67 / -

KUP ON-LINE





Łyżka przystawkowa
Dessert spoon

E-2090-15-12

l: 181 mm
thk: 3 mm

PLN / EUR: 20,67 / -



Nóż przystawkowy
Dessert knife

E-2090-6-12

l: 203 mm
wgt: 60 g

PLN / EUR: 21,88 / -



Widelczyk do ciasta
Cake fork

E-2090-4-12

l: 140 mm
thk: 2,5 mm

PLN / EUR: 12,70 / -



Łyzeczka do herbaty
Tea spoon

E-2090-3-12

l: 139 mm
thk: 2,5 mm

PLN / EUR: 12,22 / -



Łyzeczka do espresso
Espresso spoon

E-2090-26-12

l: 117 mm
thk: 2,5 mm

PLN / EUR: 10,63 / -



Widelec do ryby
Fish fork

E-2090-16-12

l: 189 mm
thk: 3 mm

PLN / EUR: 21,69 / -



Nóż do ryb
Fish knife

E-2090-17-12

l: 204 mm
thk: 3 mm

PLN / EUR: 21,69 / -



Łyżka do serwowania
Serving spoon

E-2090-12-1

l: 251 mm
thk: 4 mm

PLN / EUR: 84,81 / -



Nóż do masła
Butter knife

E-2090-40-12

l: 163 mm
wgt: 40 g

PLN / EUR: 25,07 / -





Widelec stołowy
Table fork

E-1840-1-12
l: 209 mm
thk: 3,5 mm
PLN / EUR: 25,50 / -



Łyżka stołowa
Table spoon

E-1840-2-12
l: 206 mm
thk: 3,7 mm
PLN / EUR: 25,50 / -



Nóż stołowy
Table knife

E-1840-5-12
l: 239 mm
wgt: 144 g
PLN / EUR: 26,72 / -



Widelc przystawkowy
Dessert fork

E-1840-14-12
l: 183 mm
thk: 3,2 mm
PLN / EUR: 18,53 / -



Łyżka przystawkowa
Dessert spoon

E-1840-15-12
l: 181 mm
thk: 3,2 mm
PLN / EUR: 18,53 / -



Nóż przystawkowy
Dessert knife

E-1840-6-12
l: 216 mm
wgt: 95 g
PLN / EUR: 16,95 / -



Widelczyk do ciasta
Cake fork

E-1840-4-12
l: 147 mm
thk: 2,6 mm
PLN / EUR: 26,87 / -



Łyżeczka do herbaty
Tea spoon

E-1840-3-12
l: 143 mm
thk: 2,8 mm
PLN / EUR: 12,03 / -



Łyżeczka do espresso
Espresso spoon

E-1840-26-12
l: 116 mm
thk: 2,6 mm
PLN / EUR: 10,67 / -



Łyżka do latte
Latte spoon

E-1840-25-12
l: 193 mm
thk: 3,2 mm
PLN / EUR: 30,29 / -



Widelc do ryby
Fish fork

E-1840-16-12
l: 178 mm
thk: 3,2 mm
PLN / EUR: 22,57 / -



Nóż do ryb
Fish knife

E-1840-17-12
l: 197 mm
thk: 3,2 mm
PLN / EUR: 22,57 / -



Łyżka do bulionu
Broth spoon

E-1840-33-12
l: 172 mm
thk: 3,2 mm
PLN / EUR: 31,35 / -



Nóż do masła
Butter knife

E-1840-40-12
l: 162 mm
wgt: 41 g
PLN / EUR: 14,96 / -





Widelec stołowy
Table fork

E-1820-1-12

l: 212 mm
thk: 4,1 mm

PLN / EUR: 18,06 / -



Łyżka stołowa
Table spoon

E-1820-2-12

l: 214 mm
thk: 4,1 mm

PLN / EUR: 18,06 / -



Nóż stołowy
Table knife

E-1820-5-12

l: 235 mm
wgt: 115 g

PLN / EUR: 23,33 / -



Nóż stołowy
Table knife

E-1820-5E-12

l: 235 mm
wgt: 121 g

PLN / EUR: 25,21 / -



Widelec przystawkowy
Dessert fork

E-1820-14-12

l: 192 mm
thk: 3,1 mm

PLN / EUR: 16,23 / -



Łyżka przystawkowa
Dessert spoon

E-1820-15-12

l: 192 mm
thk: 3,1 mm

PLN / EUR: 16,23 / -



Nóż przystawkowy
Dessert knife

E-1820-6-12

l: 215 mm
wgt: 86 g

PLN / EUR: 21,01 / -



Nóż przystawkowy
Dessert knife

E-1820-6E-12

l: 215 mm
wgt: 88 g

PLN / EUR: 22,75 / -



Widelczyk do ciasta
Cake fork

E-1820-4-12

l: 147 mm
thk: 2,6 mm

PLN / EUR: 9,47 / -



Łyżeczka do herbaty
Tea spoon

E-1820-3-12

l: 147 mm
thk: 2,6 mm

PLN / EUR: 9,23 / -



Łyżeczka do espresso
Espresso spoon

E-1820-26-12

l: 110 mm
thk: 2,2 mm

PLN / EUR: 8,50 / -



Łyżka do latte
Latte spoon

E-1820-25-12

l: 210 mm
thk: 3,1 mm

PLN / EUR: 13,62 / -

ANZO 18/10



Widelec do ryby
Fish fork

E-1820-16-12

l: 192 mm
thk: 3,1 mm

PLN/EUR: 17,15 / -



Nóż do ryb
Fish knife

E-1820-17-12

l: 217 mm
thk: 3,1 mm

PLN/EUR: 17,15 / -



Łyżka do bulionu
Broth spoon

E-1820-33-12

l: 184 mm
thk: 3,1 mm

PLN/EUR: 17,15 / -



Nóż do masła
Butter knife

E-1820-40-12

l: 160 mm
wgt: 38 g

PLN/EUR: 16,81 / -

X-LO 18/10



Widelec stołowy
Table fork

E-3090-1-12

l: 220 mm
thk: 3,5 mm

PLN/EUR: 14,78 / -



Łyżka stołowa
Table spoon

E-3090-2-12

l: 220 mm
thk: 3,5 mm

PLN/EUR: 14,78 / -



Nóż stołowy
Table knife

E-3090-5-12

l: 243 mm
wgt: 80 g

PLN/EUR: 12,39 / -



Widelec przystawkowy
Dessert fork

E-3090-14-12

l: 193 mm
thk: 3 mm

PLN/EUR: 11,54 / -

X-LO 18/10

Łyżka przystawkowa
Dessert spoon

E-3090-15-12

l: 193 mm
thk: 3 mm

PLN / EUR: 11,54 / -

Nóż przystawkowy
Dessert knife

E-3090-6-12

l: 219 mm
wgt: 58 g

PLN / €: 12,82 / -

Widelczyk do ciasta
Cake fork

E-3090-4-12

l: 141 mm
thk: 2,5 mm

PLN / EUR: 8,84 / -

Łyżeczka do herbaty
Tea spoon

E-3090-3-12

l: 144 mm
thk: 2,5 mm

PLN / EUR: 7,97 / -

Łyżeczka do espresso
Espresso spoon

E-3090-26-12

l: 110 mm
thk: 2,5 mm

PLN / EUR: 6,67 / -

Łyżka do latte
Latte spoon

E-2080-25-12

l: 200 mm
thk: 3,2 mm

PLN / EUR: 24,68 / -

Widelec do ryb
Fish fork

E-3090-16-12

l: 182 mm
thk: 3 mm

PLN / EUR: 12,08 / -

Nóż do ryb
Fish knife

E-3090-17-12

l: 208 mm
thk: 3 mm

PLN / EUR: 12,08 / -

Nóż do steków
Steak knife

E-3090-45-12

l: 248 mm
wgt: 80 g

PLN / EUR: 17,48 / -

Łyżka do bulionu
Broth spoon

E-3090-33-12

l: 182 mm
thk: 3 mm

PLN / EUR: 12,41 / -

Nóż do masła
Butter knife

E-3090-40-12

l: 165 mm
wgt: 34 g

PLN / €: 12,36 / -

Łyżka do serwowania
Serving spoon

E-2080-12-1

l: 251 mm
thk: 3,5 mm

PLN / EUR: 63,94 / -

Widelec do spaghetti
Spaghetti fork

E-2080-35-12

l: 220 mm
thk: 3,5 mm

PLN / EUR: 15,12 / -

Łyżka do spaghetti; 18/10
Spaghetti spoon; 18/10

E-2080-36-12

l: 213 mm
thk: 3,5 mm

PLN / EUR: 15,12 / -

Łyżka do sosów; 18/10
Sauce spoon

E-2080-11-1

l: 171 mm
thk: 3,5 mm

PLN / EUR: 90,34 / -

Chochelka do zupy
Ladle

E-2080-7-1

l: 165 mm
thk: 3,5 mm

PLN / EUR: 90,34 / -

Zestaw do sałaty
Salad set; 18/10

E-2080-10-1

l: 238 mm
thk: 3,5 mm

PLN / EUR: 90,34 / -

Łopatka do tortu
Cake server

E-2080-8-1

l: 259 mm
thk: 3,5 mm

PLN / EUR: 89,64 / -



CURVE 18/10



Widelec stołowy
Table fork

E-964-1-12
l: 210 mm
thk: 2,5 mm
PLN / EUR: 13,57 / -



Łyżka stołowa
Table spoon

E-964-2-12
l: 210 mm
thk: 2,5 mm
PLN / EUR: 13,57 / -



Nóż stołowy
Table knife

E-964-5-12
l: 225 mm
wgt: 85 g
PLN / EUR: 14,20 / -



Wideliec przystawkowy
Dessert fork

E-964-14-12
l: 190 mm
thk: 2,5 mm
PLN / EUR: 11,59 / -



Łyżka przystawkowa
Dessert spoon

E-964-15-12
l: 190 mm
thk: 2,5 mm
PLN / EUR: 11,59 / -



Nóż przystawkowy
Dessert knife

E-964-6-12
l: 205 mm
wgt: 62 g
PLN / EUR: 12,85 / -



Widelczyk do ciasta
Cake fork

E-964-4-12
l: 140 mm
thk: 2 mm
PLN / EUR: 6,62 / -



Łyżka do herbaty
Tea spoon

E-964-3-12
l: 140 mm
thk: 2 mm
PLN / EUR: 6,33 / -



Łyzeczka do espresso
Espresso spoon

E-964-26-12
l: 110 mm
thk: 1,8 mm
PLN / EUR: 5,84 / -



Łyżka do latte
Latte spoon

E-3010-25-12
l: 208 mm
thk: 2,8 mm
PLN / EUR: 19,48 / -



Widelec do ryb
Fish fork

E-964-16-12
l: 183 mm
thk: 2,5 mm
PLN / EUR: 11,98 / -



Nóż do ryb
Fish knife

E-964-17-12
l: 198 mm
thk: 2,5 mm
PLN / EUR: 11,98 / -



Nóż do masła
Butter knife

E-3010-40-12
l: 165 mm
wgt: 39 g
PLN / EUR: 18,02 / -

CURVE 18/10



Łyżka do sosów; 18/10
Sauce spoon

E-964-11-1

l: 169 mm
thk: 1,8 mm

PLN / EUR: 68,83 / -



Łyżka do serwowania
Serving spoon

E-964-12-1

l: 245 mm
thk: 3 mm

PLN / EUR: 48,06 / -



Zestaw do sałaty
Salad set; 18/10

E-964-10-1

l: 231 mm
thk: 3 mm

PLN / EUR: 81,14 / -

ARCADE 18/10



Widelec stołowy
Table fork

E-1620-1-12

l: 208 mm
thk: 3,5 mm

PLN / EUR: 12,47 / -



Łyżka stołowa
Table spoon

E-1620-2-12

l: 208 mm
thk: 3,5 mm

PLN / EUR: 12,47 / -



Nóż stołowy
Table knife

E-1620-5-12

l: 238 mm
wgt: 106 g

PLN / EUR: 15,02 / -



Nóż stołowy, osadzony
Table knife, hollow handle

E-1620-51-12

l: 238 mm
wgt: 106 g

PLN / EUR: 42,84 / -

ARCADE 18/10



Widelec przystawkowy
Dessert fork

E-1620-14-12

l: 187 mm
thk: 2,8 mm

PLN / EUR: 10,08 / -



Łyżka przystawkowa
Dessert spoon

E-1620-15-12

l: 185 mm
thk: 2,8 mm

PLN / EUR: 10,08 / -



Nóż przystawkowy
Dessert knife

E-1620-6-12

l: 216 mm
wgt: 79 g

PLN / EUR: 12,13 / -



Nóż przystawkowy
Dessert knife

E-3050-6-12

l: 210 mm
wgt: 77 g

PLN / EUR: 14,05 / -



Nóż przystawkowy, osadzony
Dessert knife, hollow handle

E-1620-61-12

l: 215 mm

PLN / EUR: 42,31 / -



Widelczyk do ciasta
Cake fork

E-1620-4-12

l: 144 mm
thk: 2,5 mm

PLN / EUR: 5,87 / -



Łyżeczka do herbaty
Tea spoon

E-1620-3-12

l: 143 mm
thk: 2,5 mm

PLN / EUR: 6,26 / -



Łyżeczka do espresso
Espresso spoon

E-1620-26-12

l: 117 mm
thk: 2,2 mm

PLN / EUR: 5,80 / -



Łyżka do latte
Latte spoon

E-1922-25-12

l: 197 mm
thk: 2 mm

PLN / EUR: 6,18 / -



Widelec do ryb
Fish fork

E-1620-16-12

l: 181 mm
thk: 2,8 mm

PLN / EUR: 10,08 / -



Nóż do ryb
Fish knife

E-1620-17-12

l: 201 mm
thk: 2,8 mm

PLN / EUR: 10,66 / -



Nóż do steków
Steak knife

E-1620-45-12

l: 238 mm
wgt: 106 g

PLN / EUR: 15,97 / -



Nóż do masła
Butter knife

E-1620-40-12

l: 161 mm
wgt: 42 g

PLN / EUR: 10,29 / -



Nóż do masła
Butter knife

E-3050-40-12

l: 158 mm
wgt: 38 g

PLN / EUR: 13,04 / -



Łyżka do bulionu
Broth spoon

E-1620-33-12

l: 173 mm
thk: 2,8 mm

PLN / EUR: 13,53 / -



Łyżka do sosów; 18/10
Sauce spoon; 18/10

E-3050-11-1

l: 169 mm
thk: 2,5 mm

PLN / EUR: 52,90 / -



Chochelka do zupy
Ladle

E-3050-7-1

l: 302 mm
thk: 3 mm

PLN / EUR: 82,16 / -



Łyżka do serwowania
Serving spoon

E-3050-12-1

l: 247 mm
thk: 3 mm

PLN / EUR: 35,24 / -



Zestaw do sałaty
Salad set; 18/10

E-3050-10-1

l: 286 mm
thk: 3 mm

PLN / EUR: 94,39 / -



Łopatka do tortu
Cake server

E-3050-8-1

l: 231 mm
thk: 2,5 mm

PLN / EUR: 50,06 / -





Widelec stołowy
Table fork

E-2080-1-12

l: 203 mm
thk: 3,5 mm

PLN / EUR: 12,12 / -

Łyżka stołowa
Table spoon

E-2080-2-12

l: 205 mm
thk: 3,5 mm

PLN / EUR: 12,12 / -

Nóż stołowy
Table knife

E-2080-5-12

l: 226 mm
wgt: 68 g

PLN / EUR: 12,04 / -

Widelec przystawkowy
Dessert fork

E-2080-14-12

l: 181 mm
thk: 3 mm

PLN / EUR: 10,58 / -



Łyżka przystawkowa
Dessert spoon

E-2080-15-12

l: 181 mm
thk: 3 mm

PLN / EUR: 10,58 / -



Nóż przystawkowy
Dessert knife

E-2080-6-12

l: 203 mm
wgt: 50 g

PLN / EUR: 10,77 / -



Widelczyk do ciasta
Cake fork

E-2080-4-12

l: 143 mm
thk: 2,5 mm

PLN / EUR: 8,55 / -



Łyżka do herbaty
Tea spoon

E-2080-3-12

l: 140 mm
thk: 2,5 mm

PLN / EUR: 6,52 / -



Łyżeczka do espresso
Espresso spoon

E-2080-26-12

l: 118 mm
thk: 2,2 mm

PLN / EUR: 5,89 / -



Łyżka do latte
Latte spoon

E-2080-25-12

l: 200 mm
thk: 3,2 mm

PLN / EUR: 24,68 / -



Widelec do ryb
Fish fork

E-2080-16-12

l: 187 mm
thk: 3 mm

PLN / EUR: 14,97 / -



Nóż do ryb
Fish knife

E-2080-17-12

l: 197 mm
thk: 3 mm

PLN / EUR: 11,74 / -



Nóż do steków
Steak knife

E-2080-45-12

l: 225 mm
wgt: 68 g

PLN / EUR: 21,16 / -



ALASKA 18/10



Łyżka do bulionu
Broth spoon

E-2080-33-12

l: 182 mm
thk: 3,2 mm

PLN/EUR: 11,40 / -



Łyżka do sosów; 18/10
Sauce spoon

E-2080-11-1

l: 171 mm
thk: 3,5 mm

PLN/EUR: 90,34 / -



Nóż do masła
Butter knife

E-2080-40-12

l: 160 mm
wgt: 30 g

PLN/EUR: 12,90 / -



Chochelka do zupy
Ladle

E-2080-7-1

l: 165 mm
thk: 3,5 mm

PLN/EUR: 90,34 / -



Łyżka do serwowania
Serving spoon

E-2080-12-1

l: 251 mm
thk: 3,5 mm

PLN/EUR: 63,94 / -



Widelec do spaghetti
Spaghetti fork

E-2080-35-12

l: 220 mm
thk: 3,5 mm

PLN/EUR: 15,12 / -



Łyżka do spaghetti; 18/10
Spaghetti spoon; 18/10

E-2080-36-12

l: 213 mm
thk: 3,5 mm

PLN/EUR: 15,12 / -



Zestaw do sałaty
Salad set; 18/10

E-2080-10-1

l: 238 mm
thk: 3,5 mm

PLN/EUR: 90,34 / -



Łopatka do tortu
Cake server

E-2080-8-1

l: 259 mm
thk: 3,5 mm

PLN/EUR: 89,64 / -



ATLANTIS 18/10



Widelec stołowy
Table fork

E-3010-1-12

l: 212 mm
thk: 4 mm

PLN / EUR: 14,78 / -



Łyżka stołowa
Table spoon

E-3010-2-12

l: 211 mm
thk: 4 mm

PLN / EUR: 14,78 / -



Nóż stołowy
Table knife

E-3010-5-12

l: 236 mm
wgt: 111 g

PLN / EUR: 14,18 / -



Nóż stołowy
Table knife

E-3010-5V-12

l: 233 mm
wgt: 100 g

PLN / EUR: 25,60 / -



Widelc przystawkowy
Dessert fork

E-3010-14-12

l: 187 mm
thk: 3 mm

PLN / EUR: 11,68 / -



Łyżka przystawkowa
Dessert spoon

E-3010-15-12

l: 185 mm
thk: 3 mm

PLN / EUR: 11,68 / -



Nóż przystawkowy
Dessert knife

E-3010-6-12

l: 211 mm
wgt: 78 g

PLN / EUR: 12,43 / -



Nóż przystawkowy
Dessert knife

E-3010-6V-12

l: 212 mm
wgt: 78 g

PLN / EUR: 23,57 / -



Widelczyk do ciasta
Cake fork

E-3010-4-12

l: 147 mm
thk: 2,5 mm

PLN / EUR: 6,79 / -



Łyżeczka do herbaty
Tea spoon

E-3010-3-12

l: 144 mm
thk: 2,5 mm

PLN / EUR: 6,57 / -



Łyżeczka do espresso
Espresso spoon

E-3010-26-12

l: 114 mm
thk: 2,5 mm

PLN / EUR: 5,92 / -



Łyżka do latte
Latte spoon

E-3010-25-12

l: 208 mm
thk: 2,8 mm

PLN / EUR: 19,48 / -



ATLANTIS 18/10



Widelec do ryb
Fish fork

E-3010-16-12

l: 187 mm
thk: 3 mm

PLN/EUR: 11,68 / -



Nóż do ryb
Fish knife

E-3010-17-12

l: 200 mm
thk: 3 mm

PLN/EUR: 11,82 / -



Nóż do steków
Steak knife

E-3010-45-12

l: 238 mm
wgt: 108 g

PLN/EUR: 14,89 / -



Łyżka do bulionu
Broth spoon

E-3010-33-12

l: 173 mm
thk: 3 mm

PLN/EUR: 11,86 / -



Nóż do masła
Butter knife

E-3010-40-12

l: 165 mm
wgt: 39 g

PLN/EUR: 18,02 / -



Łyżka do sosów; 18/10
Sauce spoon

E-3010-11-1

l: 186 mm
thk: 4 mm

PLN/EUR: 72,93 / -



Chochelka do zupy
Ladle

E-3010-7-1

l: 294 mm
thk: 3 mm

PLN/EUR: 86,76 / -



Widelec do serwowania
Serving fork

E-3010-21-1

l: 246 mm
thk: 3,5 mm

PLN/EUR: 52,26 / -



Łyżka łyżka do serwowania
Serving spoon; 18/10

E-3010-12-1

l: 225 mm
thk: 3,5 mm

PLN/EUR: 51,34 / -



Zestaw do sałaty
Salad set; 18/10

E-3010-10-1

l: 292 mm
thk: 3,5 mm

PLN/EUR: 103,96 / -



Łopatka do tortu
Cake server

E-3010-8-1

l: 256 mm
thk: 4 mm

PLN/EUR: 67,64 / -



ANSER 18/10



Widelec stołowy
Table fork

E-1670-1-12

l: 209 mm
thk: 3 mm

PLN / EUR: 13,72 / -



Łyżka stołowa
Table spoon

E-1670-2-12

l: 208 mm
thk: 3 mm

PLN / EUR: 13,72 / -



Nóż stołowy
Table knife

E-1670-5-12

l: 236 mm
wgt: 113 g

PLN / EUR: 14,02 / -



Nóż do steków
Steak knife

E-1670-45-12

l: 235 mm
wgt: 113 g

PLN / EUR: 18,02 / -



Widelec przystawkowy
Dessert fork

E-1670-14-12

l: 185 mm
thk: 2,5 mm

PLN / EUR: 11,30 / -



Łyżka przystawkowa
Dessert spoon

E-1670-15-12

l: 185 mm
thk: 2,5 mm

PLN / EUR: 11,30 / -



Nóż przystawkowy
Dessert knife

E-1670-6-12

l: 213 mm
wgt: 91 g

PLN / EUR: 11,75 / -



Widelczyk do ciasta
Cake fork

E-1670-4-12

l: 147 mm
thk: 2,2 mm

PLN / EUR: 8,07 / -



Łyżeczka do herbaty
Tea spoon

E-1670-3-12

l: 144 mm
thk: 2,2 mm

PLN / EUR: 6,67 / -



Łyżeczka do espresso
Espresso spoon

E-1670-26-12

l: 119 mm
thk: 2,2 mm

PLN / EUR: 6,76 / -



Łyżka do latte
Latte spoon

E-1670-25-12

l: 194 mm
thk: 2,5 mm

PLN / EUR: 29,80 / -



Widelec do ryb
Fish fork

E-1670-16-12

l: 178 mm
thk: 2,5 mm

PLN / EUR: 11,69 / -



Nóż do ryb
Fish knife

E-1670-17-12

l: 198 mm
thk: 2,5 mm

PLN / EUR: 15,31 / -



ANSER 18/10



Łyżka do bulionu
Broth spoon

E-1670-33-12
l: 173 mm
thk: 2,5 mm
PLN/EUR: 20,04 / -



Nóż do masła
Butter knife

E-1670-40-12
l: 162 mm
wgt: 48 g
PLN/EUR: 15,79 / -



Łyżka do sosów; 18/10
Sauce spoon

E-1670-11-1
l: 174 mm
thk: 2,5 mm
PLN/EUR: 105,78 / -



Zestaw do sałaty
Salad set; 18/10

E-1670-10-1
l: 210 mm
thk: 2,5 mm
PLN/EUR: 105,78 / -



Łopatką do tortu
Cake fork

E-1670-8-1
l: 245 mm
thk: 3 mm
PLN/EUR: 90,32 / -



Widelec do serwowania mięsa
Serving fork

E-1670-23-1
l: 245 mm
PLN/EUR: 366,36 / -



Nóż do serwowania mięsa
Serving knife

E-1670-24-1
l: 290 mm
PLN/EUR: 366,36 / -



Widelec do ostryg
Oyster fork

E-1670-19-12
l: 136 mm
thk: 2,5 mm
PLN/EUR: 13,33 / -



Widelec do ślimaków
Snails fork

E-1670-20-12
l: 143 mm
thk: 2 mm
PLN/EUR: 33,33 / -



Łyżka do lodów
Ice cream spoon

E-1670-18-12
l: 138 mm
thk: 2 mm
PLN/EUR: 33,33 / -



Nóż do sera, osadzony
Cheese knife, hollow handle

E-1670-28-1
l: 200 mm
PLN/EUR: 315,64 / -



Widelec do serwowania
Serving fork

E-1670-21-1
l: 214 mm
thk: 2,5 mm
PLN/EUR: 81,72 / -



Łyżka do serwowania
Serving spoon

E-1670-12-1
l: 224 mm
thk: 2,5 mm
PLN/EUR: 74,29 / -



BAGUETTE LM 18/10



			Nr kat.	l mm	thk mm	PLN	EUR
Widelec stołowy	Table fork		E-2610-1-12	209	2,5	11,93	-
Łyżka stołowa	Table spoon		E-2610-2-12	210	2,5	11,93	-
Nóż stołowy	Table knife		E-2610-5-12	239		14,35	-
Nóż stołowy, osadzony	Table knife, hollow handle		E-1610-51-12	250		42,46	-
Widelec przystawkowy	Dessert fork		E-2610-14-12	181	2,2	11,64	-
Łyżka przystawkowa	Dessert spoon		E-2610-15-12	181	2,2	11,64	-
Nóż przystawkowy	Dessert knife		E-2610-6-12	213		15,46	-
Nóż przystawkowy, osadzony	Dessert knife, hollow handle		E-1610-61-12	221		42,89	-
Widelczyk do ciasta	Cake fork		E-2610-4-12	143	2	6,76	-
Łyzeczka do herbaty	Tea spoon		E-2610-3-12	138	2	6,18	-
Łyzeczka do espresso	Espresso spoon		E-2610-26-12	112	1,8	6,18	-
Łyżka do latte	Latte spoon		E-1610-25-12	201	3	13,77	-
Widelec do ryb	Fish fork		E-2610-16-12	174	2,2	11,35	-
Nóż do ryb	Fish knife		E-2610-17-12	195	2,2	12,27	-
Nóż do steków	Steak knife		E-1610-45-12	236		48,35	-
Nóż do masła	Butter knife		E-1610-40-12	165		15,07	-
Łyżka do bulionu	Broth spoon		E-2610-33-12	175	2,2	11,64	-
Łyżka do sosów; 18/10	Sauce spoon		E-1610-11-1	168	3,5	105,29	-
Łyżka do serwowania	Serving spoon		E-1610-12-1	248	3,5	64,92	-
Chochelka do zupy	Ladle		E-1610-7-1	284	3,5	102,20	-
Zestaw do sałaty	Salad set; 18/10		E-1610-10-1	203	3,5	87,13	-
Łopatka do tortu	Cake server		E-1610-8-1	252	4	87,23	-

SONATE 18/10















			Nr kat.	l mm	thk mm	PLN	EUR
Widelec stołowy	Table fork		E-977-1-12	199	3	10,77	-
Łyżka stołowa	Table spoon		E-977-2-12	199	3	10,77	-
Nóż stołowy mono	Table knife		E-977-5-12	219		10,01	-
Widelec przystawkowy	Dessert fork		E-977-14-12	181	2,2	7,97	-
Łyżka przystawkowa	Dessert spoon		E-977-15-12	177	2,2	7,97	-
Nóż przystawkowy mono	Dessert knife mono		E-977-6-12	192		9,95	-
Widelczyk do ciasta	Cake fork		E-977-4-12	148	2	6,81	-
Łyzeczka do herbaty/kawy	Espresso spoon		E-977-3-12	143	2	5,99	-
Łyzeczka do espresso	Espresso spoon		E-977-26-12	114	1,8	6,28	-
Widelec do ryb	Fish fork		E-977-16-12	181	2,2	9,08	-
Nóż do ryb	Fish knife		E-977-17-12	205	2,2	9,08	-
Nóż do steków	Steak knife		E-977-45-12	229		10,54	-
Łyżka do bulionu	Broth spoon		E-977-33-12	176	2	8,89	-
Chochelka do zupy	Ladle		E-977-7-1	260	2,8	72,69	-
Łopatka do tortu	Cake server		E-977-8-1	255	2,8	34,39	-













OPERA 18/0



			Nr kat.	l mm	thk mm	PLN	EUR
Widelec stołowy	Table fork		E-968-1-12	209	2,5	9,23	-
Łyżka stołowa	Table spoon		E-968-2-12	208	2,5	9,23	-
Nóż stołowy	Table knife		E-968-5-12	240		9,20	-
Widelec przystawkowy	Dessert fork		E-968-14-12	186	2,5	7,68	-
Łyżka przystawkowa	Dessert spoon		E-968-15-12	185	2,5	7,68	-
Nóż przystawkowy	Dessert knife		E-968-6-12	204		8,56	-
Widelczyk do ciasta	Cake fork		E-968-4-12	144	2	5,80	-
Łyżeczka do herbaty	Tea spoon		E-968-3-12	144	2	5,12	-
Łyżeczka do espresso	Espresso spoon		E-968-26-12	120	2	5,07	-
Widelec do ryb	Fish fork		E-968-16-12	174	2,5	8,07	-
Nóż do ryb	Fish knife		E-968-17-12	197	2,5	9,66	-
Nóż do steków	Steak knife		E-968-45-12	223		19,85	-

RIVOLI 18/10















			Nr kat.	l mm	thk mm	PLN	EUR
Widelec stołowy	Table fork		E-1921-1-12	197	2,5	11,06	-
Łyżka stołowa	Table spoon		E-1921-2-12	200	2,5	11,06	-
Nóż stołowy	Table knife		E-1921-5-12	210		15,07	-
Widelec przystawkowy	Dessert fork		E-1921-14-12	179	2	9,50	-
Łyżka przystawkowa	Dessert spoon		E-1921-15-12	181	2	9,50	-
Nóż przystawkowy	Dessert knife		E-1921-6-12	190		14,87	-
Widelczyk do ciasta	Cake fork		E-1921-4-12	150	2	7,10	-
Łyżeczka do herbaty	Tea spoon		E-1921-3-12	145	2	6,67	-
Łyżeczka do espresso	Espresso spoon		E-1921-26-12	118	1,8	5,65	-
Widelec do ryb	Fish fork		E-1921-16-12	181	2	9,52	-
Nóż do ryb	Fish knife		E-1921-17-12	203	2	10,34	-



AUDE 18/0



			Nr kat.	l mm	thk mm	PLN	EUR
Wideliec stołowy	<i>Table fork</i>		E-1922-1-12	197	2,2	3,98	-
Łyżka stołowa	<i>Table fork</i>		E-1922-2-12	198	2,2	3,98	-
Nóż stołowy	<i>Table knife</i>		E-1922-5-12	230		10,11	-
Wideliec przystawkowy	<i>Dessert fork</i>		E-1922-14-12	178	2	3,78	-
Łyżka przystawkowa	<i>Dessert spoon</i>		E-1922-15-12	178	2	3,78	-
Nóż przystawkowy	<i>Dessert knife</i>		E-1922-6-12	202		9,60	-
Widelczyk do ciasta	<i>Cake fork</i>		E-1922-4-12	153	1,8	2,91	-
Łyżeczka do herbaty	<i>Tea spoon</i>		E-1922-3-12	145	1,8	2,45	-
Łyżeczka do espresso	<i>Espresso spoon</i>		E-1922-26-12	116	1,5	2,13	-
Łyżka do latte	<i>Latte spoon</i>		E-1922-25-12	197	2	6,18	-
Wideliec do ryb	<i>Fish fork</i>		E-1922-16-12	203	2	4,48	-
Nóż do ryb	<i>Fish knife</i>		E-1922-17-12	203	1,8	4,58	-

SZTUĆCE DO STEKÓW



Nóż do steków/pizy
Steak/pizza knife

E-762
l: 223 mm
PLN/EUR: 4,83 / -



Nóż do steków/pizy
Steak/pizza knife

E-775
l: 250 mm
PLN/EUR: 23,91 / -



SZTUĆCE DO STEKÓW



Nóż do steków
Steak knife

E-773

l: 232 mm

PLN / EUR: 45,88 / –



Nóż do steków
Steak knife

E-999-45-12

l: 233 mm

PLN / EUR: 51,05 / –



Nóż do steków
Steak knife

AB-551

l: 229 mm

PLN / EUR: 14,72 / –

KUP ON-LINE



SZTUĆCE DO RYB, ŚLIMAKÓW I OWOCÓW MORZA



Szcypce do ślimaków
Snail tongs

T-5060

l: 170 mm

PLN / EUR: 46,92 / –



Widelec do homarów
Lobster fork

E-782-12

l: 204 mm

thk: 2,5 mm

PLN / EUR: 19,75 / –



Szcypce do skorupiaków; stal
Pilers for shellfish; steel

D-4685-00

PLN / EUR: 76,95 / –



Szcypce do homarów
Lobster tongs

E-3011-1

l: 180 mm

PLN / EUR: 221,99 / –

KUP ON-LINE



ZWIESEL to producent bezołowiowego szkła kryształowego TRITAN CRYSTAL. Marka ZWIESEL przez 150 lat tradycji stworzyła innowacyjne rozwiązania technologiczne, dzięki którym wyznacza standardy jakości i designu.

ZWIESEL is a manufacturer of TRITAN CRYSTAL lead-free crystal glass. 150 years of tradition: For 150 years ZWIESEL brand has created innovative technological solutions, thanks to which it sets quality and design standards.

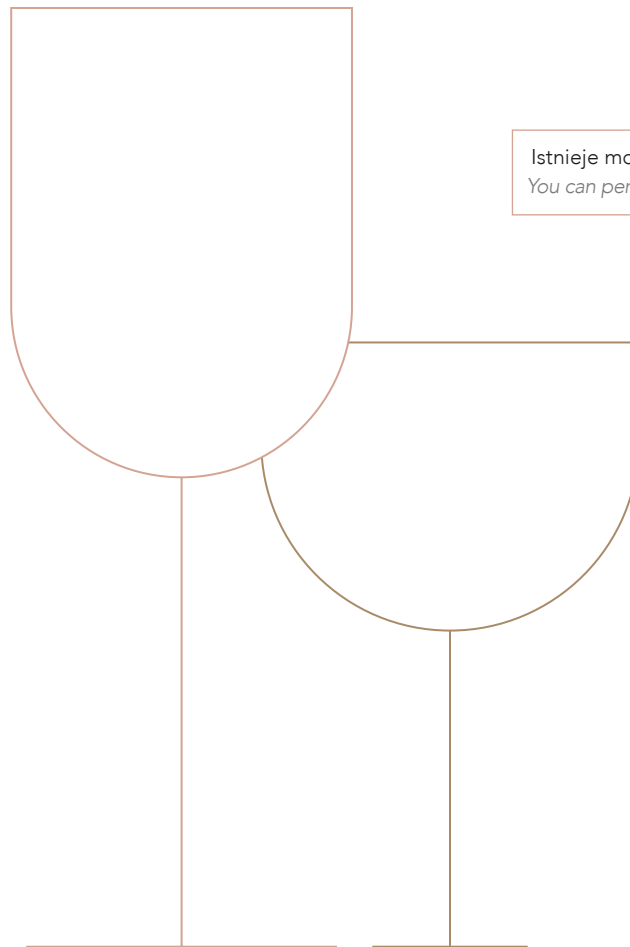

Istnieje możliwość personalizacji
You can personalize these products



TRITAN® GLASS PROTECT

Produkty wykonane z opatentowanej masy kryształowej pozbawionej baru i ołowiu. Skład udoskonalony jest tlenkiem tytanu i cyrkonem co daje wyjątkową przejrzystość i połysk, a zarazem wysoką odporność na zarysowania i wyszczerbienia podczas mycia.

Products made of patented barium and lead-free crystal glass. The composition is refined with titanium oxide and zirconium, which gives exceptional clarity and gloss, and at the same time high resistance to scratches and nicks during washing



KRYSTALICZNIE
PRZEZROCZYSTE SZKŁO/
CRYSTAL-CLEAR
TRANSPARENT GLASS



WYJĄTKOWO ODPORNE
NA USZKODZENIA/
EXTREMELY RESISTANT
TO DAMAGE



MADE IN
GERMANY/
MADE IN
GERMANY



PRODUKCJA PRZYJAZNA
ŚRODOWISKU/
ECO FRIENDLY PRODUCTION



WOLNE OD
OŁOWIU/
LEAD FREE



MOŻNA MYĆ
W ZMYWARCE/
CAN BE WASHED
IN A DISHWASHER



Dzięki punktowi musującemu bąbelki kumulują się w centralnym miejscu na dnie czaszy kieliszka i ulatniają się w postaci perlistej smugi.

Thanks to the sparkling point, the bubbles accumulate in a central place at the bottom of the glass bowl and are released slowly in the form of a pearly streak.

VOLUME



Allround

SH-9080-0-6

572 ml, op. 6
h: 222 mm, Ø: 92 mm
PLN/EUR: 38,51 / -

205958



Champagne

SH-9080-77-6

395 ml, op. 6
h: 229 mm, Ø: 74 mm
PLN/EUR: 38,51 / -

305958



Martini

SH-9080-86-6

166 ml, op. 6
h: 157 mm, Ø: 101 mm
PLN/EUR: 38,51 / -

165638



Cocktail

SH-9080-87-6

277 ml, op. 6
h: 145 mm, Ø: 104 mm
PLN/EUR: 38,51 / -

165534



Gin Tonic

SH-9080-80-6

630 ml, op. 6
h: 206 mm, Ø: 106 mm
PLN/EUR: 38,51 / -

165800



Grappa

SH-9080-155-6

147 ml, op. 6
h: 190 mm, Ø: 58 mm
PLN/EUR: 38,51 / -

495800



Tumbler

SH-9080-14-6

314 ml, op. 6
h: 148 mm, Ø: 61 mm
PLN/EUR: 31,88 / -

365534



KUP ON-LINE



Whisky

SH-9080-60-6

399 ml, op. 6
h: 90 mm, Ø: 89 mm
PLN/EUR: 31,88 / -

205318



Whisky

SH-9080-89-6

200 ml, op. 6
h: 80 mm, Ø: 71 mm
PLN/EUR: 31,88 / -

365318



Longdrink

SH-9080-79-6

480 ml, op. 6
h: 165 mm, Ø: 71 mm
PLN/EUR: 31,88 / -

365638



Allround

SH-9080-42-6

411 ml, op. 6
h: 132 mm, Ø: 71 mm
PLN/EUR: 31,88 / -

365434



**Bordeaux**

SH-8950-130-6

742 ml, op. 6
h: 245 mm, Ø: 100 mm

PLN/EUR: 51,61 / -

16S958

**Burgund**

SH-8950-140-6

955 ml, op. 6
h: 236 mm, Ø: 120 mm

PLN/EUR: 51,61 / -

9S958

**Riesling**

SH-8950-0-6

406 ml, op. 6
h: 225 mm, Ø: 80 mm

PLN/EUR: 51,61 / -

25S900

**Chardonnay**

SH-8950-1-6

487 ml, op. 6
h: 238 mm, Ø: 84 mm

PLN/EUR: 51,61 / -

25S900

**Sweet wine**

SH-8950-3-6

290 ml, op. 6
h: 212 mm, Ø: 72 mm

PLN/EUR: 51,61 / -

36S800

**Universal**

SH-8950-145-6

685 ml, op. 6
h: 230 mm, Ø: 105 mm

PLN/EUR: 51,61 / -

16S900

**Champagne**

SH-8950-77-6

348 ml, op. 6
h: 230 mm, Ø: 72 mm

PLN/EUR: 51,61 / -

36S900

**Universal**

SH-8950-42-6

485 ml, op. 6
h: 115 mm, Ø: 87 mm

PLN/EUR: 34,25 / -

25S434

**Water**

SH-8950-60-6

398 ml, op. 6
h: 90 mm, Ø: 91 mm

PLN/EUR: 34,25 / -

20S318



WINESHINE



Bordeaux

SH-9040-22-6
561 ml, op. 6
h: 242 mm, Ø: 90 mm
PLN / EUR: 42,96 / -
📦 20S958



Red wine

SH-9040-1-6
613 ml, op. 6
h: 243 mm, Ø: 94 mm
PLN / EUR: 42,96 / -
📦 20S958



White wine

SH-9040-2-6
296 ml, op. 6
h: 218 mm, Ø: 74 mm
PLN / EUR: 42,96 / -
📦 30S958



Champagne

SH-9040-77-6
288 ml, op. 6
h: 240 mm, Ø: 74 mm
PLN / EUR: 42,96 / -
📦 30S958



Universal

SH-9040-42-6
373 ml, op. 6
h: 104 mm, Ø: 81 mm
PLN / EUR: 33,94 / -
📦 25S418



KUP ON-LINE

FINESSE



Burgundy

SH-8800-140-6
660 ml, op. 6
h: 233 mm, Ø: 107 mm
PLN / EUR: 27,17 / -
📦 16S900



Bordeaux

SH-8800-130-6
630 ml, op. 6
h: 261 mm, Ø: 98 mm
PLN / EUR: 27,17 / -
📦 20S1114



White wine

SH-8800-0-6
385 ml, op. 6
h: 229 mm, Ø: 85 mm
PLN / EUR: 27,17 / -
📦 25S900



Sparkling wine

SH-8800-77-6
297 ml, op. 6
h: 238 mm, Ø: 74 mm
PLN / EUR: 27,17 / -
📦 30S958

KUP ON-LINE

**Bordeaux**

SH-8545-130-6

680 ml, op. 6
h: 267 mm, Ø: 94 mm

PLN/EUR: 31,48 / -

**Burgundy**

SH-8545-140-6

692 ml, op. 6
h: 234 mm, Ø: 114 mm

PLN/EUR: 31,48 / -

 95958
**Cabernet**

SH-8545-1-6

540 ml, op. 6
h: 244 mm, Ø: 92 mm

PLN/EUR: 31,48 / -

 205958
**Sauvignon Blanc**

SH-8545-0-6

408 ml, op. 6
h: 232 mm, Ø: 84 mm

PLN/EUR: 31,48 / -

 255900
**Riesling**

SH-8545-2-6

300 ml, op. 6
h: 220 mm, Ø: 76 mm

PLN/EUR: 28,77 / -

 205958
**Sparkling wine**

SH-8545-7-6

209 ml, op. 6
h: 252 mm, Ø: 72 mm

PLN/EUR: 28,77 / -

 365958
**Martini**

SH-8545-86-6

343 ml, op. 6
h: 180 mm, Ø: 114 mm

PLN/EUR: 40,03 / -

 95800Y
**Brandy**

SH-8545-47-6

612 ml, op. 6
h: 171 mm, Ø: 112 mm

PLN/EUR: 37,04 / -

 95638
**Universal**

SH-8545-15-6

246 ml, op. 6
h: 140 mm, Ø: 60 mm

PLN/EUR: 29,19 / -

 495638
**Whisky Old Fashioned**

SH-8545-60-6

389 ml, op. 6
h: 90 mm, Ø: 96 mm

PLN/EUR: 33,45 / -

 205318
**Universal**

SH-8545-42-6

357 ml, op. 6
h: 144 mm, Ø: 70 mm

PLN/EUR: 32,25 / -

 365534

SENSA



Velvety & Sumptuous

SH-8890-140-6

710 ml, op. 6
h: 230 mm, Ø: 105 mm

PLN/EUR: 22,90 / -

16S900



Flavoursome & Spicy

SH-8890-130-6

660 ml, op. 6
h: 243 mm, Ø: 94 mm

PLN/EUR: 22,90 / -

20S958



Fruity & Delicate

SH-8890-1-6

535 ml, op. 6
h: 236 mm, Ø: 88 mm

PLN/EUR: 22,90 / -

20S958



Light & Fresh

SH-8890-2-6

363 ml, op. 6
h: 222 mm, Ø: 76 mm

PLN/EUR: 22,90 / -

30S958



Universal

SH-8890-42-6

500 ml, op. 6
h: 120 mm, Ø: 84 mm

PLN/EUR: 22,90 / -

25S434



Light & Fresh Sparkling

SH-8890-77-6

388 ml, op. 6
h: 240 mm, Ø: 72 mm

PLN/EUR: 22,90 / -

36S958

KUP ON-LINE

FORTISSIMO

*Bordeaux*

SH-8560-130-6

650 ml, op. 6
h: 271 mm, Ø: 93 mm

PLN/EUR: 30,54 / -

16S1058

*Red wine / Water*

SH-8560-1-6

505 ml, op. 6
h: 258 mm, Ø: 88 mm

PLN/EUR: 30,54 / -

25S658

*Burgundy*

SH-8560-140-6

740 ml, op. 6
h: 248 mm, Ø: 111 mm

PLN/EUR: 30,54 / -

9S958Y

*White wine*

SH-8560-0-6

420 ml, op. 6
h: 248 mm, Ø: 82 mm

PLN/EUR: 30,54 / -

25S958

*Sparkling wine*

SH-8560-7-6

240 ml, op. 6
h: 267 mm, Ø: 74 mm

PLN/EUR: 30,54 / -

25S1058



DIVA

*Bordeaux Goblet*

SH-8015-130-6

800 ml, op. 6
h: 275 mm, Ø: 99 mm

PLN/EUR: 32,11 / -

16S1058

*Burgundy Goblet*

SH-8015-140-6

839 ml, op. 6
h: 248 mm, Ø: 116 mm

PLN/EUR: 32,11 / -

9S958Y

*Burgundy*

SH-8015-0-6

480 ml, op. 6
h: 229 mm, Ø: 91 mm

PLN/EUR: 32,11 / -

16S900

*Water / Red wine*

SH-8015-1-6

613 ml, op. 6
h: 247 mm, Ø: 100 mm

PLN/EUR: 32,11 / -

16S958

*White wine*

SH-8015-2-6

302 ml, op. 6
h: 230 mm, Ø: 73 mm

PLN/EUR: 32,11 / -

36S900

*Sparkling wine*

SH-8015-7-6

219 ml, op. 6
h: 253 mm, Ø: 72 mm

PLN/EUR: 32,11 / -

36S958



TASTE



Bordeaux

SH-8741-130-6

656 ml, op. 6
h: 237 mm, Ø: 96 mm

PLN/EUR: 19,19 / -

📦 20S958



Burgundy

SH-8741-140-6

790 ml, op. 6
h: 227 mm, Ø: 111 mm

PLN/EUR: 19,19 / -

📦 9S958Y



Red wine

SH-8741-1-6

497 ml, op. 6
h: 225 mm, Ø: 87 mm

PLN/EUR: 19,19 / -

📦 25S900



White wine

SH-8741-0-6

356 ml, op. 6
h: 211 mm, Ø: 79 mm

PLN/EUR: 19,19 / -

📦 30S800



Sparkling wine

SH-8741-7-6

283 ml, op. 6
h: 231 mm, Ø: 70 mm

PLN/EUR: 19,19 / -

📦 36S900



IVENTO



Burgundy

SH-8740-140-6

783 ml, op. 6
h: 221 mm, Ø: 111 mm

PLN/EUR: 15,77 / -

📦 9S958Y



Bordeaux

SH-8740-130-6

633 ml, op. 6
h: 235 mm, Ø: 92 mm

PLN/EUR: 15,77 / -

📦 16S900



Red wine

SH-8740-1-6

506 ml, op. 6
h: 224 mm, Ø: 87 mm

PLN/EUR: 15,77 / -

📦 25S900



White wine

SH-8740-0-6

349 ml, op. 6
h: 208 mm, Ø: 77 mm

PLN/EUR: 15,77 / -

📦 25S800



Sparkling wine

SH-8740-7-6

228 ml, op. 6
h: 222 mm, Ø: 70 mm

PLN/EUR: 15,77 / -

📦 36S900



KUP ON-LINE



KUP ON-LINE



BANQUET

*Bordeaux*

SH-8940-130-6

600 ml, op. 6
h: 223 mm, Ø: 93 mm

PLN/EUR: 12,26 / -

20S958

*Burgundy*

SH-8940-140-6

630 ml, op. 6
h: 210 mm, Ø: 101 mm

PLN/EUR: 12,26 / -

16S800

*Red wine/water*

SH-8940-1-6

475 ml, op. 6
h: 213 mm, Ø: 86 mm

PLN/EUR: 12,26 / -

25S800

*Chardonnay*

SH-8940-0-6

368 ml, op. 6
h: 200 mm, Ø: 80 mm

PLN/EUR: 12,26 / -

25S800

*White wine*

SH-8940-2-6

300 ml, op. 6
h: 182 mm, Ø: 76 mm

PLN/EUR: 12,26 / -

30S800

*Champagne*

SH-8940-7-6

210 ml, op. 6
h: 221 mm, Ø: 70 mm

PLN/EUR: 12,26 / -

36S900

*Water*

SH-8940-32-6

253 ml, op. 6
h: 138 mm, Ø: 69 mm

PLN/EUR: 12,26 / -

36S534



CONGRESSO

*Bordeaux*

SH-8608-130-6

621 ml, op. 6
h: 222 mm, Ø: 93 mm

PLN/EUR: 15,01 / -

20S958

*Red wine*

SH-8608-0-6

355 ml, op. 6
h: 195 mm, Ø: 77 mm

PLN/EUR: 15,01 / -

30S800

*Water / Red wine*

SH-8608-1-6

455 ml, op. 6
h: 205 mm, Ø: 83 mm

PLN/EUR: 15,01 / -

25S800

*White wine*

SH-8608-2-6

317 ml, op. 6
h: 182 mm, Ø: 74 mm

PLN/EUR: 15,01 / -

30S800

*Sparkling wine*

SH-8608-7-6

235 ml, op. 6
h: 207 mm, Ø: 66 mm

PLN/EUR: 15,01 / -

4846S800



WINE TASTING



Kieliszek degustacyjny

SH-8636-4-6

227 ml, op. 6
h: 167 mm, Ø: 72 mm

PLN / EUR: 36,11 / -

365638



Kieliszek degustacyjny

SH-8177-0-6

299 ml, op. 6
h: 182 mm, Ø: 75 mm

PLN / EUR: 34,25 / -

305800



Kraszuarka; szkło

SH-2784-339-1

h: 339 mm, Ø: 197 mm

PLN / EUR: 353,58 / -



Kieliszek degustacyjny

SH-8177-6

299 ml, op.
h: 182 mm, Ø: 75 mm

PLN / EUR: 63,51 / -

305800



KUP ON-LINE



DEKANTERY I KARAFKI, COOLERY I AKCESORIA / DECANTERS



Dekanter Cirquo

SH-2834-075L-1

750 ml
h: 310 mm, Ø: 340 mm

PLN / EUR: 1 244,15 / -



Karafka Fresca

SH-2851-1L-1

1000 ml
h: 337 mm, Ø: 100 mm

PLN / EUR: 182,34 / -



Karafka Basic Bar

SH-8750-075-1

750 ml
h: 321 mm, Ø: 87 mm

PLN / EUR: 198,67 / -



Dekanter Diva

SH-2702-10L-1

1000 ml
h: 226 mm, Ø: 224 mm

PLN / EUR: 292,60 / -



Stojak do suszenia dekantera

AB-5402

h: 300 mm

PLN / EUR: 36,70 / -



Kulki do czyszczenia dekanterów; 18/10

PG-230241

PLN / EUR: 49,08 / -



KUP ON-LINE



SHOW

*Longdrink*

SH-8990-79-6

368 ml, op. 6
h: 150 mm, Ø: 70 mm

PLN/EUR: 21,21 / -

365534

*Whisky*

SH-8990-60-6

334 ml, op. 6
h: 94 mm, Ø: 82 mm

PLN/EUR: 21,21 / -

255418



STAGE

*Longdrink*

SH-9010-79-6

440 ml, op. 6
h: 150 mm, Ø: 76 mm

PLN/EUR: 21,21 / -

305638

*Whisky*

SH-9010-60-6

364 ml, op. 6
h: 92 mm, Ø: 86 mm

PLN/EUR: 21,21 / -

255418



PERSPECTIVE



Longdrink

SH-9050-79-6
480 ml, op. 6
h: 165 mm, Ø: 71 mm
PLN/EUR: 35,71 / -
📦 365638



Whisky

SH-9050-60-6
399 ml, op. 6
h: 90 mm, Ø: 89 mm
PLN/EUR: 35,71 / -
📦 205318



Universal

SH-9050-42-6
411 ml, op. 6
h: 132 mm, Ø: 71 mm
PLN/EUR: 35,71 / -
📦 365434



KUP ON-LINE 

MELODY



Longdrink

SH-9030-79-6
499 ml, op. 6
h: 146 mm, Ø: 78 mm
PLN/EUR: 35,39 / -
📦 305638



Whisky

SH-9030-60-6
400 ml, op. 6
h: 85 mm, Ø: 95 mm
PLN/EUR: 35,39 / -
📦 205318



Universal

SH-9030-42-6
392 ml, op. 6
h: 134 mm, Ø: 72 mm
PLN/EUR: 35,39 / -
📦 365534



KUP ON-LINE 

VOLUME

*Tumbler*

SH-9080-14-6

314 ml, op. 6
h: 148 mm, Ø: 61 mm

PLN/EUR: 31,88 / -

365534

*Whisky*

SH-9080-60-6

399 ml, op. 6
h: 90 mm, Ø: 89 mm

PLN/EUR: 31,88 / -

205318

*Whisky*

SH-9080-89-6

200 ml, op. 6
h: 80 mm, Ø: 71 mm

PLN/EUR: 31,88 / -

365318

*Longdrink*

SH-9080-79-6

480 ml, op. 6
h: 165 mm, Ø: 71 mm

PLN/EUR: 31,88 / -

365638

*Allround*

SH-9080-42-6

411 ml, op. 6
h: 132 mm, Ø: 71 mm

PLN/EUR: 31,88 / -

365434



TAVORO

*Whisky*

SH-4858-60-6

302 ml, op. 6
h: 90 mm, Ø: 80 mm

PLN/EUR: 19,09 / -

255318

*Longdrink*

SH-4858-79-6

347 ml, op. 6
h: 156 mm, Ø: 62 mm

PLN/EUR: 19,09 / -

365638

*Beer*

SH-4858-42-6

311 ml, op. 6
h: 142 mm, Ø: 60 mm

PLN/EUR: 19,09 / -

495534

*Cocktail*

SH-4858-89-6

155 ml, op. 6
h: 80 mm, Ø: 62 mm

PLN/EUR: 14,44 / -

365318

*Shot*

SH-4858-35-6

50 ml, op. 6
h: 72 mm, Ø: 38 mm

PLN/EUR: 12,83 / -

495318



BASIC BAR CLASSIC / MOTION



CLASSIC



Longdrink

SH-8860-79-6
311 ml, op. 6
h: 156 mm, Ø: 61 mm
PLN/EUR: 66,50 / -
📦 365638



Double Old Fashioned

SH-8860-60-6
369 ml, op. 6
h: 95 mm, Ø: 89 mm
PLN/EUR: 66,50 / -
📦 205434



Cocktail

SH-8860-87-6
202 ml, op. 6
h: 129 mm, Ø: 102 mm
PLN/EUR: 71,16 / -
📦 165434



Mixing Jug

SH-8860-05-1
500 ml, op. 1
h: 150 mm, Ø: 96 mm
PLN/EUR: 179,55 / -
📦 165534

MOTION



Longdrink

SH-8860M-79-6
311 ml, op. 6
h: 156 mm, Ø: 61 mm
PLN/EUR: 66,50 / -
📦 365638



Double Old Fashioned

SH-8860M-60-6
369 ml, op. 6
h: 95 mm, Ø: 89 mm
PLN/EUR: 66,50 / -
📦 205434



Cocktail

SH-8860M-87-6
202 ml, op. 6
h: 129 mm, Ø: 102 mm
PLN/EUR: 71,16 / -
📦 165434



Mixing Jug

SH-8860M-05-1
500 ml, op. 1
h: 150 mm, Ø: 96 mm
PLN/EUR: 179,55 / -
📦 165534

VINA

*Universal*

SH-8465-79-6
548 ml, op. 6
h: 127 mm, Ø: 90 mm
PLN/EUR: 19,76 / -
📦 20S434

*Water*

SH-8796-42-6
397 ml, op. 6
h: 114 mm, Ø: 81 mm
PLN/EUR: 19,76 / -
📦 25S434

*Wine Tumbler*

SH-8465-60-6
587 ml, op. 6
h: 101 mm, Ø: 105 mm
PLN/EUR: 19,76 / -
📦 16S418

SOFTDRINKS

*Softdrink nr.3*

SH-8750-380-6
387 ml, op. 6
h: 152 mm, Ø: 69 mm
PLN/EUR: 28,53 / -
📦 36S535

*Softdrink nr.2*

SH-8750-540-6
539 ml, op. 6
h: 130 mm, Ø: 88 mm
PLN/EUR: 28,53 / -
📦 20S434

*Softdrink nr.1*

SH-8750-200-6
213 ml, op. 6
h: 86 mm, Ø: 70 mm
PLN/EUR: 25,80 / -
📦 36S318



CONVENTION



Longdrink

SH-7745-79-6

370 ml, op. 6
h: 155 mm, Ø: 65 mm

PLN/EUR: 16,24 / -

365638



Beer Tumbler

SH-7745-42-6

320 ml, op. 6
h: 140 mm, Ø: 63 mm

PLN/EUR: 15,49 / -

365534



Water

SH-7745-12-6

255 ml, op. 6
h: 116 mm, Ø: 63 mm

PLN/EUR: 15,01 / -

365434



Whisky

SH-7745-60-6

285 ml, op. 6
h: 89 mm, Ø: 80 mm

PLN/EUR: 16,24 / -

255318

KUP ON-LINE

BAR SPECIAL



Wheat Beer

SH-8710-05-6

711 ml, op. 6
h: 255 mm, Ø: 85 mm

PLN/EUR: 35,44 / -

255958
odpowiednie do piwa 0,5 l



Wheat Beer Small

SH-8710-03-6

451 ml, op. 6
h: 217 mm, Ø: 73 mm

PLN/EUR: 29,73 / -

365800
odpowiednie do piwa 0,3 l



Lager

SH-8720-05L-6

678 ml, op. 6
h: 204 mm, Ø: 88 mm

PLN/EUR: 35,44 / -

205800
odpowiednie do piwa 0,5 l



Pint

SH-8720-06L-6

602 ml, op. 6
h: 157 mm, Ø: 89 mm

PLN/EUR: 35,44 / -

205638
odpowiednie do piwa 0,5 l



Water

SH-8512-32-6

344 ml, op. 6
h: 163 mm, Ø: 76 mm

PLN/EUR: 35,58 / -

305638



Pilsner

SH-8730-04L-6

513 ml, op. 6
h: 191 mm, Ø: 81 mm

PLN/EUR: 44,75 / -

255738



Pilsner

SH-8730-03L-6

405 ml, op. 6
h: 178 mm, Ø: 77 mm

PLN/EUR: 41,43 / -

305800

odpowiednie do piwa 0,3 l

KUP ON-LINE

BAR SPECIAL

Schumann's*Cocktail Hurricane*

SH-8512-300-6

530 ml, op. 6
h: 183 mm, Ø: 89 mm
PLN/EUR: 28,66 / -

365738

*Gin Tonic / Aperol Spritz*

SH-8512-80-6

710 ml, op. 6
h: 178 mm, Ø: 116 mm
PLN/EUR: 33,18 / -

95800Y

*Brandy XXL*

SH-8512-45-6

805 ml, op. 6
h: 165 mm, Ø: 118 mm
PLN/EUR: 39,37 / -

95638

*Liqueur Saucer*

SH-8512-16-6

70 ml, op. 6
h: 124 mm, Ø: 68 mm
PLN/EUR: 28,66 / -

365434

*Grappa*

SH-8213-155-6

95 ml, op. 6
h: 174 mm, Ø: 58 mm
PLN/EUR: 22,28 / -

495638

*Martini*

SH-8512-86-6

166 ml, op. 6
h: 157 mm, Ø: 101 mm
PLN/EUR: 43,16 / -

165638

*Martini*

SH-8545-86-6

343 ml, op. 6
h: 180 mm, Ø: 114 mm
PLN/EUR: 40,03 / -

95800Y





Margarita

SH-8512-166-6
305 ml, op. 6
h: 166 mm, Ø: 114 mm
PLN / EUR: 50,21 / -
95638



Martini

SH-8750-87-6
226 ml, op. 6
h: 129 mm, Ø: 102 mm
PLN / EUR: 34,11 / -
165434



Cocktail

SH-8750-88-6
259 ml, op. 6
h: 129 mm, Ø: 101 mm
PLN / EUR: 34,11 / -
165434



Whisky Nosing Glass

SH-8512-17-6
218 ml, op. 6
h: 175 mm, Ø: 66 mm
PLN / EUR: 33,18 / -
365900



Whisky Nosing Tumbler

SH-8512-120-6
322 ml, op. 6
h: 120 mm, Ø: 83 mm
PLN / EUR: 33,18 / -
255434



Liqueur

SH-7500-5-6
70 ml, op. 6
h: 132 mm, Ø: 52 mm
PLN / EUR: 12,26 / -
495434



Brandy

SH-8545-47-6
612 ml, op. 6
h: 171 mm, Ø: 112 mm
PLN / EUR: 37,04 / -
95638



Riesling

SH-8545-2-6
300 ml, op. 6
h: 220 mm, Ø: 76 mm
PLN / EUR: 28,77 / -
205958



Onis

Nowe projekty szklanek i kieliszków **Onis** wyznaczają trendy w designie użytkowym, zachowując jednocześnie niezbędne dla profesjonalistów funkcjonalności, takie jak sztaplowanie.

*The new designs of **Onis** glasses and goblets set trends in utility design, while retaining functionalities essential for professionals, such as stacking.*

Istnieje możliwość personalizacji
You can personalize these products

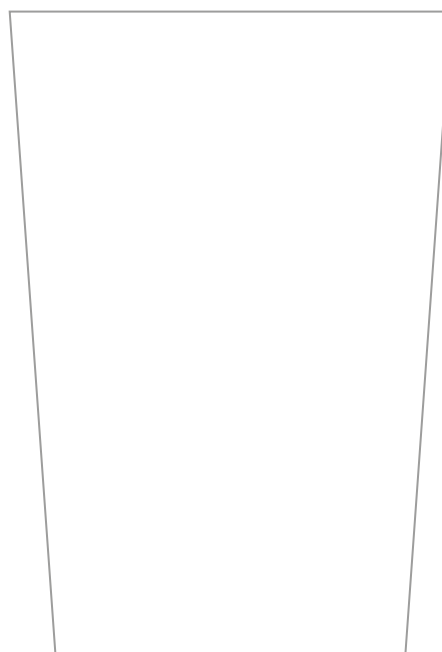
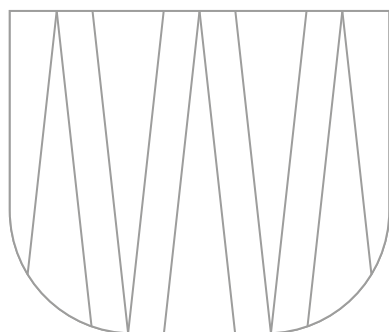

XTRATUFF

Dzięki **ONIS Xtratuff**, nie musisz iść na kompromis w kwestii wytrzymałości. Proces zastosowany podczas produkcji górnej części szkła dodaje twardości, trwałości i większej odporności na stłuczenia. Jest to niewątpliwie jedna z najlepszych technologii, przekładających się na trwałość i jakość szkła dla tak wymagającego sektora, jak HoReCa.

*With **ONIS Xtratuff**, you don't have to compromise on durability. The process used in the production of the top glass adds hardness, durability and greater resistance to breakage. This is undoubtedly one of the best technologies translating into durability and glass quality for such a demanding sector as HoReCa.*



Gdy krawędź szklanki lub kieliszka ukruszy się wymienimy produkt na nowy lub zwrócimy koszt zakupu.

When the edge of the glass is chipped we will replace the product with a new one or refund the purchase price.

✓ ukruszona krawędź
chipped edge



✗ ułamana / pęknięta krawędź
broken / cracked edge

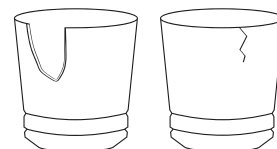

CO WYRÓŻNIA MARKE ONIS

WHAT SETS THE ONIS BRAND APART



Produkt posiada elegancką, cienką, lecz solidną nóżkę. Kieliszki te są wspaniałym tłem dla serwowanych napojów.

The product has an elegant thin yet robust stem. Proof that elegance can go hand in hand with sturdiness.

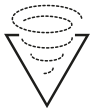

Naczynia szklane zaprojektowane tak, aby wydobyć maksimum aromatu i smaku z serwowanych napojów.

Glassware designed to bring out maximum aroma and flavor for increased quality perception in serves.

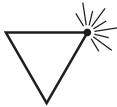

Produkt ma bardzo drobno polerowaną krawędź, która zapewnia elegancki wygląd i wyjątkowe doświadczenia podczas degustacji.

The product has a very fine polished rim for an elegant look & feel and refined drinking experience.



Oszczędzaj miejsce, dzięki możliwości sztaplowania.

The product is designed to be stacked for space saving purposes.



Ten specjalny proces zastosowany podczas produkcji wzmacnia górną część naczynia, który jest najbardziej narażony na stłuczenie. Zwiększa się odporność na szok termiczny i mechaniczny, dzięki czemu przedłuża jego żywotność.

This special thermal after-process strengthens the upper portion of the glass, the area most vulnerable to breakage. It increases the resistance to thermal and mechanical shock which results in remarkably durable glassware with prolonged service life.



Podczas produkcji kolor zostaje wtopiony w masę szkła, nie zostaje on nałożony w procesie końcowym. Jest zatem w pełni odporny na zmywanie i zarysowania.

The colour is embedded in the mass of the glass during its production, and not applied by an after-process, and therefore fully resistant to dishwashing and scratching.



Produkty te posiadają szerszą podstawę zapewniającą dodatkową stabilność a także nadają całości dodatkowej elegancji.

This product showcases a larger footplate for extra stability, granting an additional elegance to the piece. It is the perfect balance between form and functionality.



ON-02124-6
(LB-241020-12)

525 ml, op. 6
h: 213 mm, Ø: 91 mm
PLN/EUR: 12,63 / -

20S800



ON-03124-6
(LB-241037-12)

375 ml, op. 6
h: 202 mm, Ø: 83 mm
PLN/EUR: 12,63 / -

25S800



ON-04124-6
(LB-241044-12)

300 ml, op. 6
h: 194 mm, Ø: 77 mm
PLN/EUR: 12,17 / -

30S800



ON-17324-6
(LB-241730-12)

215 ml, op. 6
h: 214 mm, Ø: 69 mm
PLN/EUR: 12,27 / -

36S800



ON-3011-12
(LB-3011-12)

414 ml, op. 12
h: 208 mm, Ø: 86 mm

PLN/EUR: 16,41 / -

 25S800



ON-3057-12
(LB-3057-24)

320 ml, op. 12
h: 198 mm, Ø: 79 mm

PLN/EUR: 16,41 / -

 30S800



ON-3096-12
(LB-3096-12)

170 ml, op. 12
h: 215 mm, Ø: 47 mm

PLN/EUR: 16,41 / -

 36S800



ON-3055-12
(LB-3055-12)

250 ml, op. 12
h: 152 mm, Ø: 105 mm

PLN/EUR: 18,58 / -

 16S638



ON-3010-12
(LB-3010-12)

414 ml, op. 12
h: 165 mm, Ø: 86 mm

PLN/EUR: 17,47 / -

 25S638



ON-3911-12
(LB-3911-12)

355 ml, op. 12
h: 184 mm, Ø: 86 mm

PLN/EUR: 16,41 / -

 25S738



ON-3957-12
(LB-3957-12)

310 ml, op. 12
h: 183 mm, Ø: 72 mm

PLN/EUR: 16,41 / -

 36S738



ON-3965-12
(LB-3965-12)

250 ml, op. 12
h: 181 mm, Ø: 65 mm

PLN/EUR: 15,32 / -

 30S800



ON-3996-12
(LB-3996-12)

170 ml, op. 12
h: 196 mm, Ø: 48 mm

PLN/EUR: 16,41 / -

 36S800





RL-540468-6
(LB-541625-6)

530 ml, op. 6
h: 219 mm, Ø: 89 mm

PLN/EUR: 9,31 / -

205958



RL-540314-6
(LB-540628-6)

410 ml, op. 6
h: 206 mm, Ø: 83 mm

PLN/EUR: 9,26 / -

255800



RL-540345-6
(LB-540635-6)

320 ml, op. 6
h: 198 mm, Ø: 77 mm

PLN/EUR: 8,74 / -

305800



RL-540451-6
(LB-540673-6)

210 ml, op. 6
h: 214 mm, Ø: 63 mm

PLN/EUR: 9,26 / -

365800

~~odis~~



ON-231-12
(LB-231-12)

450 ml, op. 12
h: 115 mm, Ø: 89 mm

PLN/EUR: 10,04 / -

205434



RL-834277-6
(LB-925241-6)

330 ml, op. 6
h: 99 mm, Ø: 84 mm

PLN/EUR: 8,10 / -

255418



RL-260625-6
650 ml, op. 6
h: 246 mm, Ø: 99 mm
PLN/EUR: 14,70 / -
 165958



RL-265439-6
(LB-265217-6)
530 ml, op. 6
h: 217 mm, Ø: 91 mm
PLN/EUR: 13,23 / -
 205958



RL-260632-6
520 ml, op. 6
h: 241 mm, Ø: 91 mm
PLN/EUR: 14,00 / -
 205958



RL-265415-6
(LB-265033-6)
370 ml, op. 6
h: 217 mm, Ø: 82 mm
PLN/EUR: 12,85 / -
 255900



RL-265422-6
(LB-265057-6)
280 ml, op. 6
h: 207 mm, Ø: 76 mm
PLN/EUR: 12,85 / -
 305800



RL-265446-6
(LB-265712-6)
220 ml, op. 6
h: 230 mm, Ø: 69 mm
PLN/EUR: 12,85 / -
 365900



RL-260649-6
300 ml, op. 6
h: 173 mm, Ø: 106 mm
PLN/EUR: 14,00 / -
 165638





ON-18319-6

180 ml, op. 6
h: 201 mm, Ø: 67 mm

PLN/EUR: 13,08 / -

365800



ON-18419-6

180 ml, op. 6
h: 148 mm, Ø: 67 mm

PLN/EUR: 10,27 / -

365534



ON-18219-6

510 ml, op. 6
h: 128 mm, Ø: 106 mm

PLN/EUR: 13,08 / -

165434



ON-18019-6

250 ml, op. 6
h: 108 mm, Ø: 85 mm

PLN/EUR: 10,27 / -

255418



ON-3713VCP35-6

350 ml, op. 6
h: 91 mm, Ø: 98 mm

PLN/EUR: 14,95 / -

205434



ON-3713VCP18-6

185 ml, op. 6
h: 105 mm, Ø: 72 mm

PLN/EUR: 12,50 / -

365418



BRANDY

odis



ON-18219-6

510 ml, op. 6
h: 128 mm, Ø: 106 mm

PLN/EUR: 13,08 / -

165434



odis



ON-18019-6

250 ml, op. 6
h: 108 mm, Ø: 85 mm

PLN/EUR: 10,27 / -

255418

royal
leerdamRL-521047-6
(LB-521801-6)250 ml, op. 6
h: 102 mm, Ø: 81 mm

PLN/EUR: 8,86 / -

255418

royal
leerdamRL-18184-6
(LB-613186-6)370 ml, op. 6
h: 129 mm, Ø: 88 mm

PLN/EUR: 13,12 / -

205434



opis



ON-490015-12
(LB-8203-12)
40 ml, op. 12
h: 111 mm, Ø: 39 mm
PLN/EUR: 7,25 / -
 495434



RL-260700-6
90 ml, op. 6
h: 204 mm, Ø: 49 mm
PLN/EUR: 12,48 / -
 495800



N



RL-613223-6
(LB-613070-6)
130 ml, op. 6
h: 132 mm, Ø: 59 mm
PLN/EUR: 9,97 / -
 495434



RL-613278-6
(LB-613315-6)
90 ml, op. 6
h: 160 mm, Ø: 51 mm
PLN/EUR: 11,62 / -
 495638



ZWIESEL GLAS

SH-8213-155-6
95 ml, op. 6
h: 174 mm, Ø: 58 mm
PLN/EUR: 22,28 / -
 495638



ZWIESEL GLAS

SH-8512-16-6
70 ml, op. 6
h: 124 mm, Ø: 68 mm
PLN/EUR: 28,66 / -
 365434



RL-260014-12
(LB-260014-12)
40 ml, op. 12
h: 95 mm, Ø: 50 mm
PLN/EUR: 5,29 / -
 495434



ZWIESEL GLAS

SH-7500-5-6
70 ml, op. 6
h: 132 mm, Ø: 52 mm
PLN/EUR: 12,26 / -
 495434



ON-2388VCP06-12
65 ml, op. 12
h: 105 mm, Ø: 39 mm
PLN/EUR: 7,77 / -
 495318

N



ON-610024-12
45 ml, op. 12
h: 82 mm, Ø: 37 mm
PLN/EUR: 5,60 / -
 495318

N



ON-410051-12
45 ml, op. 12
h: 47 mm, Ø: 48 mm
PLN/EUR: 5,79 / -
 495318

N



ON-10002-6
75 ml, op. 6
h: 151 mm, Ø: 63 mm
PLN/EUR: 11,42 / -
 365534

N



ON-15733-12
(LB-15733-12)
110 ml, op. 12
h: 76 mm, Ø: 69 mm
PLN/EUR: 7,96 / -
 365318





ON-973-48
(LB-973-48)

60 ml, op. 48
h: 106 mm, Ø: 41 mm

PLN/EUR: 5,75 / -

49S434



ON-9862324-72
(LB-9862324-72)

40 ml, op. 72
h: 92 mm, Ø: 38 mm

PLN/EUR: 3,22 / -

49S434



ON-971-48
(LB-971-48)

30 ml, op. 48
h: 77 mm, Ø: 37 mm

PLN/EUR: 4,83 / -

49S318



ON-1650-12
(LB-1650-12)

75 ml, op. 12
h: 105 mm, Ø: 40 mm

PLN/EUR: 4,36 / -

49S434



ON-5109-24
(LB-5109-24)

60 ml, op. 24
h: 89 mm, Ø: 51 mm

PLN/EUR: 8,38 / -

49S318



ON-151-48
(LB-151-48)

30 ml, op. 48
h: 54 mm, Ø: 46 mm

PLN/EUR: 4,71 / -

49S318



ON-5127-12
(LB-5127-12)

45 ml, op. 12
h: 76 mm, Ø: 55 mm

PLN/EUR: 9,08 / -

49S318



ON-5121-12
(LB-5121-12)

30 ml, op. 12
h: 60 mm, Ø: 51 mm

PLN/EUR: 8,50 / -

49S318

MARTINI & MARGARITA



royal
leerdam

RL-613292-6
(LB-613445-6)

260 ml, op. 6
h: 180 mm, Ø: 108 mm

PLN/EUR: 14,81 / -

16S738



ZWIESEL
GLAS

SH-8545-86-6

343 ml, op. 6
h: 180 mm, Ø: 114 mm

PLN/EUR: 40,03 / -

9S800Y



ZWIESEL
GLAS

SH-8512-86-6

166 ml, op. 6
h: 157 mm, Ø: 101 mm

PLN/EUR: 43,16 / -

16S638



onís

ON-3779-12
(LB-3779-12)

270 ml, op. 12
h: 165 mm, Ø: 111 mm

PLN/EUR: 16,41 / -

9S638



onís

ON-3701-12
(LB-3701-12)

89 ml, op. 12
h: 97 mm, Ø: 80 mm

PLN/EUR: 14,09 / -

2S5418



ON-13080-6
155 ml, op. 6
h: 216 mm, Ø: 113 mm
PLN/EUR: 22,36 / -
 95800



ON-3658VCL60-6
(LB-925661-6)
600 ml, op. 6
h: 194 mm, Ø: 110 mm
PLN/EUR: 27,27 / -
 95800



ON-3773-36
(LB-3773-36)
163 ml, op. 36
h: 114 mm, Ø: 86 mm
PLN/EUR: 16,41 / -
 255434



SH-8512-166-6
283 ml, op. 6
h: 166 mm, Ø: 114 mm
PLN/EUR: 50,21 / -
 95638



ON-8429-12
(LB-8429-12)
270 ml, op. 12
h: 156 mm, Ø: 116 mm
PLN/EUR: 22,78 / -
 95638



ON-2934VJR75-6
750 ml, op. 6
h: 193 mm, Ø: 104 mm
PLN/EUR: 67,69 / -
 165738



ON-3715-12
(LB-3715-12)
310 ml, op. 12
h: 176 mm, Ø: 68 mm
PLN/EUR: 14,75 / -
 365738



ON-3616-6
(LB-3616-12)
445 ml, op. 6
h: 208 mm, Ø: 78 mm
PLN/EUR: 18,01 / -
 305800



ON-209-6
(LB-209-12)
475 ml, op. 6
h: 132 mm, Ø: 76 mm
PLN/EUR: 17,72 / -
 305638



ON-31042VCP32-6
335 ml, op. 6
h: 150 mm, Ø: 57 mm
PLN/EUR: 13,82 / -
 495638



NEW ERA

onís



ON-02146-6

590 ml, op. 6
h: 189 mm, Ø: 111 mm
PLN/EUR: 19,87 / -

95800

N



ON-16146-6

235 ml, op. 6
h: 157 mm, Ø: 97 mm
PLN/EUR: 19,87 / -

205638

N



ON-05146-6

220 ml, op. 6
h: 165 mm, Ø: 81 mm
PLN/EUR: 19,87 / -

255638

N



ON-14146-6

185 ml, op. 6
h: 170 mm, Ø: 98 mm
PLN/EUR: 19,87 / -

205638

N



ON-13146-6

140 ml, op. 6
h: 166 mm, Ø: 79 mm
PLN/EUR: 19,87 / -

305638

N

LEVITAS

onís



ON-31075-9400-6

345 ml, op. 6
h: 179 mm, Ø: 57 mm
PLN/EUR: 21,81 / -

495800

N



ON-37075-9400-6

200 ml, op. 6
h: 133 mm, Ø: 51 mm
PLN/EUR: 21,81 / -

495638

N



ON-33075-9400-6

355 ml, op. 6
h: 122 mm, Ø: 75 mm
PLN/EUR: 21,81 / -

305434

N



ON-35075-9400-6

265 ml, op. 6
h: 101 mm, Ø: 75 mm
PLN/EUR: 21,81 / -

305434

N



ON-02005-6
(LB-502008-12)

625 ml, op. 6
h: 212 mm, Ø: 107 mm

PLN/EUR: 19,13 / -

 165800



ON-03005-6
(LB-503005-12)

265 ml, op. 6
h: 198 mm, Ø: 90 mm

PLN/EUR: 19,13 / -

 205800



ON-14005-6
(LB-501407-12)

240 ml, op. 6
h: 161 mm, Ø: 111 mm

PLN/EUR: 19,13 / -

 95638



ON-02106-6
(LB-2106-12)

585 ml, op. 6
h: 203 mm, Ø: 103 mm

PLN/EUR: 18,71 / -

 165800



ON-03006-6
(LB-603064-12)

260 ml, op. 6
h: 194 mm, Ø: 78 mm

PLN/EUR: 18,71 / -

 305800



ON-14206-6

250 ml, op. 6
h: 161 mm, Ø: 90 mm

PLN/EUR: 18,71 / -

 205638



ON-16006-6
(LB-601602-12)

235 ml, op. 6
h: 152 mm, Ø: 97 mm

PLN/EUR: 18,84 / -

 255638



ON-14006-6
(LB-601404-12)

185 ml, op. 6
h: 164 mm, Ø: 98 mm

PLN/EUR: 18,71 / -

 205638



ON-17006-6
(LB-607017-12)

180 ml, op. 6
h: 210 mm, Ø: 72 mm

PLN/EUR: 18,84 / -

 365800



ON-13206-6
(LB-601329-12)

140 ml, op. 6
h: 160 mm, Ø: 79 mm

PLN/EUR: 18,71 / -

 305638



ON-32103-9400-6

665 ml, op. 6
h: 233 mm, Ø: 110 mm

PLN / EUR: 23,31 / -

95958



ON-33103-9400-6

410 ml, op. 6
h: 225 mm, Ø: 90 mm

PLN / EUR: 23,31 / -

205958

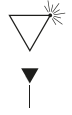

ON-46003-9400-6

280 ml, op. 6
h: 166 mm, Ø: 110 mm

PLN / EUR: 23,31 / -

95638

ON-44003-9400-6
(LB-44003-6)190 ml, op. 6
h: 196 mm, Ø: 94 mm

PLN / EUR: 24,05 / -

205800

ON-43003-9400-6
(LB-43003-6)155 ml, op. 6
h: 179 mm, Ø: 83 mm

PLN / EUR: 24,05 / -

255738

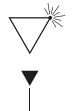

ON-46103-9400-6

120 ml, op. 6
h: 155 mm, Ø: 90 mm

PLN / EUR: 21,73 / -

205638

N



Gin tonic

ON-02041-6
(LB-02041-6)590 ml, op. 6
h: 189 mm, Ø: 111 mm

PLN / EUR: 29,90 / -

95800



Coupe

ON-16041-6
(LB-16041-6)290 ml, op. 6
h: 151 mm, Ø: 111 mm

PLN / EUR: 29,90 / -

95638



Coctail

ON-05041-6
(LB-05041-6)220 ml, op. 6
h: 166 mm, Ø: 81 mm

PLN / EUR: 29,90 / -

255638



Nick & Nora

ON-13041-6
(LB-13041-6)140 ml, op. 6
h: 172 mm, Ø: 65 mm

PLN / EUR: 29,90 / -

365638



Martini

ON-14041-6
(LB-14041-6)190 ml, op. 6
h: 176 mm, Ø: 83 mm

PLN / EUR: 29,90 / -

255738





ON-2996VCP35-12

355 ml, op. 12
h: 129 mm, Ø: 82 mm
PLN/EUR: 17,18 / -

25S434



ON-2996VCP34-12

345 ml, op. 12
h: 100 mm, Ø: 90 mm
PLN/EUR: 17,18 / -

20S434



ON-2996VCP28-12

280 ml, op. 12
h: 92 mm, Ø: 86 mm
PLN/EUR: 17,18 / -

25S418



ON-15641-12

350 ml, op. 12
h: 138 mm, Ø: 78 mm
PLN/EUR: 14,75 / -

30S638



ON-15640-12

250 ml, op. 12
h: 103 mm, Ø: 75 mm
PLN/EUR: 14,75 / -

30S434



ON-51102VCP36-12

350 ml, op. 12
h: 136 mm, Ø: 78 mm
PLN/EUR: 16,15 / -

30S638



ON-51102VCP35-12

350 ml, op. 12
h: 94 mm, Ø: 91 mm
PLN/EUR: 16,15 / -

20S434



ON-51102VCP26-12

260 ml, op. 12
h: 85 mm, Ø: 82 mm
PLN/EUR: 14,49 / -

25S318





ON-2980VCP41-6

410 ml, op. 6
h: 136 mm, Ø: 83 mm

PLN/EUR: 14,75 / -

25S534

N



ON-2979VCP41-6

410 ml, op. 6
h: 136 mm, Ø: 83 mm

PLN/EUR: 14,75 / -

25S534

N



ON-2976VCP32-6

325 ml, op. 6
h: 94 mm, Ø: 91 mm

PLN/EUR: 14,75 / -

20S434

N



ON-2977VCP35-6

350 ml, op. 6
h: 94 mm, Ø: 91 mm

PLN/EUR: 14,75 / -

20S434

N

ON-5636-6
(LB-927535-12)475 ml, op. 6
h: 157 mm, Ø: 84 mm

PLN/EUR: 22,02 / -

25S638

ON-5635-6
(LB-927542-12)355 ml, op. 6
h: 106 mm, Ø: 89 mm

PLN/EUR: 22,02 / -

25S418

ON-2970VCP35-6
(LB-826609-12)355 ml, op. 6
h: 148 mm, Ø: 68 mm

PLN/EUR: 22,58 / -

36S534



ON-2970VCP36-6

355 ml, op. 6
h: 89 mm, Ø: 87 mm

PLN/EUR: 21,65 / -

25S318

N

ON-2970VCP29-6
(LB-826982-12)290 ml, op. 6
h: 85 mm, Ø: 80 mm

PLN/EUR: 23,82 / -

25S318

TIKI

onix



ON-31079VCP47-6

475 ml, op. 6
h: 172 mm, Ø: 68 mm

PLN/EUR: 19,21 / -

365638

N

ON-92143-12
(LB-92143-12)

591 ml, op. 12
h: 169 mm, Ø: 80 mm

PLN/EUR: 19,22 / -

255638

ON-92142-12
(LB-92142-12)

473 ml, op. 12
h: 118 mm, Ø: 89 mm

PLN/EUR: 17,47 / -

205434

ON-56880-12
(LB-56880-12)

505 ml, op. 12
h: 140 mm, Ø: 80 mm

PLN/EUR: 23,17 / -

255534



BPR-029

475 ml
h: 198 mm

PLN/EUR: 218,59 / -

BAR
PROFESSIONAL

STARLA

royal
leerdam

Hi-ball

RL-2939VCP37-6
(LB-2939VCP37-6)

360 ml, op. 6
h: 143 mm, Ø: 74 mm

PLN/EUR: 12,03 / -

305638



DOF

RL-2939VCP35-6
(LB-2939VCP35-6)

350 ml, op. 6
h: 105 mm, Ø: 83 mm

PLN/EUR: 12,03 / -

255418

COLORED HOBSTAR

onix



Hobstar ocher

ON-300161-6

355 ml, op. 6
h: 106 mm, Ø: 89 mm

PLN/EUR: 22,02 / -

205434

N



Hobstar Blue

ON-829297-6
(LB-829297-6)

355 ml, op. 6
h: 106 mm, Ø: 89 mm

PLN/EUR: 22,17 / -

205434



Hobstar Grey

ON-829303-6
(LB-829303-6)

355 ml, op. 6
h: 106 mm, Ø: 89 mm

PLN/EUR: 22,17 / -

205434



Hobstar Rose

ON-829310-6
(LB-829310-6)

355 ml, op. 6
h: 106 mm, Ø: 89 mm

PLN/EUR: 22,17 / -

205434

KUP ON-LINE



COLORED HOBSTAR

onís



ON-2651VCP47-6
475 ml, op. 6
h: 156 mm, Ø: 83 mm
PLN/EUR: 29,39 / -
📦 255638

N



ON-2651VCP35-6
355 ml, op. 6
h: 106 mm, Ø: 89 mm
PLN/EUR: 25,87 / -
📦 205434

N

HOBSTAR

onís



ON-5633-6
(LB-911381-12)
475 ml, op. 6
h: 156 mm, Ø: 83 mm
PLN/EUR: 22,02 / -
📦 255638



ON-00302-6
355 ml, op. 6
h: 144 mm, Ø: 78 mm
PLN/EUR: 19,54 / -
📦 305638

N



ON-5632-6
(LB-924152-12)
355 ml, op. 6
h: 106 mm, Ø: 89 mm
PLN/EUR: 22,02 / -
📦 205434



ON-00301-12
(LB-926835-24)
60 ml, op. 12
h: 61 mm, Ø: 50 mm
PLN/EUR: 12,98 / -
📦 495318



ON-2651VCL30-6
(LB-928549-12)
300 ml, op. 6
h: 180 mm, Ø: 89 mm
PLN/EUR: 22,02 / -
📦 205800



ON-2651VCL25-6
(LB-929799-12)
250 ml, op. 6
h: 121 mm, Ø: 104 mm
PLN/EUR: 22,02 / -
📦 165434





ON-2711VCP41-6
(LB-926774-12)

415 ml, op. 6
h: 154 mm, Ø: 78 mm
PLN / EUR: 22,02 / -

305638



ON-2711VCP35-6
(LB-925500-12)

355 ml, op. 6
h: 107 mm, Ø: 89 mm
PLN / EUR: 22,02 / -

205434



ON-2711VJR75-6
(LB-926781-6)

750 ml, op. 6
h: 178 mm, Ø: 105 mm
PLN / EUR: 67,03 / -

165738



ON-2901VCP34-12
(LB-827125-12)

350 ml, op. 12
h: 96 mm, Ø: 89 mm
PLN / EUR: 20,32 / -

205434



ON-15457-12
(LB-15457-12)

295 ml, op. 12
h: 90 mm, Ø: 83 mm
PLN / EUR: 20,32 / -

255318



ON-15456-36
(LB-15456-36)

250 ml, op. 36
h: 122 mm, Ø: 69 mm
PLN / EUR: 16,59 / -

365434



ON-15465-36
(LB-15465-36)

310 ml, op. 36
h: 150 mm, Ø: 83 mm
PLN / EUR: 19,45 / -

255534



ON-15464-36
(LB-15464-36)

250 ml, op. 36
h: 141 mm, Ø: 75 mm
PLN / EUR: 17,69 / -

305638



ON-21005VCP35-6

350 ml, op. 6
h: 101 mm, Ø: 90 mm
PLN / EUR: 8,86 / -

205434



ON-21005VCP32-6

325 ml, op. 6
h: 135 mm, Ø: 77 mm
PLN / EUR: 8,86 / -

305638



ON-21005VCP21-6

215 ml, op. 6
h: 87 mm, Ø: 77 mm
PLN / EUR: 8,16 / -

305318





ON-15242-12
(LB-15242-12)

265 ml, op. 12
h: 90 mm, Ø: 86 mm

PLN / EUR: 7,01 / -

255418



ON-15240-12
(LB-15240-12)

230 ml, op. 12
h: 90 mm, Ø: 86 mm

PLN / EUR: 7,01 / -

255418



ON-151-48
(LB-151-48)

30 ml, op. 48
h: 54 mm, Ø: 46 mm

PLN / EUR: 4,71 / -

495318



ON-15247-36
(LB-15247-36)

340 ml, op. 36
h: 175 mm, Ø: 92 mm

PLN / EUR: 14,82 / -

205800



ON-15256-12
(LB-15256-12)

475 ml, op. 12
h: 162 mm, Ø: 87 mm

PLN / EUR: 10,29 / -

205638



ON-15235-12
(LB-15235-12)

355 ml, op. 12
h: 146 mm, Ø: 80 mm

PLN / EUR: 8,16 / -

255534



ON-15383-12
(LB-15383-12)

310 ml, op. 12
h: 140 mm, Ø: 75 mm

PLN / EUR: 8,69 / -

305638



ON-15237-12
(LB-15237-12)

295 ml, op. 12
h: 118 mm, Ø: 79 mm

PLN / EUR: 8,69 / -

305434



ON-15239-12
(LB-15239-12)

200 ml, op. 12
h: 115 mm, Ø: 67 mm

PLN / EUR: 8,16 / -

365434



ON-15232-12
(LB-15232-12)

290 ml, op. 12
h: 96 mm, Ø: 88 mm

PLN / EUR: 7,64 / -

205434



RAYO



RL-590012-6
(LB-829501-6)

360 ml, op. 6
h: 129 mm, Ø: 83,5 mm

PLN/EUR: 10,71 / -

255434



RL-829495-6
(LB-829495-6)

320 ml, op. 6
h: 105 mm, Ø: 84 mm

PLN/EUR: 10,71 / -

255418



RL-590036-6
(LB-829488-6)

266 ml, op. 6
h: 84 mm, Ø: 85,5 mm

PLN/EUR: 10,71 / -

255318



STARK



ON-3789VCP35-6

350 ml, op. 6
h: 162 mm, Ø: 62 mm

PLN/EUR: 11,76 / -

365638



ON-3789VCP36-6

350 ml, op. 6
h: 98 mm, Ø: 84 mm

PLN/EUR: 11,76 / -

245418



ON-3789VCP25-6

255 ml, op. 6
h: 136 mm, Ø: 58 mm

PLN/EUR: 11,76 / -

495638



ON-3789VCP28-6

285 ml, op. 6
h: 92 mm, Ø: 79 mm

PLN/EUR: 11,76 / -

305434



CIDRA



ON-3282VCP55-6
(LB-820690-12)

560 ml, op. 6
h: 121 mm, Ø: 91 mm

PLN/EUR: 9,15 / -

205434



ON-3282VCP37-6
(LB-920185-12)

390 ml, op. 6
h: 90 mm, Ø: 87 mm

PLN/EUR: 8,65 / -

255318



ON-3282VCP22-6
(LB-920192-12)

220 ml, op. 6
h: 60 mm, Ø: 83 mm

PLN/EUR: 8,80 / -

255318



KUP ON-LINE

BLISS

onís



ON-3709VCP32-6

320 ml, op. 6
h: 135 mm, Ø: 66 mm

PLN / EUR: 9,94 / -

365534

N



ON-3709VCP35-6

360 ml, op. 6
h: 98 mm, Ø: 78 mm

PLN / EUR: 10,28 / -

305434

N



ON-3709VCP30-6

305 ml, op. 6
h: 85 mm, Ø: 77 mm

PLN / EUR: 9,94 / -

305318

N

BAR

onís



ON-3237VCP28-6

290 ml, op. 6
h: 112 mm, Ø: 70 mm

PLN / EUR: 5,84 / -

365434

N



ON-3237VCP20-6

210 ml, op. 6
h: 101 mm, Ø: 65 mm

PLN / EUR: 4,84 / -

365418

N



ON-3898VCP38-6

385 ml, op. 6
h: 137 mm, Ø: 77 mm

PLN / EUR: 7,91 / -

305638

N

CHEERS

onís

ON-2060VCP34-6
(LB-921182-6)350 ml, op. 6
h: 96 mm, Ø: 91 mm

PLN / EUR: 13,90 / -

205434

ON-2060VCP33-6
(LB-929730-6)350 ml, op. 6
h: 154 mm, Ø: 75 mm

PLN / EUR: 13,90 / -

305638

IVERNESS

onís



XTRATUFF

ON-15483-12
(LB-15483-12)340 ml, op. 12
h: 144 mm, Ø: 81 mm

PLN / EUR: 15,36 / -

255534



XTRATUFF

ON-15481-12
(LB-15481-12)260 ml, op. 12
h: 89 mm, Ø: 86 mm

PLN / EUR: 14,39 / -

255318





ON-3482VCP35-12
(LB-920734-12)
360 ml, op. 12
h: 162 mm, Ø: 67 mm
PLN/EUR: 11,76 / -
 365638



ON-3482VCP29-12
(LB-920727-12)
300 ml, op. 12
h: 147 mm, Ø: 64 mm
PLN/EUR: 11,76 / -
 365534



ON-3482VCP28-12
(LB-920703-12)
280 ml, op. 12
h: 95 mm, Ø: 78 mm
PLN/EUR: 11,76 / -
 305434



ON-3482VCP21-12
(LB-920758-12)
220 ml, op. 12
h: 90 mm, Ø: 72 mm
PLN/EUR: 11,88 / -
 365318



ON-2518-12
(LB-2518-12)
320 ml, op. 12
h: 166 mm, Ø: 60 mm
PLN/EUR: 4,96 / -
 495638



ON-2524-12
(LB-2524-12)
310 ml, op. 12
h: 92 mm, Ø: 80 mm
PLN/EUR: 4,73 / -
 255418



ON-2519-12
(LB-2519-12)
295 ml, op. 12
h: 144 mm, Ø: 63 mm
PLN/EUR: 4,96 / -
 365534



ON-2520-12
(LB-2520-12)
230 ml, op. 12
h: 130 mm, Ø: 58 mm
PLN/EUR: 4,13 / -
 495434



ON-2521-12
(LB-2521-12)
225 ml, op. 12
h: 150 mm, Ø: 53 mm
PLN/EUR: 3,93 / -
 495638



ON-2522-12
(LB-2522-12)
210 ml, op. 12
h: 85 mm, Ø: 71 mm
PLN/EUR: 4,43 / -
 365318



ON-2523-12
(LB-2523-12)
155 ml, op. 12
h: 100 mm, Ø: 54 mm
PLN/EUR: 3,94 / -
 495434



ON-1650-12
(LB-1650-12)
75 ml, op. 12
h: 105 mm, Ø: 40 mm
PLN/EUR: 4,36 / -
 495434





ON-15711-12
(LB-15711-12)
295 ml, op. 12
h: 158 mm, Ø: 70 mm
PLN/EUR: 9,05 / -
 365638



ON-15710-12
(LB-15710-12)
265 ml, op. 12
h: 97 mm, Ø: 89 mm
PLN/EUR: 8,16 / -
 205318



ON-15709-12
(LB-15709-12)
200 ml, op. 12
h: 92 mm, Ø: 82 mm
PLN/EUR: 8,16 / -
 255318



ON-15733-12
(LB-15733-12)
110 ml, op. 12
h: 76 mm, Ø: 69 mm
PLN/EUR: 7,96 / -
 365318



ON-2045VCP23-6 N
235 ml, op. 6
h: 149 mm, Ø: 60 mm
PLN/EUR: 7,29 / -
 495638



ON-2045VCP30-6 N
300 ml, op. 6
h: 96 mm, Ø: 80 mm
PLN/EUR: 8,25 / -
 255418



ON-15436-12
(LB-15436-12)
355 ml, op. 12
h: 115 mm, Ø: 83 mm
PLN/EUR: 15,53 / -
 255434



ON-15435-12
(LB-15435-12)
355 ml, op. 12
h: 94 mm, Ø: 92 mm
PLN/EUR: 15,53 / -
 205434



ON-15430-12
(LB-15430-12)
265 ml, op. 12
h: 115 mm, Ø: 75 mm
PLN/EUR: 15,93 / -
 305434



ON-15433-12
(LB-15433-12)
235 ml, op. 12
h: 79 mm, Ø: 81 mm
PLN/EUR: 13,38 / -
 255318



ON-15432-12
(LB-15432-12)
205 ml, op. 12
h: 78 mm, Ø: 78 mm
PLN/EUR: 13,38 / -
 305318





ON-3010-12
(LB-3010-12)
414 ml, op. 12
h: 165 mm, Ø: 86 mm
PLN/EUR: 17,47 / -
 255638



ON-231-12
(LB-231-12)
450 ml, op. 12
h: 115 mm, Ø: 89 mm
PLN/EUR: 10,04 / -
 205434



RL-834277-6
(LB-925241-6)
330 ml, op. 6
h: 99 mm, Ø: 84 mm
PLN/EUR: 8,10 / -
 255418



ON-31080VCP60-6
600 ml, op. 6
h: 207 mm, Ø: 90 mm
PLN/EUR: 13,30 / -
 205800



ON-31080VCL41-6
420 ml, op. 6
h: 203 mm, Ø: 98 mm
PLN/EUR: 14,49 / -
 205800



ON-31080VCL32-6
325 ml, op. 6
h: 189 mm, Ø: 89 mm
PLN/EUR: 13,62 / -
 205800



ON-3713VCL49-6
505 ml, op. 6
h: 201 mm, Ø: 95 mm
PLN/EUR: 12,68 / -
 205800



ON-3713VCL37-6
370 ml, op. 6
h: 182 mm, Ø: 86 mm
PLN/EUR: 11,89 / -
 255738





ON-3924VCP68-6
680 ml, op. 6
h: 224 mm, Ø: 92 mm
PLN/EUR: 16,81 / -
📦 20S958



ON-3663VCP57-6
585 ml, op. 6
h: 191 mm, Ø: 84 mm
PLN/EUR: 19,42 / -
📦 25S738



ON-3616VCP57-6
585 ml, op. 6
h: 160 mm, Ø: 86 mm
PLN/EUR: 16,17 / -
📦 25S638



ON-21003VCN64-6
640 ml, op. 6
h: 159 mm, Ø: 134 mm
PLN/EUR: 13,82 / -
📦 9S638



ON-2384VCN56-6
575 ml, op. 6
h: 178 mm, Ø: 123 mm
PLN/EUR: 17,14 / -
📦 9S800



ON-5355-24
(LB-5355-24)
570 ml, op. 24
h: 124 mm, Ø: 137 mm
PLN/EUR: 20,54 / -
📦 9S434



ON-2187VCN55-6
550 ml, op. 6
h: 124 mm, Ø: 135 mm
PLN/EUR: 12,16 / -
📦 9S434



ON-2329VCN50-6
(LB-920260-6)
520 ml, op. 6
h: 157 mm, Ø: 123 mm
PLN/EUR: 14,96 / -
📦 9S638



ON-2130VCN32-6
320 ml, op. 6
h: 122 mm, Ø: 71 mm
PLN/EUR: 13,71 / -
📦 36S434



ON-3313VCL57-6
570 ml, op. 6
h: 190 mm, Ø: 94 mm
PLN/EUR: 15,25 / -
📦 20S800



ON-920284-6
(LB-920284-12)
490 ml, op. 6
h: 199 mm, Ø: 86 mm
PLN/EUR: 13,41 / -
📦 25S800



ON-920291-6
(LB-920291-12)
400 ml, op. 6
h: 180 mm, Ø: 81 mm
PLN/EUR: 12,42 / -
📦 25S738





ZWIESEL
GLAS

SH-8512-32-6
344 ml, op. 6
h: 163 mm, Ø: 76 mm
PLN/EUR: 35,58 / -
 305638



ZWIESEL
GLAS

SH-8730-04L-6
513 ml, op. 6
h: 191 mm, Ø: 81 mm
PLN/EUR: 44,75 / -
 255738





ZWIESEL
GLAS

SH-8730-03L-6
405 ml, op. 6
h: 178 mm, Ø: 77 mm
PLN/EUR: 41,43 / -
 305800



ZWIESEL
GLAS

SH-8710-05-6
711 ml, op. 6
h: 255 mm, Ø: 85 mm
PLN/EUR: 35,44 / -
 255958



ZWIESEL
GLAS

SH-8710-03-6
451 ml, op. 6
h: 217 mm, Ø: 73 mm
PLN/EUR: 29,73 / -
 365800



ZWIESEL
GLAS

SH-8720-05L-6
678 ml, op. 6
h: 204 mm, Ø: 88 mm
PLN/EUR: 35,44 / -
 205800



ZWIESEL
GLAS

SH-8720-06L-6
602 ml, op. 6
h: 157 mm, Ø: 89 mm
PLN/EUR: 35,44 / -
 205638





ON-97084-12
(LB-97084-12)

490 ml, op. 12
h: 133 mm, Ø: 107 mm

PLN/EUR: 30,72 / -

165534



ON-2711VCP41-6
(LB-926774-12)

415 ml, op. 6
h: 154 mm, Ø: 78 mm

PLN/EUR: 22,02 / -

305638



ON-5633-6
(LB-911381-12)

475 ml, op. 6
h: 156 mm, Ø: 83 mm

PLN/EUR: 22,02 / -

255638



ON-5636-6
(LB-927535-12)

475 ml, op. 6
h: 157 mm, Ø: 84 mm

PLN/EUR: 22,02 / -

255638



ON-209-6
(LB-209-12)

475 ml, op. 6
h: 132 mm, Ø: 76 mm

PLN/EUR: 17,72 / -

305638



ON-56880-12
(LB-56880-12)

505 ml, op. 12
h: 140 mm, Ø: 80 mm

PLN/EUR: 23,17 / -

255534



BAR
PROFESSIONAL

BPR-029

475 ml
h: 198 mm

PLN/EUR: 218,59 / -



BAR
PROFESSIONAL

BPR-M450

450 ml, op.
h: 100 mm, Ø: 85 mm

PLN/EUR: 60,61 / -

TULIPA

ONIS

GALÃO

ONIS



ON-2002VCP14-6

145 ml, op. 6
h: 78 mm, Ø: 68 mm

PLN/EUR: 10,18 / -

365318

N



ON-2004VCP10-12
(LB-923285-24)

100 ml, op. 12
h: 84 mm, Ø: 55 mm

PLN/EUR: 9,22 / -

495318



ON-2004VCP22-6
(LB-923278-12)

220 ml, op. 6
h: 106 mm, Ø: 73 mm

PLN/EUR: 11,73 / -

305434



ON-21066VCH08-12

80 ml, op. 12
h: 75 mm, Ø: 75 mm

PLN/EUR: 8,74 / -

305318



ON-21066VCN22-6

220 ml, op. 6
h: 89 mm, Ø: 108 mm

PLN/EUR: 10,40 / -

165318



ON-21066VCN26-6

260 ml, op. 6
h: 143 mm, Ø: 111 mm

PLN/EUR: 12,16 / -

95638



ON-21066VCN37-6

370 ml, op. 6
h: 111 mm, Ø: 126 mm

PLN/EUR: 12,16 / -

95434



ON-15733-12
(LB-15733-12)

110 ml, op. 12
h: 76 mm, Ø: 69 mm

PLN/EUR: 7,96 / -

365318



ON-2264VCN12-6
(LB-2264FCN-12)

120 ml, op. 6
h: 110 mm, Ø: 83 mm

PLN/EUR: 9,56 / -

255434



ON-2264VCN24-6
(LB-920338-12)

225 ml, op. 6
h: 146 mm, Ø: 104 mm

PLN/EUR: 10,14 / -

165534



ON-2291VCN24-6

225 ml, op. 6
h: 147 mm, Ø: 104 mm

PLN/EUR: 9,96 / -

165534



ON-2302VCN28-6
(LB-920314-12)

285 ml, op. 6
h: 150 mm, Ø: 78 mm

PLN/EUR: 9,48 / -

305638



ON-21106VTC35-6

350 ml, op. 6
h: 189 mm, Ø: 83 mm

PLN/EUR: 15,53 / -

255738



ON-2783VCH08-12

80 ml, op. 12
h: 65 mm, Ø: 59 mm

PLN/EUR: 8,88 / -

365318



ON-2609VCN18-6

180 ml, op. 6
h: 81 mm, Ø: 75 mm

PLN/EUR: 9,36 / -

305318



ON-15711-12
(LB-15711-12)

295 ml, op. 12
h: 158 mm, Ø: 70 mm

PLN/EUR: 9,05 / -

365638



R-CLSA01-12

op. 12
Ø: 157 mm

PLN/EUR: 17,55 / -



E-2111731-12

PLN/EUR: 10,35 / -





ON-2262VTC38-6
(LB-920550-12)

380 ml, op. 6
h: 118 mm, Ø: 115 mm

PLN/EUR: 12,16 / -

95434



ON-15247-36
(LB-15247-36)

340 ml, op. 36
h: 175 mm, Ø: 92 mm

PLN/EUR: 14,82 / -

205638



ON-2233VTC28-6
(LB-922073-12)

280 ml, op. 6
h: 86 mm, Ø: 108 mm

PLN/EUR: 12,16 / -

165318



ON-2651VCL25-6
(LB-929799-12)

250 ml, op. 6
h: 121 mm, Ø: 104 mm

PLN/EUR: 22,02 / -

165434



ON-2721VTC24-6

245 ml, op. 6
h: 146 mm, Ø: 130 mm

PLN/EUR: 15,30 / -

95638



DZBANKI / JUGS



ON-5260-6
(LB-5260-6)

1770 ml, op. 6
h: 234 mm, Ø: 180 mm

PLN/EUR: 36,46 / -



ON-3886-6
(LB-1792421-6)

1000 ml, op. 6
h: 197 mm, Ø: 168 mm

PLN/EUR: 30,38 / -

BUTELKI I KAPSLOWNIK / BOTTLE / CAP SET



kapslownik

C1-1074

PLN/EUR: 96,60 / -



100%Chef

butelki 200 ml

C1-1073

200 ml, op. 24
h: 180 mm, Ø: 50 mm

PLN/EUR: 113,32 / -



100%Chef

kapsle złote

C1-1075

op. 100
PLN/EUR: 36,91 / -



BAR
PROFESSIONAL

Dziurkacz do kapsli

BPR-018

PLN/EUR: 80,37 / -



KARAFKI / DECANTERS



ON-795-12
(LB-795-12)

1183 ml, op. 12
h: 273 mm, Ø: 95 mm
PLN/EUR: 42,76 / -

20S1114



ON-97001-12
(LB-97001-12)

500 ml, op. 12
h: 213 mm, Ø: 79 mm
PLN/EUR: 18,23 / -

30S800



RL-834413-6
(LB-927634-12)

1070 ml, op. 6
h: 250 mm, Ø: 100 mm
PLN/EUR: 19,45 / -

16S958



RL-834406-6
(LB-927467-6)

740 ml, op. 6
h: 240 mm, Ø: 89 mm
PLN/EUR: 14,60 / -

20S958

BUTELKI WECK / WECK BOTTLES



Butelka

WE-763-60

290 ml, op. 6
h: 140 mm, Ø: 60 mm
PLN/EUR: 37,11 / -



Butelka

WE-764-60

530 ml, op. 6
h: 184 mm, Ø: 60 mm
PLN/EUR: 40,28 / -



Butelka

WE-766-60

1062 ml, op. 6
h: 250 mm, Ø: 60 mm
PLN/EUR: 59,49 / -



Butelka, komplet*

WE-763-60PUZ

290 ml, op. 6
h: 149 mm, Ø: 60 mm
PLN/EUR: 66,45 / -



Butelka, komplet*

WE-764-60PUZ

530 ml, op. 6
h: 193 mm, Ø: 60 mm
PLN/EUR: 69,61 / -



Butelka, komplet*

WE-766-60PUZ

1062 ml, op. 6
h: 259 mm, Ø: 60 mm
PLN/EUR: 85,84 / -

KUP ON-LINE



* – Komplet zawiera: pokrywkę, uszczelkę, 2 zapinki | Set includes: lid, seal, 2 clasps

**MB-20S**200 ml
h: 88 mm, Ø: 80 mm

PLN/EUR: 6,53 / -

25S318

**MB-45S**500 ml
h: 106 mm, Ø: 90 mm

PLN/EUR: 10,37 / -

20S434

**MB-45B**500 ml
h: 106 mm, Ø: 90 mm

PLN/EUR: 10,56 / -

20S434

**MB-45W**500 ml
h: 106 mm, Ø: 90 mm

PLN/EUR: 10,56 / -

20S434



DZBANKI Z POLIWĘGLANU / POLYCARBONATE



CAMBRO

CM-P320CW

950 ml
h: 170 mm, Ø: 145 mm
PLN / EUR: 54,72 / -



CAMBRO

CM-P34CW

1000 ml
h: 170 mm, Ø: 170 mm
PLN / EUR: 21,66 / -



CAMBRO

CM-PC64CW

1900 ml
h: 248 mm, Ø: 185 mm
PLN / EUR: 91,11 / -



CAMBRO

Pokrywka / Cover

CM-P34LCW

PLN / EUR: 9,83 / -

DZBANKI Z POLIPROPYLENU / POLYPROPYLENE JUGS



Blim

N

Dzbanek; polipropylen
Jug; polypropylene

Nr kat.	Ø cm	h cm	cap l	col	PLN	EUR
○ BP-CF4-000	11	24	1,7	krystaliczny biały	80,49	-
● BP-CF4-010	11	24	1,7	karbon	80,49	-
● BP-CF4-314	11	24	1,7	leśny średni	80,49	-
● BP-CF4-319	11	24	1,7	mokka	80,49	-
● BP-CF4-335	11	24	1,7	morela	80,49	-
● BP-CF4-336	11	24	1,7	cukier trzcinowy	80,49	-

KUP ON-LINE



KOSZE DO SZKŁA / GLASS RACKS



MAX ø 60 mm
49 przedziałów



MAX ø 72 mm
36 przedziałów



MAX ø 79 mm
30 przedziałów

max. h mm	Nr kat.	PLN	EUR	Nr kat.	PLN	EUR	Nr kat.	PLN	EUR
90	CM-49S318	137,94	-	CM-36S318	123,69	-	CM-30S318	123,40	-
110	—	—	—	CM-36S418	130,53	-	—	—	—
132	CM-49S434	194,75	-	CM-36S434	166,44	-	CM-30S434	166,15	-
152	—	—	—	CM-36S534	173,00	-	—	—	—
174	CM-49S638	251,56	-	CM-36S638	209,19	-	CM-30S638	208,90	-
194	—	—	—	CM-36S738	215,75	-	—	—	—
216	CM-49S800	308,37	-	CM-36S800	251,94	-	CM-30S800	251,65	-
238	—	—	—	CM-36S900	258,50	-	—	—	—
258	CM-49S958	365,15	-	CM-36S958	294,69	-	CM-30S958	294,40	-
278	—	—	—	CM-36S1058	301,25	-	—	—	—
300	CM-49S1114	421,99	-	CM-36S1114	337,44	-	CM-30S1114	337,15	-
320	—	—	—	CM-36S1214	344,00	-	—	—	—



MAX ø 87 mm
25 przedziałów



MAX ø 98 mm
20 przedziałów

max. h mm	Nr kat.	PLN	EUR	Nr kat.	PLN	EUR
90	CM-25S318	120,94	-	CM-20S318	120,94	-
110	CM-25S418	124,54	-	—	—	—
132	CM-25S434	161,50	-	CM-20S434	161,50	-
152	CM-25S534	164,92	-	—	—	—
174	CM-25S638	202,06	-	CM-20S638	202,06	-
194	CM-25S738	205,49	-	—	—	—
216	CM-25S800	242,63	-	CM-20S800	242,63	-
238	CM-25S900	246,05	-	—	—	—
258	CM-25S958	283,19	-	CM-20S958	283,19	-
278	CM-25S1058	286,62	-	—	—	—
300	CM-25S1114	323,76	-	CM-20S1114	323,76	-
320	CM-25S1214	327,18	-	—	—	—



MAX ø 109 mm
16 przedziałów



MAX ø 148 mm
9 przedziałów

max. h mm	Nr kat.	PLN	EUR	Nr kat.	PLN	EUR
90	CM-16S318	120,46	-	CM-9S318	118,37	-
110	CM-16S418	124,54	-	—	—	—
132	CM-16S434	159,79	-	CM-9S434	156,65	-
152	CM-16S534	163,78	-	—	—	—
174	CM-16S638	199,12	-	CM-9S638	194,94	-
194	CM-16S738	203,11	-	—	—	—
216	CM-16S800	238,45	-	CM-9S800	233,22	-
238	CM-16S900	242,44	-	—	—	—
258	CM-16S958	277,78	-	CM-9S958	271,51	-
278	CM-16S1058	281,77	-	—	—	—
300	CM-16S1114	324,11	-	CM-9S1114	309,80	-
320	CM-16S1214	321,10	-	—	—	—

Dopasowanie kieliszków do koszy

*Matching your glasses
with the dishrack*

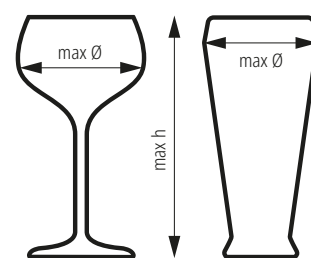

Zmierz średnicę w najszerszym miejscu
oraz maksymalną wysokość

*Measure the maximum diameter
and the maximum height of your glass*

Podstawowe kolory koszy:

Basic glass racks colors:

	zielony	119
	czerwony	163
	granatowy	186
	brązowy	167
	czarny	110
	jasny szary	151
	beżowy	184
	zielono-niebieski	414





Pokrywa; PP
Cover; PP

Nr kat.	l cm	h cm	w cm	PLN	EUR
CM-DRC2020	50	2,4	50	94,19	-



Wózek; PP
Cart; PP

Nr kat.	l cm	w cm	PLN	EUR
CM-CDR2020	53	53	616,17	-



Kosz z bolcami; PP
Rack with pins; PP

Nr kat.	l cm	h cm	w cm	PLN	EUR
CM-PR59314	50	10,1	50	85,64	-



Kosz z bolcami, wysoki; PP
High rack with pins; PP

Nr kat.	l cm	h cm	w cm	PLN	EUR
CM-PR59500	50	14,3	50	187,06	-



Kosz na tace; PP
Rack for trays; PP

Nr kat.	l cm	h cm	w cm	PLN	EUR
CM-OETR314	50	10,1	50	131,39	-



Kosz do zmywarki; PP
Dishwashing rack; PP

Nr kat.	l cm	h cm	w cm	col	PLN	EUR
CM-FR258151	50	10,1	50	szary	81,94	-



Kosz do mycia sztućców; PP
Rack for cutlery; PP

Nr kat.	l cm	h cm	w cm	PLN	EUR
CM-8FBNH434151	45	18,4	25,4	110,68	-



Kosz do mycia sztućców; PP
Rack for cutlery; PP

Nr kat.	l cm	h cm	w cm	PLN	EUR
CM-8FB434	50	18,4	25,4	188,48	-



PEUGEOT to jedna z najbardziej rozpoznawalnych francuskich marek. Młynki Peugeot pojawiają się na stołach restauracji najslawniejszych szefów kuchni, a historia stojąca za nimi jest niezwykła. Peugeot prezentuje harmonijną kolekcję inspirującego designu i technologii.

PEUGEOT is one of the most recognizable French brands. Peugeot grinders appear on the tables of the most famous chefs, and the story behind them is extraordinary. Peugeot presents a harmonious collection of inspiring design and technology.

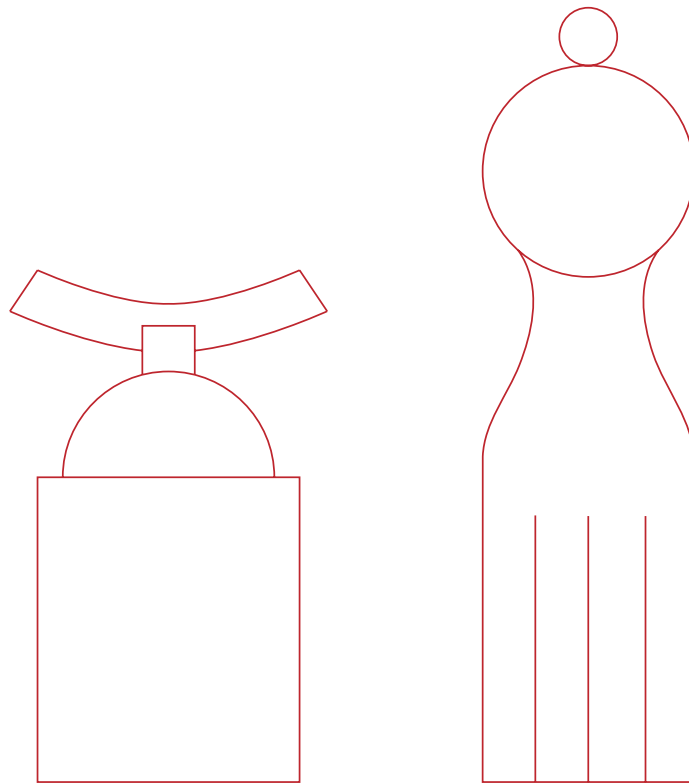

harmonia

PEUGEOT przywiązuje niezwykłą wagę do harmonii, celebrując przy tym gusta, wzmacniając smak, tak by produktami mogli cieszyć się najwięksi koneserzy degustacji.

harmony: PEUGEOT attaches great importance to harmony, celebrating and enhancing the taste in such a way that the most demanding gourmets can enjoy the products.

słono / ostro

PEUGEOT odkrywa różnorodne obszary smaku poprzez dobór wyjątkowych gatunków pieprzu i soli. Nietypowe, wyszukane, nieprzewidywalne... chcemy byś to Ty odkrywał różnorodność smaków.

salty / spicy: PEUGEOT discovers a variety of areas of taste by choosing the unique species of pepper and salt. Unusual, sophisticated, unpredictable, we want you to discover the diversity of flavors.

u>Select

Peugeot łączy w sobie tradycję z najnowszą technologią, design i ergonomię z wyjątkowym know-how. Wybrane młynki posiadają jedyny na świecie, opatentowany mechanizm szybkiej i precyzyjnej zmiany grubości mielenia u>Select.

u>Select: Peugeot combines tradition with the latest technology, design and ergonomics with unique know-how. Selected grinders have a one of a kind patented mechanism in the world for fast and precise change of grinding thickness.



Młynek Paris Nature; buk
Paris Nature mill; beech wood

Nr kat.		h cm	PLN	EUR
PG-38120	P	12	118,66	-
PG-38137	S	12	118,66	-
PG-38106	P	18	161,34	-
PG-38113	S	18	161,34	-
PG-38083	P	22	178,42	-
PG-38090	S	22	178,42	-
PG-38069	P	30	229,64	-
PG-38076	S	30	229,64	-
PG-39318	P	40	306,46	-

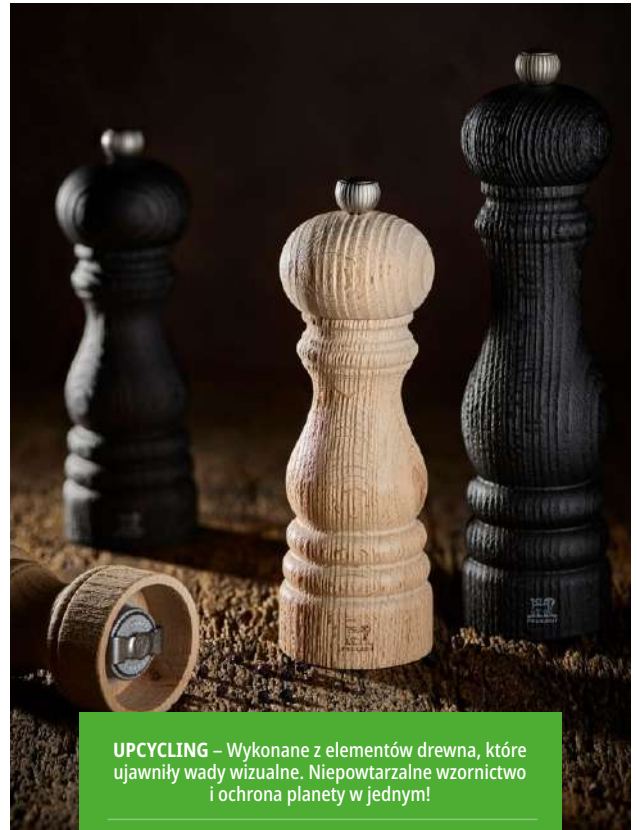

UPCYCLING – Wykonane z elementów drewna, które ujawniły wady wizualne. Niepowtarzalne wzornictwo i ochrona planety w jednym!

UPCYCLING – Made of wood elements that revealed a visual defect. Unique design and planet protection in one!



Młynek Paris Nature; buk
Paris Nature mill; beech wood

Nr kat.		h cm	PLN	EUR
PG-41380	P	12	110,12	-
PG-41397	S	12	118,66	-
PG-41403	P	18	161,34	-
PG-41410	S	18	161,34	-
PG-41427	P	22	178,42	-
PG-41434	S	22	178,42	-
PG-41441	P	30	229,64	-
PG-41458	S	30	229,64	-
PG-41465	P	40	306,46	-

KUP ON-LINE





Młynek Paris Classique; buk
Pepper mill Paris Classique; beech

Nr kat.		h cm	PLN	EUR
PG-870412-1	P	12	110,13	-
PG-870412-SME-1	S	12	110,13	-
PG-870418-1	P	18	129,30	-
PG-870418-SME-1	S	18	129,30	-
PG-870422-1	P	22	148,45	-
PG-870422-SME-1	S	22	148,45	-
PG-870430-1	P	30	201,13	-
PG-870430-SME-1	S	30	201,13	-
PG-870440-1	P	40	281,33	-
PG-870450-1	P	50	459,71	-
PG-870480-1	P	80	1 076,25	-



Młynek Paris Classique; buk
Pepper mill Paris Classique; beech

Nr kat.		h cm	PLN	EUR
PG-0870412	P	12	110,13	-
PG-0870412-SME	S	12	110,13	-
PG-0870418	P	18	129,30	-
PG-0870418-SME	S	18	129,30	-
PG-0870422	P	22	147,25	-
PG-0870422-SME	S	22	147,25	-
PG-0870430	P	30	202,32	-
PG-0870430-SME	S	30	202,32	-



Młynek Paris Antique; buk
Pepper mill Paris Antique; beech

Nr kat.		h cm	PLN	EUR
PG-30957	P	18	222,92	-
PG-30964	S	18	222,92	-
PG-30971	P	22	248,75	-
PG-30988	S	22	248,75	-



Młynek Paris Classique; buk
Pepper mill Paris Classique; beech

Nr kat.		h cm	PLN	EUR
PG-1870412	P	12	110,13	-
PG-1870412-SME	S	12	110,13	-
PG-1870418	P	18	144,86	-
PG-1870418-SME	S	18	144,86	-
PG-30407	P	50	537,53	-
PG-30421	P	80	1 076,25	-



Młynek Paris Chef; 18/10
Pepper mill Paris Chef; 18/10

Nr kat.		h cm	PLN	EUR
PG-32470	P	18	240,24	-
PG-32487	S	18	240,24	-
PG-32494	P	22	266,07	-
PG-32500	S	22	266,07	-
PG-32517	P	30	326,34	-
PG-32524	S	30	326,34	-

 SELECT
MOUTURE SUR MESURE

Młynek Nancy; arkyl
Pepper mill Nancy; acrylic

Nr kat.		h cm	PLN	EUR
PG-900809	P	9	111,09	-
PG-900809-SME	S	9	111,09	-
PG-900812	P	12	136,92	-
PG-900812-SME	S	12	136,92	-
PG-900818	P	18	145,95	-
PG-900818-SME	S	18	145,95	-
PG-900822	P	22	162,82	-
PG-900822-SME	S	22	162,82	-
PG-900830	P	30	248,85	-
PG-900830-SME	S	30	248,85	-
PG-900838	P	38	412,44	-
PG-900838-SME	S	38	412,44	-





Młynek Bistro Graphite; buk
Bistro Graphite mill; beech wood

Nr kat.		h cm	PLN	EUR
PG-39509	P	10	110,12	-
PG-39516	S	10	110,12	-



Młynek Bistro Nature; buk
Bistro Nature mill; beech wood

Nr kat.		h cm	PLN	EUR
PG-38144	P	10	110,12	-
PG-38151	S	10	110,12	-



Młynek Bistro Nature; buk
Bistro Nature mill; beech wood

Nr kat.		h cm	PLN	EUR
PG-41366	P	10	110,12	-
PG-41373	S	10	110,12	-



Młynek Bistro Antique; buk
Pepper mill Bistro Antique; beech

Nr kat.		h cm	PLN	EUR
PG-30933	P	10	131,69	-
PG-30940	S	10	131,69	-



Młynek Bistro; buk
Pepper mill Bistro; beech

Nr kat.		h cm	PLN	EUR
PG-22730	P	10	106,55	-
PG-24208	S	10	106,55	-



Młynek Bistro; buk
Salt mill Bistro; beech

Nr kat.		h cm	PLN	EUR
PG-22440	S	10	106,55	-
PG-24215	P	10	106,55	-



Młynek Bistro; buk
Pepper mill Bistro; beech

Nr kat.		h cm	PLN	EUR
PG-800-1	P	10	101,75	-
PG-9800-1-SME	S	10	101,75	-



Młynek Bistro; buk
Pepper mill Bistro; beech

Nr kat.		h cm	PLN	EUR
PG-22594	P	10	101,75	-
PG-22600	S	10	101,75	-



Młynek Bistro Chef; 18/10
Pepper mill Bistro Chef; 18/10

Nr kat.		h cm	PLN	EUR
PG-33033	P	10	135,27	-
PG-33040	S	10	135,27	-



Młynek Palace; mosiądz, srebro, buk
Pepper mill Palace; brass, silver, beech

Nr kat.		h cm	PLN	EUR
PG-19570	P	10	429,64	-
PG-19587	S	10	429,64	-



Młynek Mignonnette; mosiądz, srebro
Pepper mill Mignonnette; brass, silver

Nr kat.		h cm	PLN	EUR
PG-816-1	P	10	663,98	-
PG-9816-1-SME	S	10	663,98	-



BISTRORAMA



NOWE KOLORY

N

Młynek Bistrorama; buk
Bistrorama mill; beech wood

Nr kat.		h cm	PLN	EUR
● PG-40703	P	10	110,12	-
● PG-40710	S	10	110,12	-
● PG-40727	P	10	110,12	-
● PG-40734	S	10	110,12	-
● PG-40741	P	10	110,12	-
● PG-40758	S	10	110,12	-
● PG-40765	P	10	110,12	-
● PG-40772	S	10	110,12	-
● PG-40789	P	10	110,12	-
● PG-40796	S	10	110,12	-
● PG-40802	P	10	110,12	-
● PG-40819	S	10	110,12	-
● PG-40840	P	10	110,12	-
● PG-40857	S	10	110,12	-
● PG-40864	P	10	110,12	-
● PG-40871	S	10	110,12	-

Młynek Bistrorama; buk
Bistrorama mill; beech wood

Nr kat.		h cm	PLN	EUR
● PG-42080	P	10	113,01	-
● PG-42097	S	10	113,01	-
● PG-42103	P	10	113,01	-
● PG-42110	S	10	113,01	-
● PG-42066	P	10	113,01	-
● PG-42073	S	10	113,01	-
● PG-42042	P	10	113,01	-
● PG-42059	S	10	113,01	-
● PG-40826	P	10	113,01	-
● PG-40833	S	10	113,01	-

KUP ON-LINE

Młynek Baya; buk
Salt mill Baya; beech

Nr kat.		h cm	PLN	EUR
PG-27889	S	8	146,58	-

Młynek Baya; buk
Pepper mill Baya; beech

Nr kat.		h cm	PLN	EUR
PG-27896	P	8	146,58	-



Młynek Line; buk, Al
Line mill; beech wood, Al

Nr kat.		h cm	PLN	EUR
PG-39929	P	12	161,34	-
PG-39936	S	12	161,34	-



Młynek Line; buk, Al
Line mill; beech wood, Al

Nr kat.		h cm	PLN	EUR
PG-39882	P	12	161,34	-
PG-39899	S	12	161,34	-



Młynek Tahiti; buk
Pepper mill Tahiti; beech

Nr kat.		h cm	PLN	EUR
PG-18368	P	15	136,92	-
PG-18382	P	20	179,87	-



Młynek Tahiti; buk
Salt mill Tahiti; beech

Nr kat.		h cm	PLN	EUR
PG-24239	S	15	136,92	-
PG-24253	S	20	179,97	-



Młynek Fidji; buk, 18/10
Pepper mill Fidji; beech, 18/10

Nr kat.		h cm	PLN	EUR
PG-17132	P	15	197,40	-
PG-17149	S	15	197,40	-
PG-17156	P	20	248,85	-
PG-17163	S	20	248,85	-
PG-21283	P	12	154,14	-
PG-21290	S	12	154,14	-



Młynek Royan; buk
Pepper mill Royan; beech

Nr kat.		h cm	PLN	EUR
PG-33880	P	14	205,80	-
PG-33897	S	14	205,80	-



Młynek Hostellerie; buk
Pepper mill Hostellerie; beech

Nr kat.		h cm	PLN	EUR
PG-22648	P	22	146,58	-



Młynek Hostellerie; buk
Salt mill Hostellerie; beech

Nr kat.		h cm	PLN	EUR
PG-806-1	P	22	145,53	-



 SELECT
MOUTURE SUR MESURE

 Młynek Daman; akryl, 18/10
Pepper mill Daman; acrylic

Nr kat.		h cm	PLN	EUR
PG-25427	P	16	248,85	-
PG-25434	S	16	248,85	-
PG-25441	P	21	266,07	-
PG-25458	S	21	266,07	-

 Młynek Baltic; akryl
Pepper mill Baltic; acrylic

Nr kat.		h cm	PLN	EUR
PG-25762	P	8	119,68	-
PG-25779	S	8	119,68	-

 Młynek Chaumont; akryl
Pepper mill Chaumont; acrylic

Nr kat.		h cm	PLN	EUR
PG-940211	P	11	145,53	-

 Młynek do pieprzu z solniczką Pontarlier; akryl
Pepper mill with salt shaker Pontarlier; acrylic

Nr kat.		h cm	PLN	EUR
PG-860501		15	145,53	-

 Młynek Molene; akryl
Pepper mill Molene; acrylic

Nr kat.		h cm	PLN	EUR
PG-28992	P	14	145,53	-
PG-29029	S	14	145,53	-

 Młynek Molene; akryl
Pepper mill Molene; acrylic

Nr kat.		h cm	PLN	EUR
PG-29012	P	14	145,53	-
PG-29029	S	14	145,53	-

 Młynek Oléron; buk, akryl
Pepper mill Oléron; beech, acrylic

Nr kat.		h cm	PLN	EUR
PG-28404	P	14	162,75	-
PG-28411	S	14	162,75	-

 Młynek Oléron; buk, akryl
Pepper mill Oléron; beech, acrylic

Nr kat.		h cm	PLN	EUR
PG-28374	P	14	162,75	-
PG-28381	S	14	162,75	-

 Młynek Ouessant; buk, akryl
Pepper mill Ouessant; beech, acrylic

Nr kat.		h cm	PLN	EUR
PG-29036	P	14	179,97	-
PG-29043	S	14	179,97	-
PG-29050	chilli	14	205,80	-

 Młynek do gałki muszkatołowej Tidore; akryl
Nutmeg mill Tidore; acrylic

Nr kat.		h cm	PLN	EUR
PG-19501		11	171,34	-

 Mieści 7-8 gałek
Mieści 7-8 nutmegs capacity

 Młynek Vittel; akryl
Vittel mill; acrylic

Nr kat.		h cm	PLN	EUR
PG-18238	S	16	169,92	-
PG-18221	P	16	169,92	-
PG-18252	S	23	194,31	-
PG-18245	P	23	194,31	-

N





N

Młynek Oslo; akryl, stal nierdzewna
Oslo mill; acrylic, stainless steel

Nr kat.	h cm	PLN	EUR	
PG-34566	S	14	137,40	-
PG-34559	P	14	137,40	-



N

Młynek Oslo do pieprzu z solniczką; akryl, stal nierdzewna
Oslo pepper mill with salt shaker; acrylic, stainless steel

Nr kat.	h cm	PLN	EUR
PG-34542	13	161,79	-



N

Młynek Oslo do mokrej soli morskiej; akryl, stal nierdzewna
Oslo wet sea salt mill; acrylic, stainless steel

Nr kat.	h cm	PLN	EUR	
PG-34573	S	14	161,79	-



N

Nakrętka do młynków - pieprz
Knob to pepper mill

Nr kat.	col	PLN	EUR
PG-600334	postarzany	8,94	-
PG-600297	matowy złoty	8,94	-
PG-600273	błyszczący chrom	8,94	-
PG-600358	chrom mat	8,94	-
PG-600310	nikiel mat	8,94	-
PG-600372	miedziany	8,94	-
PG-600396	karbon	8,94	-



N

Nakrętka do młynków - sól
Knob to salt mill

Nr kat.	col	PLN	EUR
PG-600341	postarzany	8,94	-
PG-600303	matowy złoty	8,94	-
PG-600280	błyszczący chrom	8,94	-
PG-600365	chrom mat	8,94	-
PG-600327	nikiel mat	8,94	-
PG-600389	miedziany	8,94	-
PG-600402	karbon	8,94	-



SELECT
MOUTURE SUR MESURE

Młynek Elis Sense; 18/10
Elis Sense electric mill; 18/10

Nr kat.	col	PLN	EUR	
PG-27162	P	inox	412,44	-
PG-27179	S	inox	412,44	-

Oświetlenie potrawy w czasie pracy młynka •
Zasilane bateriami AAA

Lighting the meal while working • Batteries AAA



Podstawa do młynków Linea bois; buk, 18/10
Basis for mills Linea bois; beech, 18/10

Nr kat.	l cm	h cm	w cm	PLN	EUR
PG-25847	21	15	9	119,70	-

Max. śr. młynków: 5,6 cm

Max. dia. of mills 5,6 cm



Podstawa do młynków Linea; akryl, 18/10
Basis for mills Linea; acrylic, 18/10

Nr kat.	l cm	h cm	w cm	PLN	EUR
PG-25854	15	19	9	68,04	-

Max. śr. młynków: 6,4 cm

Max. dia. of mills 6,4 cm



BAR I KAWIARNIA

W tym dziale znajdziesz szeroki asortyment profesjonalnych sprzętów, akcesoriów i przyborów niezbędnych w każdym lokalu serwującym napoje i koktajle. Zestawy barmańskie, coolery, muddlery, shakery, korkociągi, łyżki barmańskie renomowanych marek takich jak BAR PROFESSIONAL, PEUGEOT, ABERT czy ETERNUM pozwolą stworzyć niepowtarzalne kompozycje.

PEUGEOT is one of the most recognizable French brands. Peugeot grinders appear on the tables of the most famous chefs, and the story behind them is extraordinary. Peugeot presents a harmonious collection of inspiring design and technology.

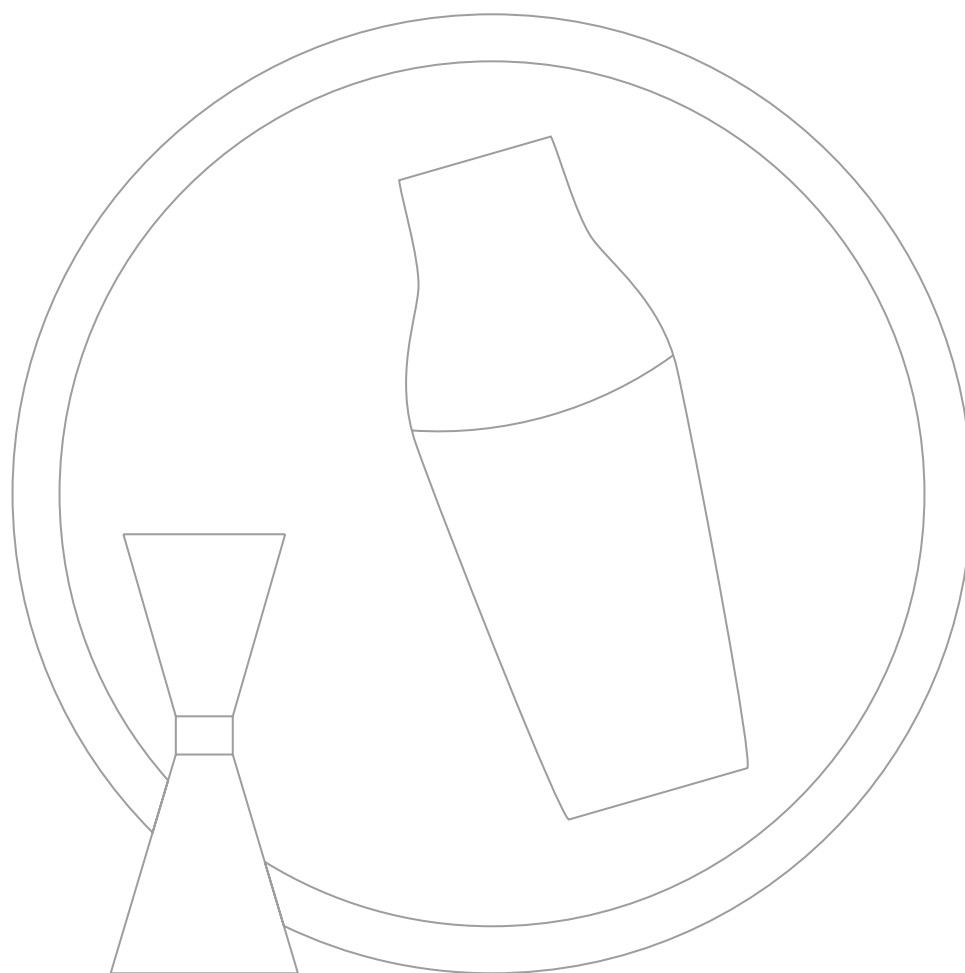

KUP ON-LINE



BarEq

BAR
PROFESSIONAL

blendtec.
THE WORLD'S MOST ADVANCED BLENDER®

on's

Verlo

RAK
PORCELAIN



Blender CONNOISSEUR 825
Blender Connoisseur 825

Nr kat.	l cm	h cm	w cm	cap l	W	obr./m	PLN	EUR
T-BT825	23	47,5	23	2,6	1800	30000	7 163,00	-

Noże zbiornika wykonane ze stali • 30 programów • Możliwość wprowadzania własnych programów z PC • Sterowanie za pomocą dotykowego panelu sterującego • Wyświetlacz w kolorze niebieskim • Wyświetlacz informuje o czasie do końca cyklu • Możliwość wbudowania w blat • Obudowa dźwiękochłonna obniżająca poziom hałasu pracy, wpływa na komfort zarówno gości, jak i użytkownika • Rekomendowana ilość napojów dziennie: 150+ • Dożywotnia gwarancja na sprzęt i noże

Tank knives made of steel • 30 programs • Possibility of insertion own programs with PC • Control via touch control panel • Blue display • The display shows the time to the end cycle • Possibility of building in the worktop • Lowering sound-absorbing housing noise level of work, affects the comfort of both guests and the user • Recommended daily blends: 150+ • Lifetime warranty on the clutch and knives



Blender EZ 600
Blender EZ 600

Nr kat.	l cm	h cm	w cm	cap l	W	obr./m	PLN	EUR
T-BT600	20,3	38,1	17,7	1,8	2200	20000	3 630,90	-

Noże zbiornika wykonane ze stali • 3 programy + tryb pulsacyjny • Membranowy panel sterujący z 4 przyciskami • Wyświetlacz w kolorze niebieskim • Wyświetlacz informuje o czasie do końca cyklu • Rekomendowana wydajność: 100-150 cykli dziennie • Dożywotnia gwarancja na sprzęt i noże

Tank knives made of steel • Program cycles: S,M,L + Pulse • Diaphragm control panel with 4 buttons • Blue display • The display informs you about the time until the end of the cycle • Recommended performance: 100-150 cycles per day • Lifetime warranty on clutch and knives



Myjka do pojemników
Washer for jugs

Nr kat.	PLN	EUR
T-BTM2	4 631,25	-



Pokrywa zapasowa; silikon
Spare lid; silicone

Nr kat.	PLN	EUR
T-BTP1	67,93	-
T-BTP2	135,85	-



Dzbanek Fourside; PC
Jug Fourside; PC

Nr kat.	cap l	PLN	EUR
T-BTJ1	1,8	1 000,42	-



Dzbanek Wildside; PC
Jug Wildside; PC

Nr kat.	cap l	PLN	EUR
T-BTJ2	2,6	1 117,68	-





COLD PRESS

Opatentowany system tłoczenia na zimno, dzięki któremu można wyciskać soki z wszelkiego rodzaju owoców, warzyw, wraz z zachowaniem witamin, enzymów i składników odżywczych.

Patented cold pressing system allows to squeeze juices from all kinds of fruits, vegetables, while preserving vitamins, enzymes and nutrients.



Wyciskarka wolnoobrotowa Cold Press
Cold Fresh juicer

Nr kat.	l cm	h cm	w cm	W	kg	PLN	EUR
T-S65	41,2	64	23,3	400	28,6	18 166,79	-

Bardzo wysoka wydajność do 60 l/h. Duży otwór wlotowy 79 mm pozwala na swobodne wkładanie warzyw i owoców. Zbiornikna odpadki posiada pojemność aż 4 L dzięki czemu, nie ma konieczności ciągłego opróżniania. Regulowana prędkość od 5-70 obrotów na minutę. Elementy posiadające kontakt z żywnością wykonane ze stali nierdzewnej.

Very high capacity, up to 60 l / h. The large inlet opening of 79 mm allows for easy insertion of vegetables and fruit. The waste container has a capacity of up to 4 L, so there is no need to empty it constantly. Adjustable speed: 5-70 rpm. Components that come into contact with food are made of stainless steel.

MIXER-SHAKER

Idealny do koktajli, koktajli mlecznych, mrożonego cappuccino.

Perfect for cocktails, milkshakes, frozen cappuccinos.



Mikser-Shaker
Mixer-Shaker

Nr kat.	l cm	h cm	w cm	cap ml	W	kg	PLN	EUR
T-S54AN	18,6	53	18,2	675	120	6	2 578,35	-

Bardzo cichy silnik z bezstopniową regulacją prędkości od 8000 do 16000 obr./min. W zestawie dwa kubki do mieszania (tworzywo sztuczne/stal nierdzewna) o pojemności 675 ml. Trzy narzędzia: • Uniwersalna nasadka do wszystkich napojów • Specjalna nasadka do napojów kremowych • bardzo długa nasadka do kawy mrożonej.

Very quiet motor with stepless speed control from 8,000 to 16,000 rpm. Comes with two mixing cups (plastic / stainless steel) with a capacity of 675 ml. Three tools: • Universal attachment for all drinks • Special attachment for creamy drinks • Extra long attachment for iced coffee.





Wyciskarka do cytrusów Santos Citrus juicer Santos

Nr kat.	l cm	h cm	w cm	W	obr./m	kg	PLN	EUR
T-38G	30	35	22	130	1500	5	2 270,93	-

Obudowa emaliowana • Dwa demontowalne stożki dostosowane do wyciskania cytryn, pomarańczy i grejpfrutów • Oddzielna przykrywka na lejek • Demontowalna tacka ociekowa • Możliwość mycia w zmywarce lub gorącej wodzie wszystkich części demontowanych • Intuicyjna i prosta obsługa urządzenia

Enamelled casing • Two removable cones adapted for extrusion lemons, oranges and grapefruits • Separate lid on the funnel • Removable drip tray • The ability to wash in a dishwasher or hot water all dismantled parts • Intuitive and simple device operation



Wyciskarka do cytrusów Santos Citrus juicer Santos

Nr kat.	l cm	h cm	w cm	W	obr./m	kg	PLN	EUR
T-52G	20,5	49	30,5	230	1500	10	3 157,53	-

Obudowa aluminiowa, lakierowana • Lejek i filtr wykonane ze stali nierdzewnej • Trzy demontowalne rożki dostosowane do wyciskania limonek, cytryn, pomarańczy i grejpfrutów • Możliwość mycia w zmywarce lub gorącej wodzie wszystkich części demontowanych • Wyjątkowo cicha praca silnika

Aluminum housing, painted • Funnel and filter made of stainless steel • Three removable cones suitable for squeezing limes, lemons, oranges and grapefruit • The ability to wash all the parts in the dishwasher or hot water is dismantlable • Extremely silent engine operation



Sokowirówka Santos Juicer Santos

Nr kat.	l cm	h cm	w cm	W	obr./m	kg	PLN	EUR
T-50C	26	45	47	600	3600	16	8 270,89	-

Obudowa emaliowana • Przeznaczona głównie do obróbki owoców i warzyw miękkich • Tarcza ścierająca ze stali nierdzewnej o średnicy 165 mm • W standardzie kosz wirówkowy ze stali nierdzewnej; średnica oczek 0,5 mm • W standardzie pojemnik do gromadzenia miąższu • Lejek o wysokości 200 mm oraz kosz wirówkowy wykonane ze stali nierdzewnej • Średnica otworu podawczego (79,5 mm) umożliwia wprowadzenie dużych kawałków owoców i warzyw • Wszystkie części demontowane można myć w zmywarce lub gorącej wodzie • Średnia wydajność ekstrakcji: 70% (7kg soku z 10 kg owoców) • Wyjątkowo cicha praca silnika

Enamel casing • Designed mainly for processing soft fruits and vegetables • Stainless steel grinding wheel, diameter 165 mm • Standard centrifugal basket made of stainless steel; mesh diameter 0.5 mm • Standard container for collecting the pulp • Funnel with a height of 200 mm and a basket with a centrifuged made of stainless steel • The diameter of the delivery hole (79.5 mm) allows introducing large pieces of fruit and vegetables • All parts dismantled can be washed in a dishwasher or hot water • Average extraction efficiency: 70% (7kg of juice with 10 kg of fruit) • Extremely silent engine operation



Wyciskarka do cytrusów Dynajuicer Citrus juicer Dynajuicer

Nr kat.	Ø cm	l cm	W	obr./m	kg	PLN	EUR
DY-PA001	22,7	32	200	1500	6,3	1 320,66	-

Cichy i trwały silnik • Wykonany z tworzywa bezpiecznego w kontakcie z żywnością • Bardzo łatwe i szybkie czyszczenie

Quiet and durable engine • Made of a safe material in contact with food • Very easy and quick cleaning



Kruszarka do lodu WESSAMAT Ice crusher Wessamat

Nr kat.	l cm	h cm	w cm	W	kg	PLN	EUR
T-W103	33	32	18	150	10	4 299,00	-

Pojemnik z tworzywa • Pojemność: 1 kg lodu • Przystosowane do pracy ciągłej • Wydajność: 3 kg lodu na minutę • Nie używać do głęboko mrożonego lodu • Kompaktowy rozmiar • Urządzenie łatwe w użyciu

Plastic container • Capacity: 1 kg of ice • Adapted for continuous operation • Efficiency: 3 kg of ice per minute • Not suitable for deeply frozen ice • Compact size



Kruszarka do lodu WESSAMAT Ice crusher Wessamat

Nr kat.	l cm	h cm	w cm	W	kg	PLN	EUR
T-W105	37	51	31	150	25	7 299,00	-

Pojemnik z tworzywa • Pojemność: 5 kg lodu • Przystosowane do pracy ciągłej • Ogromna wydajność - kruszy 5 kg lodu na minutę • Nie używać do głęboko mrożonego lodu

Plastic container • Capacity: 5 kg of ice • Adapted for continuous operation • Great performance - crushes 5 kg of ice per minute • Not suitable for deeply frozen ice

KUP ON-LINE





100%Chef



N

Aromatyzator Aladin 007 Flavour; Al.
Professional Flavouring Smoker Super-Aladin; Al.

Nr kat.	col	PLN	EUR
C1-1092	złoty	1 384,60	-

Zestaw zawiera: aromatyzator, 100 ml roztworu spożywczego do tworzenia bąbelków, 4 beznikotynowe smaki parowe, 2 akumulatory 9 V, kabel do ładowania

Set includes: Aromatizer, 100 ml bubbling solution, 4 nicotine-free flavored steam cartridges, 2 9 V batteries, charging cable



100%Chef



Aromatyzator Aladin 007; Al
Professional Flavouring Smoker Aladin 007; Al.

Nr kat.	PLN	EUR
C1-1009	1 200,69	-

Służy do aromatyzowania koktajli • Zapasowe sitka

It is used for flavoring cocktails. • Spare sieves



BarEq

Atomizer; szkło
Atomizer; glass

Nr kat.	cap ml	PLN	EUR
T-TBA005	100	101,66	-

Lejek w zestawie

Funnel included



BAR

N

Atomizer; szkło
Atomizer; glass

Nr kat.	cap ml	PLN	EUR
BPR-00-100	100	64,58	-



BAR

N

Zestaw do aromatyzowania
Flavor kit

Nr kat.	PLN	EUR
BPR-SM-01	381,25	-

Zawiera: drewniany aromatyzator • szczotkę do czyszczenia • palnik • 4 rodzaje wiórów wędzarniczych (jabłko, wiśnia, dąb, biały orzech)

Includes: wooden flavorizer • cleaning brush • burner • 4 types of smoke chips (apple, cherry, oak, white walnut)



BarEq

Atomizer; stal
Atomizer; steel

Nr kat.	cap ml	PLN	EUR
T-TBA006	250	227,24	-

Lejek w zestawie

Funnel included



100%Chef

Trociny wędzarnicze; drewno z beczek
po Jack Daniels
Chips; Jack Daniel's barrel

Nr kat.	kg	PLN	EUR
C1-1028	0,85	151,02	-



100%Chef

Trociny wędzarnicze; drewno oliwne
Smoking chips; olive tree

Nr kat.	g	PLN	EUR
C1-10052	80	34,01	-



100%Chef

Trociny wędzarnicze; migdałowiec
Smoking chips; almond tree

Nr kat.	g	PLN	EUR
C1-10054	80	34,01	-



100%Chef

Trociny wędzarnicze; drewno z beczek
po Jack Daniels
Scobs; Jack Daniel's barrel

Nr kat.	g	PLN	EUR
C1-10-0042	80	36,21	-



100%Chef

Trociny wędzarnicze; buk
Scobs; beech

Nr kat.	g	PLN	EUR
C1-1004	80	26,43	-



100%Chef

Trociny wędzarnicze; dąb
Scobs; oak

Nr kat.	g	PLN	EUR
C1-1027	80	29,03	-





BAR
PROFESSIONAL

Zestaw barmański; 18/10
Bartender set; 18/10

Nr kat.	l cm	h cm	w cm	col	PLN	EUR
BPR-101	46	11	36	stalowy	520,89	-
BPR-102	46	11	36	miedziany	642,01	-
BPR-103	46	11	36	złoty	717,01	-



BAR
PROFESSIONAL

Zestaw barmański; 18/10, PVD
Bartender set; 18/10, PVD

Nr kat.	l cm	h cm	w cm	col	PLN	EUR
BPR-104	46	11	36	czarny	928,63	-



BAR
PROFESSIONAL

Torba barmańska; płótno, skóra
Bartender roll; canvas, leather

Nr kat.	PLN	EUR
BPR-BTRLL01	274,17	-



Torba nie zawiera wyposażenia | *The bag doesn't include accessories*



BAR
PROFESSIONAL

Shaker paryski; 18/10, PVD
Paris shaker; 18/10, PVD

Nr kat.	cap l	PLN	EUR
● BPR-02G	0,65	197,89	-
● BPR-03M	0,65	161,12	-
● BPR-03S	0,65	136,90	-



BarEq

Shaker francuski; 18/10
French shaker; 18/10

Nr kat.	cap l	PLN	EUR
T-CT05	0,5	46,19	-
T-CT07	0,7	49,52	-

Składa się z trzech części
Set of three parts

KUP ON-LINE





Shaker japoński; szkło
Japanese shaker; glass

Nr kat.	Ø cm	h cm	cap l	PLN	EUR
BPR-003	10	21	0,8	62,61	-



Shaker bostoński TIN TIN; 18/10
Boston shaker Tin Tin; 18/10

Nr kat.	cap l	PLN	EUR
BPR-800	0,8	64,22	-

Obciążone dno

Weighted bottom



Shaker bostoński Premium; 18/10, PVD
Boston shaker Premium; 18/10, PVD

Nr kat.	PLN	EUR
● BPR-02B	201,50	-
● BPR-02M	193,82	-
● BPR-02S	153,05	-
● BPR-800G	214,04	-

Obciążone dno
Weighted bottom



Shaker bostoński ze szklanką; 18/10, winyl, szkło
Boston shaker with glass; 18/10, vinyl, glass

Nr kat.	PLN	EUR
● BPR-800BL	84,84	-
● BPR-800IN	64,22	-

Obciążone dno, powłoka silikonowa
Weighted bottom, silicone coating



Shaker bostoński TIN TIN; 18/10
Boston shaker Tin Tin; 18/10

Nr kat.	cap l	PLN	EUR
BPR-05C	0,53	29,07	-
BPR-08C	0,82	32,36	-

Obciążone dno
Weighted bottom



BarEq

Shaker bostoński; 18/10, lakierowany
Boston shaker; 18/10, lacquered

Nr kat.	cap l	PLN	EUR
● T-TB02V	0,8	30,51	-
● T-TB04F	0,8	53,10	-

Małowany proszkowo
Powder coated



OPIS

Szklanka do shakera; szkło
Mixing glass; glass

Nr kat.	cap ml	PLN	EUR
ON-1639HT-1 (LB-1639HT-1)	473	23,28	-



ODS



ZWIESEL
GLAS

Classic Surfing

Szklanica Carats
Mixing glass; glass

Nr kat.	Ø cm	h cm	cap ml	kosz	op.	PLN	EUR
ON-2711VJR75-6 (LB-926781-6)	10,5	15	750	165534	6	67,03	-

Szklanica barmańska
Mixing glass; glass

Nr kat.		Ø cm	h cm	cap ml	kosz	op.	PLN	EUR
SH-8860-05-1	Classic	9,6	15	500	165534	1	179,55	-
SH-8860M-05-1	Surfing	9,6	15	500	165534	1	179,55	-



BAR
PROFESSIONAL



BarEq



Szklanica barmańska; szkło
Mixing glass; glass

Nr kat.	Ø cm	h cm	cap l	PLN	EUR
BPR-019	9,5	13,5	0,55	100,99	-

Szklanica barmańska; szkło
Mixing glass; glass

Nr kat.	Ø cm	h cm	cap l	PLN	EUR
TF-0301	11,5	19	1	54,69	-

Łyżka barmańska; 18/10, PVD
Bartending spoon; 18/10, PVD

Nr kat.	l cm	PLN	EUR
BPR-30B	30	68,69	-



KUP ON-LINE



Łyżka barmańska; 18/10, PVD
Bartending spoon; 18/10, PVD

Nr kat.	l cm	PLN	EUR
BPR-030G	30	80,75	-



Łyżka barmańska; 18/10, PVD
Bartending spoon; 18/10, PVD

Nr kat.	l cm	PLN	EUR
● BPR-30M	30	49,69	-
● BPR-30S	30	35,15	-



Łyżka barmańska; 18/10, PVD
Bartending spoon; 18/10, PVD

Nr kat.	l cm	PLN	EUR
● BPR-40M	40	54,53	-
● BPR-40S	40	35,62	-



BAR
PROFESSIONAL

Łyżka barmańska; 18/10, PVD
Bartending spoon; 18/10, PVD

Nr kat.	l cm	col	PLN	EUR
BPR-50G	50	miedziany	64,22	-
BPR-50S	50	stalowy	48,07	-

BAR
PROFESSIONAL

Łyżka barmańska; 18/10
Bartending spoon; 18/10

Nr kat.	l cm	PLN	EUR
BPR-033S	33,5	42,47	-

BarEq
Łyżka barmańska; 18/10
Bartending spoon; 18/10

Nr kat.	l cm	PLN	EUR
T-1530-305	30,5	8,76	-

BAR
PROFESSIONAL

Łyżka barmańska; 18/10
Bartending spoon; 18/10

Nr kat.	l cm	PLN	EUR
BPR-030S	30,5	42,47	-

BarEq
Łyżka barmańska z rurką; 18/10
Spoon with straw; 18/10

Nr kat.	l cm	PLN	EUR
T-265-195	19	12,59	-

BAR
PROFESSIONAL

Julep; 18/10, PVD
Julep; 18/10, PVD

Nr kat.	PLN	EUR
● BPR-06B	86,07	-
● BPR-1001-002G	83,71	-
● BPR-1001-002M	80,37	-
● BPR-1001-002S	55,88	-

BAR
PROFESSIONAL

Sito barmańskie; 18/10
Bar strainer; 18/10

Nr kat.	PLN	EUR
● BPR-07B	93,77	-
● BPR-07G	102,98	-
● BPR-07M	104,82	-
● BPR-007S	80,93	-

BarEq
Sito barmańskie; 18/10
Bar strainer; 18/10

Nr kat.	l cm	PLN	EUR
T-1510-2	14	14,70	-

BarEq
Sito barmańskie; 18/10
Bar strainer; 18/10

Nr kat.	l cm	PLN	EUR
T-TB6K	19	37,27	-

 Gęsta sprężyna
Tight spring

BarEq
Sito barmańskie; 18/10
Bar strainer; 18/10

Nr kat.	l cm	PLN	EUR
T-TB6H	20	40,64	-



BarEq



BarEq



eternum



Sito; stal
Strainer; steel

Sitko - bardzo gęste; 18/10
Fine strainer; 18/10

Sito barmańskie, stożkowe; 18/10
Bar strainer, conical; 18/10

Łyżka do absyntu; 18/10
Absynth spoon; 18/10

Nr kat.	Ø cm	l cm	PLN	EUR	Nr kat.	Ø cm	l cm	PLN	EUR
BPR-007C	7	23	40,22	-	ƒ-1210	7	21	20,10	-

Nr kat.	Ø cm	PLN	EUR
T-TBB006A	8,5	17,00	-

Nr kat.	l mm	w mm	PLN	EUR
E-771-1	167	34	27,94	-



BarEq



Miarka barmańska; 18/10
Measure; 18/10

Miarka japońska; 18/10
Japanese Measure; 18/10

Miarka japońska; 18/10,PVD
Japanese Measure; 18/10, PVD

Nr kat.	cap ml	PLN	EUR
T-2090-024	20-40	13,20	-
T-2090-025	25-50	13,46	-
T-2090-030	30-50	14,08	-

Nr kat.	cap ml	PLN	EUR
BPR-2550	25-50	62,61	-
BPR-CJC2040	20-40	38,42	-

Nr kat.	cap ml	PLN	EUR
● BPR-2550G	25-50	101,84	-
● BPR-2550M	25-50	81,77	-



Miarka japońska; 18/10,PVD
Japanese Measure; 18/10, PVD

Miarka Mr Slim; 18/10
Measure Mr Slim; 18/10

Nr kat.	col	PLN	EUR
BPR-3045B	czarny	84,46	-

Nr kat.	cap ml	PLN	EUR
BPR-2550S	25-50	80,37	-



KUP ON-LINE



BarEq



Miarka; 18/10
Measure; 18/10

Nr kat.	cap ml	PLN	EUR
T-549-010	100	14,16	-
T-549-025	250	22,04	-

Podziałka wewnątrz
Measure inside

BarEq



Miarka; 18/10
Measure; 18/10

Nr kat.	g	PLN	EUR
T-3038	7	23,92	-

TOMGAST



Zestaw miarek; 18/10
Measuring cups; 18/10

Nr kat.	PLN	EUR
T-80037	33,10	-

BarEq



Łyżeczki miarki; 18/10
Measure spoons; 18/10

Nr kat.	PLN	EUR
T-1001-3	30,75	-

BarEq



Wyciskacz do cytrusów; tworzywo
Lemon squeezer; plastic

Nr kat.	PLN	EUR
T-TB18B	53,10	-

BarEq



Wyciskacz do cytrusów; tworzywo
Lemon squeezer; plastic

Nr kat.	PLN	EUR
T-TB18Y	53,10	-

BarEq



Wyciskacz do cytrusów; 18/10
Lemon squeezer; 18/10

Nr kat.	Ø cm	PLN	EUR
T-12002	12,5	49,52	-

BarEq



Wyciskacz do plasterów cytryny; 18/10
Lemon squeezer; 18/10

Nr kat.	w cm	PLN	EUR
T-11006	7	5,80	-





Wyciskacz do cytrusów; Al
Lemon squeezer; Al.

Nr kat.	PLN	EUR
BPR-11006	80,37	-

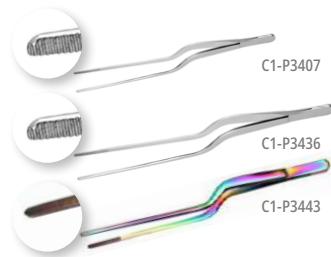

100%Chef

Pinceta; 18/10
Tweezers; 18/10

Nr kat.	l cm	PLN	EUR
C1-P3407	14	37,41	-
C1-P3436	20	43,19	-
C1-P3443	powł. tytanowa 20	79,10	-



BarEq

Muddler; ABS
Muddler; ABS

Nr kat.	l cm	PLN	EUR
T-VCP31	21	14,19	-
T-VCP33	24	24,11	-



BarEq

Muddler; ABS
Muddler; ABS

Nr kat.	l cm	PLN	EUR
T-VCP30	21	14,19	-
T-VCP32	24	24,11	-



BarEq

Muddler; drewno
Muddler; wood

Nr kat.	l cm	PLN	EUR
T-2020	22	14,96	-



Muddler; 18/10
Muddler; 18/10

Nr kat.	l cm	PLN	EUR
BPR-MUDR001	21	64,66	-



Muddler; ABS
Muddler; ABS

Nr kat.	l cm	PLN	EUR
BPR-MUDH001	22	27,84	-

KUP ON-LINE





BarEq

Muddler XL; PC
Muddler XL; PC

Nr kat.	l cm	w cm	PLN	EUR
T-TB02XLW	29,5	4	37,27	-



BarEq

Muddler; ABS
Muddler; ABS

Nr kat.	l cm	w cm	PLN	EUR
● T-TB02	21,5	3,5	17,00	-
● T-TB02F	21,5	3,5	22,59	-
● T-TB02GL	21,5	3,5	22,59	-



BarEq

Deska barmańska; PE
Cutting board; PE

Nr kat.	l cm	w cm	thk mm	PLN	EUR
T-30202	30	20	20	44,97	-
T-50302	50	30	20	121,13	-

Polietylen nietoksyczny • Odporna na temp. do 60°C • Antypoślizgowe gumowe stopki

Non-toxic polyethylene • Resistant up to 60°C • Anti-slip rubber feet



TOMGAST

Obieraczka do warzyw; stal węglowa, tworzywo
Peeler; carbon steel, plastic

Nr kat.	l cm	w cm	PLN	EUR
T-80022	12	5	21,97	-



TOMGAST

Obieraczka julienne; stal węglowa, tworzywo
Peeler julienne; carbon steel, plastic

Nr kat.	l cm	PLN	EUR
T-80020	17	19,53	-



TOMGAST

Obieraczka do warzyw; stal węglowa, tworzywo
Peeler; carbon steel, plastic

Nr kat.	PLN	EUR
T-80021	21,97	-





Zester; stal węglowa, tworzywo
Zester; carbon steel, plastic

Nr kat.	l cm	PLN	EUR
T-80007	15,5	24,87	-



Nóż dekoracyjny; stal nierdzewna, tworzywo
Decoration knife; SS, plastic

Nr kat.	l cm	PLN	EUR
T-80008	15,5	22,17	-



Wycinak do pomidorów; tworzywo, 18/10
Tomato shark; plastic, 18/10

Nr kat.	Ø mm	l cm	w cm	PLN	EUR
T-80016	22	15	6	24,87	-



Nóż do obierania grejpfruta; stal nierdzewna, tworzywo
Grapefruit peeler; SS, plastic

Nr kat.	l cm	PLN	EUR
T-80017	21	26,40	-



Nóż do cytrusów; stal nierdzewna, tworzywo
Citrus peeler; SS, plastic

Nr kat.	l cm	PLN	EUR
T-80019	17,5	22,17	-



Wydrążacz do jabłek; tworzywo, 18/10
Apple corer; plastic, 18/10

Nr kat.	l cm	PLN	EUR
T-80006	21,5	22,17	-

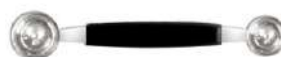

Nóż dekoracyjny, okrągły 22/25 mm; tworzywo, 18/10
Melon baller 22/25 mm; plastic, 18/10

Nr kat.	Ø mm	l cm	PLN	EUR
T-80005	22/25	16,3	30,09	-





Dyspenser barmański; PP
Bar dispenser; PP



Nr kat.	cap l	PLN	EUR
● BPR-BP8021G	2	48,83	-
● BPR-BP8021R	2	48,83	-
● BPR-BP8021Y	2	48,83	-
● BPR-BPMC100G	1	37,29	-
● BPR-BPMC100R	1	37,29	-
● BPR-BPMC100Y	1	37,29	-



Dyspenser do sosów z miarką, precyzyjny; PE
Sauce dispenser; PE

Nr kat.	Ø cm	h cm	cap l	PLN	EUR
T-195-194	5,1	7,9	0,05	26,78	-
T-195-195	6,1	13,4	0,25	32,64	-
T-195-196	7,8	16,2	0,5	40,13	-
T-195-197	9,7	22,3	1	54,34	-



BarEq

Butelka treningowa; tworzywo
Training bottle; plastic

Nr kat.	cap l	PLN	EUR
○ BPR-150-070	0,75	54,25	-
● BPR-150-172	0,75	79,80	-



Menzurka do ćwiczeń free pouringu; tworzywo
Free pouring trainer; plastic

Nr kat.	Ø cm	h cm	PLN	EUR
BPR-1001-003	10	18	67,45	-



T-61136

T-61134

Pojemnik na przyprawy; tworzywo
Spice dispenser; plastic

Nr kat.	l cm	h cm	w cm	cap ml	PLN	EUR
T-61136	50	9	16	450	111,91	-
T-61134	50	9	16	750	111,91	-



BarEq

Tace do dekoracji kieliszków; tworzywo
Decorating trays; plastic

Nr kat.	l cm	h cm	w cm	PLN	EUR
T-B012	37,5	9	14	52,73	-





BarEq

Pomocnik barmański; drewno
Bar Caddy; wood

Nr kat.	l cm	h cm	w cm	PLN	EUR
T-TBB001WD	25	10,5	25	50,88	-



Pomocnik barmański; tworzywo
Bar caddy; plastic

Nr kat.	l cm	h cm	w cm	col	PLN	EUR
BPR-04	24	10,5	15	inox	75,07	-

Tworzywo w kolorze stali chromowanej
Material in chrome-plated steel



BarEq

Pomocnik barmański; tworzywo
Bar caddy; plastic

Nr kat.	l cm	h cm	w cm	PLN	EUR
● T-132-11	15	10,5	24	42,18	-
○ T-TB01W	25	10,5	25	41,81	-



Bar Caddy; drewno orzechowe
Bar caddy; nut

Nr kat.	l cm	h cm	w cm	PLN	EUR
BPR-06	26	11	15,5	177,27	-

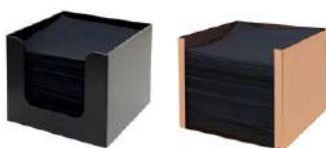

Pojemnik na serwetki; tworzywo
Napkin holder; plastic

Nr kat.	l cm	h cm	w cm	PLN	EUR
● BPR-10C	13,8	10,2	13,8	38,53	-
● BPR-10M	13,8	10,2	13,8	127,32	-



Pomocnik barmański; tworzywo
Bar caddy; plastic

Nr kat.	l cm	h cm	w cm	PLN	EUR
BPR-03	24	10	15	40,00	-



Nalewak; naturalny korek, stal
Pourer; cork, steel

Nr kat.	PLN	EUR
BPR-006	17,16	-



Nalewak; stal
Pourer; steel

Nr kat.	PLN	EUR
BPR-10200	9,52	-



BarEq

Nalewak; stal
Pourer; steel

Nr kat.	PLN	EUR
T-TB01	8,15	-



Nalewak z regulacją przepływu; stal, PVD
Pourer, adjustment flow; steel, PVD

Nr kat.	PLN	EUR
BPR-SOL	20,00	-



Nalewak; stal, PVD
Pourer; steel, PVD

Nr kat.	PLN	EUR
BPR-SLSC	15,82	-



BarEq

Nalewak precyzyjny; stal
Precision pourer; steel

Nr kat.	PLN	EUR
T-31100	16,72	-

KUP ON-LINE





BarEq

Nalewak; tworzywo
Pourer; plastic

Nr kat.	PLN	EUR
T-TBP006MG	4,28	-



BarEq

Nalewak; tworzywo
Pourer; plastic

Nr kat.	PLN	EUR
T-TBP006MS	4,28	-



BarEq

Nalewak; tworzywo
Pourer; plastic

Nr kat.	PLN	EUR
T-TB05G	7,42	-



BarEq

Nalewak; tworzywo
Pourer; plastic

Nr kat.	PLN	EUR
T-TB05R	7,42	-



BarEq

Nalewak; tworzywo
Pourer; plastic

Nr kat.	PLN	EUR
T-TB05B	7,42	-



BarEq

Nalewak; tworzywo
Pourer; plastic

Nr kat.	PLN	EUR
T-TB05C	7,42	-



BarEq

Nalewak; tworzywo
Pourer; plastic

Nr kat.	PLN	EUR
T-TBP3MS	1,67	-



Nalewak; tworzywo
Pourer; plastic

Nr kat.	PLN	EUR
BPR-38000	3,56	-





Nalewak; tworzywo
Pourer; plastic

Nr kat.	PLN	EUR
BPR-38100	3,56	-



BarEq

Nalewak; tworzywo
Pourer; plastic

Nr kat.	PLN	EUR
T-38300	1,43	-



Nalewak; stal
Pourer; steel

Nr kat.	PLN	EUR
BPR-010	4,68	-

Średni przepływ
Medium flow



Nalewak; tworzywo
Pourer; plastic

Nr kat.	PLN	EUR
BPR-007	4,68	-

Szybki przepływ
Fast flow



BarEq

Nalewak, porcjomierz; tworzywo
Pourer, portion counting; plastic

Nr kat.	cap ml	PLN	EUR
T-98020	20	12,35	-
T-98040	40	12,35	-
T-98050	50	12,35	-



Dziurkacz do kapsli; tworzywo
Cap puncher; plastic

Nr kat.	PLN	EUR
BPR-018	80,37	-



Kapslnik; stal, tworzywo
Crimper for cups; steel, plastic

Nr kat.	PLN	EUR
C1-1074	96,60	-



C1-1073



C1-1075

100%Chef

Butelki; szkło
Bottles; glass

Nr kat.		Ø cm	h cm	cap ml	op.	PLN	EUR
C1-1073	butelki 200 ml	5	18	200	24	113,32	-
C1-1075	kapsle (złote); stal				100	36,91	-



Zatyczka uniwersalna; tworzywo
Universal plug; plastic

Nr kat.	PLN	EUR
BPR-012	8,42	-



Butelka do aromatyzowania; szkło
Dash bottle; glass

Nr kat.	cap ml	PLN	EUR
BPR-160-100	100	50,54	-



BarEq

Butelka; szkło
Bottle; glass

Nr kat.	h cm	cap ml	PLN	EUR
T-TB04M	13	250	15,78	-

KUP ON-LINE





Trybuszon Clavelin; stal, tworzywo
Corkscrew Clavelin; steel, plastic

Nr kat.	l cm	PLN	EUR
PG-200428	14	101,75	-



BarEq

Trybuszon; stal, tworzywo
Corkscrew; steel, plastic

Nr kat.	l cm	PLN	EUR
T-3720	12	16,63	-



BarEq

Otwieracz barmański; tworzywo, 18/10
Corkscrew; plastic, 18/10

Nr kat.	l cm	PLN	EUR
T-23001	12	15,11	-



BarEq

Otwieracz; 18/10, winyl
Bottle opener; 18/10, vinyl

Nr kat.	l cm	PLN	EUR
BPR-1001-001	18	8,41	-



Otwieracz do starych korków; stal
Old cork opener; steel

Nr kat.	l cm	col	PLN	EUR
PG-200251	15,7	czarny	101,75	-
PG-200367	15,7	bazaltowy	101,75	-

Pozwala otworzyć butelkę bez wiercenia korka • Idealne do starych win z korkami, które mają tendencję do kruszenia

Allows you to open the bottle without drilling the cork. • Ideal for old wines with corks that tend to crumble

Trybuszon, stal
Corkscrew; steel

Nr kat.	l cm	PLN	EUR
T-454-180	17,5	17,33	-

BarEq



BarEq

Otwieracz; stal nierdzewna
Bottle opener; SS

Nr kat.	l cm	PLN	EUR
T-3580	18	12,35	-

BarEq



Otwieracz; 18/0
Bottle opener; 18/10

Nr kat.	l cm	PLN	EUR
T-3510	10	5,70	-



Otwieracz; 18/10, winyl
Bottle opener; 18/10, vinyl

Nr kat.	l cm	PLN	EUR
BPR-OBSSM01	12	31,92	-



Klucz do wina; stal
Key for wine; steel

Nr kat.	PLN	EUR
PG-245078	195,14	-

Klucz pozwala postarzyć (utlenić) i ujawnić cechy wina • Działa skutecznie na wszystkie rodzaje wina: białe, musujące, czerwone i naturalnie słodkie • Z kluczem można wyregulować balans smaku wina do gustu lub dokładnie ocenić jak rozwinie się z czasem smak wina sezonowanego

The key allows you to set (oxidize) and reveal the characteristics of the wine • Works effectively on all types of wine: white, sparkling, red and naturally sweet • With the key you can adjust the taste balance of wine to your taste or accurately assess how the taste of seasoned wine will develop over time



Pompka do wina z zatyczkami do wina
Vacuum pump with wine plugs

Nr kat.		PLN	EUR
PG-210045	pompka próżniowa do wina + 2 korki do wina	81,41	-
PG-210052	pompka próżniowa do wina i szampana + 2 korki do wina i 1 do szampana	125,70	-
PG-210069	4 korki próżniowe do wina	47,89	-
PG-210076	korek próżniowy do szampana	47,89	-

Korek do szampana
Champagne plug

Nr kat.	Ø cm	w cm	PLN	EUR
T-350-058	3,5	5,5	14,89	-



BarEq



Kraszuarka; tworzywo
Spittoon; plastic

Nr kat.	Ø cm	h cm	PLN	EUR
BPR-P02	14	15,5	96,52	-



Kulki do czyszczenia dekantera; 18/10
Spheres for cleaning decanter; 18/10

Nr kat.	PLN	EUR
PG-230241	49,08	-

KUP ON-LINE



BAR
PROFESSIONAL

Regał na butelki do wina mały
Bottle rack

Nr kat.	dim cm	PLN	EUR
BPR-030	43 x 34 x 24	306,47	-

 pojemność: 16 sztuk
holds 16 bottles

BAR
PROFESSIONAL

Regał na butelki
Bottle rack

Nr kat.	dim cm	PLN	EUR
BPR-021	61,5 X 44 X 24	508,35	-

 pojemność: 30 sztuk
holds 30 bottles

BAR
PROFESSIONAL

Regał na butelki
Bottle rack

Nr kat.	dim cm	PLN	EUR
BPR-022	62 x 63 x 24	686,38	-

 pojemność: 42 sztuki
holds 42 bottles

KUP ON-LINE



eternum

Cooler; stal nierdzewna
Cooler; SS

Nr kat.	Ø cm	h cm	PLN	EUR
E-2908	21,5	21	439,99	-

 Nie zawiera podstawy
Cooler stand not included

BarEq

Podstawa do coolera; 18/10
Cooler stand; 18/10

Nr kat.	Ø cm	h cm	PLN	EUR
T-121P	20	59,5	227,12	-



eternum

Podstawa do coolera; 18/10
Cooler stand; 18/10

Nr kat.	h cm	PLN	EUR
E-2900	59,5	646,23	-

 Nie zawiera coolera
Cooler not included



BarEq

Cooler; 18/10
Cooler; 18/10

Nr kat.	Ø cm	h cm	cap l	PLN	EUR
T-101W	21,7	22	3,5	119,92	-



BarEq

Cooler; 18/10
Cooler; 18/10

Nr kat.	Ø cm	h cm	cap l	PLN	EUR
T-G02W	19	18,5	3,7	80,28	-



BarEq

Uchwyt do coolera; 18/10
Cooler holder; 18/10

Nr kat.	Ø cm	h cm	w cm	PLN	EUR
T-2902	18,4	17	50	71,25	-



BAR
PROFESSIONAL

Misa do szampana; 18/10, PVD
Champagne cooler; 18/10, PVD

Nr kat.	Ø cm	h cm	PLN	EUR
BPR-3523	34	22	282,25	-



BarEq

Misa do szampana; 18/10
Champagne cooler; 18/10

Nr kat.	Ø cm	h cm	cap l	PLN	EUR
T-2680	38	25	12	204,25	-



BAR
PROFESSIONAL

Misa do szampana; 18/10
Champagne cooler; 18/10

Nr kat.	Ø cm	h cm	PLN	EUR
TF-34	44	24	504,74	-

Izolowana, podwójne ścianki • Doskonale sprawdza się również na bufecie śniadaniowym, do podawania np. jogurtów
Insulated double walls • Suitable to cold buffet for serving yoghurt etc.



BAR
PROFESSIONAL

Misa do szampana
Champagne cooler

Nr kat.	Ø cm	h cm	col	PLN	EUR
BPR-3500-B	34	22	czarny	312,43	-

pojedyncza ścianka
Single walled

N



BAR
PROFESSIONAL

Misa do szampana
Champagne cooler

Nr kat.	Ø cm	h cm	col	PLN	EUR
BPR-3500-G	34	22	złoty	285,48	-

pojedyncza ścianka
Single walled

N



BAR
PROFESSIONAL

Cooler; stal nierdzewna
Cooler; stainless steel

Nr kat.	Ø cm	h cm	PLN	EUR
BPR-MA01	19	30	254,20	-

pojedyncza ścianka
Single walled

N

KUP ON-LINE





Cooler; stal nierdzewna
Cooler; stainless steel

Nr kat.	Ø cm	h cm	PLN	EUR
BPR-ER01	20	30	254,20	-

pojedyncza ścianka
Single walled



Cooler; stal ocynkowana
Cooler; galvanized steel

Nr kat.	l cm	h cm	w cm	PLN	EUR
BPR-TUB4937	49	22	37	281,15	-



Cooler; akryl
Cooler; acrylic

Nr kat.	l cm	h cm	w cm	PLN	EUR
BPR-N01	48	24	21	225,72	-
BPR-WLED	Taśma ledowa	39,5	—	5,5	322,62



Cooler; akryl
Cooler; acrylic

Nr kat.	Ø cm	h cm	PLN	EUR
BPR-2001-001	21	25	111,06	-



Cooler; PS
Cooler; PS

Nr kat.	Ø cm	h cm	PLN	EUR
BPR-2001-005	20	28	48,58	-



Cooler; akryl
Cooler; acrylic

Nr kat.	Ø cm	h cm	PLN	EUR
BPR-20012	34	27	258,02	-





BarEq



BarEq

Cooler; 18/10, PVD
Cooler; 18/10, PVDCooler; 18/10
Cooler; 18/10Cooler; PVC
Cooler; PVC

Nr kat.	Ø cm	h cm	PLN	EUR
BPR-WKCP	12	20	153,05	-

Nr kat.	Ø cm	h cm	PLN	EUR
T-36030	12	20	67,55	-

Nr kat.	h cm	PLN	EUR
FF-902	28/37	31,83	-

Izolowany, podwójne ścianki • Maks. śr. butelki: 9 cm
Insulated double walls • Max dim. of bottles: 9 cmIzolowany, podwójne ścianki • Maks. śr. butelki: 9 cm
Insulated double walls • Max dim. of bottles: 9 cm

BarEq

Szczypce do lodu ; stal
Ice tongs; steelSzczypce; 18/10
Tongs; 18/10Szczypce; 18/10
Tongs; 18/10Szczypce; 18/10
Tongs; 18/10

Nr kat.	l cm	PLN	EUR
BPR-ISCC001	18	24,39	-

Nr kat.	l cm	PLN	EUR
BPR-ISCC01	18	18,24	-

Nr kat.	l cm	PLN	EUR
T-6460	16	28,74	-

Nr kat.	l cm	PLN	EUR
AB-905	20	17,19	-



BarEq



BarEq



BarEq

Szczypce; 18/10
Tongs; 18/10Szczypce; 18/10
Tongs; 18/10Szczypce; 18/10
Tongs; 18/10

Nr kat.	l cm	PLN	EUR
T-1106AP	18	7,98	-

Nr kat.	l cm	PLN	EUR
T-1550-135	13,5	8,76	-

Nr kat.	l cm	PLN	EUR
T-1550-145	14,5	9,51	-



BarEq

Łopatką do lodu; PC
Ice scoop; PCSzufelka perforowana; 18/10
Perforated scoop; 18/10Pojemnik na lód; tworzywo
Ice container; plasticPojemnik na lód; tworzywo
Ice container; plastic

Nr kat.	l cm	PLN	EUR
T-TB014	26,5	22,26	-

Nr kat.	Ø cm	l cm	PLN	EUR
BPR-1002	5,5	19	40,00	-
T-1038-2	4,5	19	68,59	-

Nr kat.	cap l	PLN	EUR
BPR-0010	8	209,57	-

Nr kat.	cap l	PLN	EUR
BPR-0400	4	88,45	-

KUP ON-LINE





Pojemnik na lód; 18/10, tworzywo
Ice container; 18/10, plastic

Nr kat.	Ø cm	h cm	cap l	PLN	EUR
AB-520	15	17	1	214,37	-



Wiaderko na lód; 18/10
Ice bucket; 18/10

Nr kat.	Ø cm	h cm	cap l	PLN	EUR
T-10119	12,5	11,8	1	62,99	-

BarEq



BarEq

Pojemnik na lód; 18/10, tworzywo
Ice container; 18/10, plastic

Nr kat.	Ø cm	h cm	cap l	PLN	EUR
T-1001-014	15	20,5	2	60,76	-

BAR
PROFESSIONAL

Forma do lodu; silikon
Ice mold; silicone

Nr kat.	PLN	EUR
BPR-Y040 4x4x4 cm 6 szt.	50,54	-

BAR
PROFESSIONAL

Forma do lodu; silikon
Ice mold; silicone

Nr kat.	PLN	EUR
BPR-Y030 3x3x3 cm 15 szt.	50,54	-

BAR
PROFESSIONAL

Forma do lodu; silikon
Ice mold; silicone

Nr kat.	PLN	EUR
BPR-064 śr. 6 cm 4 szt.	60,49	-



BarEq

Forma do lodu; PP
Ice mold; PP

Nr kat.	l cm	h cm	w cm	PLN	EUR
TF-1290 śr. 6 cm 3 szt.	23,5	6,5	8,5	54,63	-

BAR
PROFESSIONAL

Forma do lodu; silikon
Ice mold; silicone

Nr kat.	PLN	EUR
BPR-045 śr. 5 cm 8 szt.	110,85	-

BAR
PROFESSIONAL

Forma do lodu; Al
Ice mold; Al

Nr kat.	Ø cm	h cm	PLN	EUR
BPR-M01	12,5	16	2 414,43	-





BarEq

Dłuto do lodu; stal, drewno
Ice pick; steel, wood

Nr kat.	l cm	w cm	PLN	EUR
T-2105	23,5	6,3	27,08	-



Młotek do lodu; drewno
Ice hammer; wood

Nr kat.	l cm	w cm	PLN	EUR
BPR-H01	25	11	161,12	-



Worek do lodu; płótno
Ice bag; cloth

Nr kat.	l cm	w cm	PLN	EUR
BPR-B01	34,5	21,5	80,37	-



BarEq

Schody podświetlane LED; tworzywo
Stairs, LED illuminated; plastic

Nr kat.	l cm	h cm	w cm	PLN	EUR
T-LD02	100	44	44	2 222,72	-

16 kolorów do wyboru • Sterowanie pilotem
16 colors to choose from • Remote control



BarEq

Opaska barmańska; stal
Armband; steel

Nr kat.	col	PLN	EUR
T-TBA001	czarny	75,69	-



Fartuch sommelierski Malte
Sommelier apron Malte

Nr kat.	l cm	w cm	col	PLN	EUR
U-MA-B	110	95	czarny	241,40	-

Polibawełna 245 g / m² • Regulowany pas • 1 kieszeń na piersi i 1 dolna kieszeń

Polycotton 245 g / m² • Adjustable waistband • 1 chest pocket and 1 bottom pocket

KUP ON-LINE





BarEq

Wieszak na kieliszki; mosiądz
Glass hanger; brass

Nr kat.	l cm	w cm	PLN	EUR
BPR-3014	30,8	11	37,38	-
BPR-4011	40	11	41,42	-



Wieszak na kieliszki; 18/10
Glass hanger; 18/10

Nr kat.	l cm	PLN	EUR
T-164-02	40	11,98	-
T-164-3	60	14,94	-



BarEq

Minutnik; tworzywo
Timer; plastic

Nr kat.	PLN	EUR
T-JF16	28,50	-

Funkcja minutnika i stopera • Magnes z tyłu
Timer and stopwatch function • Magnet at the back



BarEq

Szpikulec na bony; stal
Bills pin; steel

Nr kat.	Ø cm	h cm	PLN	EUR
T-1055	8	15,5	8,55	-

BarEq



Podkładka; drewno
Pad; wood

Nr kat.	l cm	h cm	w cm	PLN	EUR
T-TBD003	12	0,8	8	14,84	-



Podkładka; tworzywo
Pad; plastic

Nr kat.	l cm	w cm	PLN	EUR
T-TBD004	10	10	9,08	-

BarEq



Mata barowa; tworzywo
Bartending mat; plastic

Nr kat.	l cm	w cm	col	PLN	EUR
BPR-700-061	500	61	●	188,86	-
BPR-800-061	500	61	○	188,86	-



BarEq

Mata barmańska; tworzywo
Bartending mat; plastic

Nr kat.	l cm	w cm	PLN	EUR
● T-TB08	70	10	45,18	-
● T-TB08W	70	10	45,18	-



Mata barmańska; kauczuk
Bartending mat; caoutchouc

Nr kat.	l cm	w cm	PLN	EUR
BPR-BMC1530	30	15	50,54	-



BarEq

Mata barmańska; kauczuk
Bartending mat; caoutchouc

Nr kat.	l cm	h cm	w cm	PLN	EUR
T-BMQ	45	1	31	57,30	-





BarEq

Ociekacz; tworzywo
Drip; plastic

Nr kat.	l cm	w cm	PLN	EUR
T-TB10BLK	33	33	23,20	-



BarEq

Taca okrągła; włókno szklane, guma
Tray round; polyglass, rubber

Nr kat.	Ø cm	h cm	PLN	EUR
BQ-35522	35,5	2,2	32,30	-
BQ-40522	40,5	2,2	43,70	-



BarEq

Taca prostokątna; włókno szklane, guma
Tray rectangular; polyglass, rubber

Nr kat.	l cm	h cm	w cm	PLN	EUR
BQ-45352	45,7	2,2	35,6	45,60	-



CAMBRO

Taca Camtread; poliglass, guma, Al
Waiters tray; polyglass, rubber, Al.

Nr kat.	l cm	w cm	PLN	EUR
CM-1418CT138	46	36	75,43	-

Odporna na temp. - 10°C do 100°C. Gumowana łącznie z brzegami.
Odporna na intensywne użytkowanie.

Temp resistant -10 to 100 C. Rubberized with rims. Heavy duty.



CAMBRO

Taca owalna Camtread; poliglass, guma, Al
Waiters tray; polyglass, rubber, Al.

Nr kat.	l cm	w cm	PLN	EUR
● CM-2700CT110	68,5	56	150,48	-
● CM-2700CT138	68,5	56	150,48	-

Odporna na temp. - 10°C do 100°C. Gumowana łącznie z brzegami.
Odporna na intensywne użytkowanie.

Temp resistant -10 to 100 C. Rubberized with rims. Heavy duty.



CAMBRO

Taca Camtread; poliglass, guma, Al
Waiters tray; polyglass, rubber, Al.

Nr kat.	Ø cm	PLN	EUR
● CM-1400CT110	35,5	48,84	-
● CM-1400CT138	35,5	48,84	-
● CM-1600CT110	40,5	65,56	-
● CM-1600CT138	40,5	65,56	-
● CM-1800CT110	45	81,67	-

Odporna na temp. - 10°C do 100°C. Gumowana łącznie z brzegami. Odporna na intensywne użytkowanie.

Temp resistant -10 to 100 C. Rubberized with rims. Heavy duty.



CAMBRO

Taca Treadlite; poliglass, guma
Waiters tray; polyglass, rubber

Nr kat.	l cm	w cm	PLN	EUR
● CM-1418TL110	46	36	86,07	-
● CM-1418TL138	46	36	86,07	-

Odporna na temp. - 10°C do 80°C. Odporna na umiarkowane użytkowanie.

Temp resistant -10 to 80 C. Medium intensity of use.



CAMBRO

Taca Treadlite; poliglass, guma
Waiters tray; polyglass, rubber

Nr kat.	Ø cm	PLN	EUR
● CM-1400TL110	35,5	56,86	-
● CM-1400TL138	35,5	56,86	-
● CM-1600TL110	40,5	76,81	-
● CM-1600TL138	40,5	76,81	-

Odporna na temp. - 10°C do 80°C. Odporna na umiarkowane użytkowanie.

Temp resistant -10 to 80 C. Medium intensity of use.



KUP ON-LINE



Rurki zielone; papier
Green straw; paper

Nr kat.	Ø cm	l cm	op.	PLN	EUR
FF-2508PG	0,8	25	100	13,97	-

Powyższa cena jest ceną za opakowanie. Ilość szt. w opakowaniu: 100.

Price per pack. Quantity in package: 100.



Rurki czerwone; papier
Red straw; paper

Nr kat.	Ø cm	l cm	op.	PLN	EUR
FF-2108PR	0,8	21	100	11,69	-
FF-2508PR	0,8	25	100	13,97	-

Powyższa cena jest ceną za opakowanie. Ilość szt. w opakowaniu: 100.

Price per pack. Quantity in package: 100.



Rurki natural; papier
Natural straw; paper

Nr kat.	Ø cm	l cm	op.	PLN	EUR
FF-2108P	0,8	21	100	11,69	-

Powyższa cena jest ceną za opakowanie. Ilość szt. w opakowaniu: 100.

Price per pack. Quantity in package: 100.



Rurki czarne; papier
Black straw; paper

Nr kat.	Ø cm	l cm	op.	PLN	EUR
FF-1408K	0,8	14	100	8,12	-
FF-2108K	0,8	21	100	11,69	-
FF-2508K	0,8	25	100	13,97	-

Powyższa cena jest ceną za opakowanie. Ilość szt. w opakowaniu: 100.

Price per pack. Quantity in package: 100.



Rurki florystyczne błękitne; papier
Floristic straw; paper

Nr kat.	Ø cm	l cm	op.	PLN	EUR
FF-2108FB	0,8	21	100	11,69	-

Powyższa cena jest ceną za opakowanie. Ilość szt. w opakowaniu: 100.

Price per pack. Quantity in package: 100.



Rurki florystyczne białe; papier
Floristic straw; paper

Nr kat.	Ø cm	l cm	op.	PLN	EUR
FF-2108FW	0,8	21	100	11,69	-

Powyższa cena jest ceną za opakowanie. Ilość szt. w opakowaniu: 100.

Price per pack. Quantity in package: 100.



Rurki z czyścikiem; 18/10
Straw with cleaner; 18/10

Nr kat.	op.	PLN	EUR
BPR-S04	4	38,38	-

Długość słomki: 26,5 cm

Straw's length: 26,5 cm



Patyczki bambusowe
Bamboo sticks

Nr kat.	l cm	op.	PLN	EUR
V-30000	7	100	7,30	-
V-30001	10,5	100	9,83	-
V-30002	15	100	6,10	-



Patyczki bambusowe
Bamboo sticks

Nr kat.	l cm	op.	PLN	EUR
V-30003	12	100	8,27	-



Patyczki Bucke
Buckle sticks

Nr kat.	l cm	op.	PLN	EUR
V-30004	15	100	16,25	-



Patyczki bambusowe
Bamboo sticks

Nr kat.	l cm	op.	PLN	EUR
V-30019	12	50	6,70	-



Patyczki bambusowe
Bamboo sticks

Nr kat.	l cm	op.	PLN	EUR
V-30017	12	100	8,84	-



Patyczki bambusowe
Bamboo sticks

Nr kat.	l cm	op.	PLN	EUR
V-30018	12	100	7,64	-



Patyczki Golf
Golf sticks

Nr kat.	l cm	op.	PLN	EUR
V-30005	12	100	4,20	-
V-30006	18	100	4,56	-



Patyczki bambusowe
Bamboo sticks

Nr kat.	l cm	op.	PLN	EUR
V-30025	12	100	15,96	-



Patyczki bambusowe
Bamboo sticks

Nr kat.	l cm	op.	PLN	EUR
V-30026	12	100	14,39	-



Patyczki bambusowe
Bamboo sticks

Nr kat.	l cm	op.	PLN	EUR
V-30016	12	100	8,66	-



Patyczki bambusowe
Bamboo sticks

Nr kat.	l cm	op.	PLN	EUR
V-30015	12	100	8,12	-



Patyczki bambusowe
Bamboo sticks

Nr kat.	l cm	op.	PLN	EUR
V-30014	7,2	100	6,74	-



Patyczki bambusowe
Bamboo sticks

Nr kat.	l cm	op.	PLN	EUR
V-30024	15	100	4,77	-



Patyczki bambusowe
Bamboo sticks

Nr kat.	l cm	op.	PLN	EUR
V-30009	25	100	2,39	-



Patyczki bambusowe
Bamboo sticks

Nr kat.	l cm	op.	PLN	EUR
V-30007	8,5	100	5,99	-





BarEq

Tamper- podstawa; stal nierdzewna
Tamper- base; SS

Nr kat.	Ø cm	PLN	EUR
T-JF23S	5,8	65,55	-



BarEq

Tamper- podstawa; stal nierdzewna
Tamper- base; SS

Nr kat.	Ø cm	PLN	EUR
T-JF23A	5,8	113,91	-



BarEq

Uchwyt do tampera; Al
Tamper handle; Al.

Nr kat.	h cm	PLN	EUR
● T-JF24B	7	65,55	-
● T-JF24C	7	65,55	-

Guma pomiędzy uchwytem a podstawą • Pasują do podstaw:
JF-23A, JF-23S

Rubber between the handle and the base • Fits the bases: JF-23A,
JF-23S



BarEq

Tamper; Al
Tamper; Al.

Nr kat.	Ø cm	PLN	EUR
T-JF22	5,8	122,55	-

BAR
PROFESSIONAL

Tamper; 18/10, drewno
Tamper; 18/10, wood

Nr kat.	Ø cm	PLN	EUR
T-CTH0057	5,8	177,27	-

BAR
PROFESSIONAL

Tamper; Al
Tamper; Al.

Nr kat.	Ø cm	PLN	EUR
T-CTR0057	5,7	133,29	-



BarEq

Miarka; 18/10
Measure; 18/10

Nr kat.	g	PLN	EUR
T-3038	7	23,92	-



BarEq

Podkładka pod kolbę; 18/10, silikon
Tamping support; 18/10, silikon

Nr kat.	l cm	h cm	w cm	PLN	EUR
T-JF05	13	6	9	160,55	-



BarEq

Podkładka pod kolbę; 18/10, silikon
Tamping support; 18/10, silikon

Nr kat.	l cm	h cm	w cm	PLN	EUR
T-JF02	9	7	20	350,55	-

Profil do blatów zaokrąglonych
Profile for rounded tops



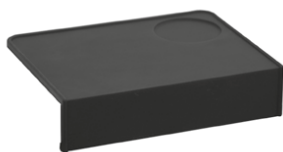

BarEq

Mata do kolby; silikon
Tamping mat; silicone

Nr kat.	l cm	h cm	w cm	PLN	EUR
T-JF04	20	4,5	15	58,81	-

Silikon 3mm • Zagięcie chroniące krawędź stołu
Silicone 3mm • Bend protecting the edge of the table



BarEq

Mata do kolby; silikon
Tamping mat; silicone

Nr kat.	l cm	w cm	PLN	EUR
T-JF03	15	20	32,21	-

Silikon 3 mm • Krawędzie podwyższone do 6 mm
Silicone 3 mm • Elevated edges up to 6 mm



BarEq

Odbijak do kolby; tworzywo
Knockbox; plastic

Nr kat.	Ø cm	h cm	PLN	EUR
● T-JF-09B	10	12	113,05	-
● T-JF29	10	12	113,05	-



Odbijak do kolby; 18/10
Knockbox; 18/10

Nr kat.	l cm	h cm	w cm	PLN	EUR
T-JF30	18,5	12	14	426,55	-



Odbijak do kolby; drewno
Knockbox; wood

Nr kat.	l cm	h cm	w cm	PLN	EUR
T-JF28	14	14	14	113,05	-



BarEq

Odbijak do kolby; drewno, PVC
Knockbox; wood, PVC

Nr kat.	l cm	h cm	w cm	PLN	EUR
T-JF-13B	14	14	14	113,05	-



BarEq

Odbijak do kolby; 18/10
Knockbox; 18/10

Nr kat.	l cm	h cm	w cm	PLN	EUR
T-JF06	30	11	23	778,05	-

Podstawy z gumy zmniejszają hałas i zwiększają stabilność
Rubber bases reduce noise and increase stability



BarEq

Odbijak do kolby; 18/10
Knockbox; 18/10

Nr kat.	l cm	h cm	w cm	PLN	EUR
T-JF-07	27	9	19,5	474,05	-



Odbijak do kolby; 18/10
Knockbox; 18/10

Nr kat.	l cm	h cm	w cm	PLN	EUR
T-JF31	30	9	20	597,55	-



Odbijak do kolby; 18/10
Knockbox; 18/10

Nr kat.	l cm	h cm	w cm	PLN	EUR
T-JF27	17	6	17	398,05	-



Odbijak do kolby; 18/10
Knockbox; 18/10

Nr kat.	l cm	w cm	PLN	EUR
T-JF-10	14	14	113,05	-

Do montażu w blacie
For installation in the worktop

BarEq



Odbijak do kolby; 18/10
Knockbox; 18/10

Nr kat.	l cm	h cm	w cm	PLN	EUR
T-7250	40	9,5	30	527,25	-

KUP ON-LINE





Dzbanek do spieniania mleka; 18/10
Jug for frothing milk; 18/10

Nr kat.	cap l	PLN	EUR
T-205-40	0,4	25,23	-
T-205-060	0,6	32,94	-
T-205-90	0,9	40,38	-

Wewnętrzna miarka
Measure inside



Dzbanek do spieniania mleka biały; 18/10
White jug for frothing milk; 18/10

Nr kat.	h cm	cap l	PLN	EUR
T-105-060W	11,5	0,6	57,55	-

Wewnętrzna miarka
Measure inside



Dzbanek do spieniania mleka czarny; 18/10
Black jug for frothing milk; 18/10

Nr kat.	h cm	cap l	PLN	EUR
T-105-060B	11,5	0,6	52,98	-

Wewnętrzna miarka
Measure inside



Dzbanek do spieniania mleka; 18/10
Jug for frothing milk; 18/10

Nr kat.	h cm	cap l	PLN	EUR
T-10321	8	0,15	14,68	-
T-10421	5,5	0,09	10,98	-



Dzbanek do spieniania mleka; 18/10
Jug for frothing milk; 18/10

Nr kat.	h cm	cap l	PLN	EUR
T-15921	17	2	67,43	-



Dzbanek do spieniania mleka; 18/10
Jug for frothing milk; 18/10

Nr kat.	h cm	cap l	PLN	EUR
T-105-035	9,5	0,35	29,27	-
T-105-060	11,1	0,6	40,01	-
T-105-100	12,5	1	54,90	-
T-105-150	16,2	1,5	66,94	-



BarEq

Termometr do mleka; 18/10
Milk thermometer; 18/10

Nr kat.	Ø cm	l cm	PLN	EUR
T-JF15	3	15	28,50	-

Do dzbanek o pojemnościach 0,3 - 0,6 l • Skala 0°C - 100°C
For jugs 0,3-0,6l • Scale 0°C - 100°C



BarEq

Szczotka do ekspresu; Al, nylon
Brush for coffee machine; Al, nylon

Nr kat.	Ø cm	PLN	EUR
T-JF18	5,6-5,8	65,55	-



BarEq

Szczotka do ekspresu; 18/10, poliamid
Brush for coffee machine; 18/10, polyamide

Nr kat.	Ø cm	l cm	PLN	EUR
T-JF21	1,2	12	12,35	-



BarEq

Pędzel do kolby; drewno, naturalne włosie
Brush for coffee machine; natural bristles

Nr kat.	w cm	PLN	EUR
T-JF20	3,5	31,26	-
T-JF-25	5	28,41	-



BarEq

Szczotka do ekspresu; tworzywo, nylon
Brush for coffee machine; plastic, nylon

Nr kat.	l cm	PLN	EUR
● T-JF19	17	27,93	-
● T-JF26	17	15,96	-





Łyżka do latte
Latte spoon

Nr kat.	l mm	thk mm	op.	PLN	EUR
V-7000-25-12	196	3,5	12	12,26	-



Łyżeczka do herbaty
Tea spoon

Nr kat.	l mm	thk mm	op.	PLN	EUR
V-7000-3-12	144	3,5	12	6,14	-



Łyżeczka do espresso
Espresso spoon

Nr kat.	l mm	thk mm	op.	PLN	EUR
V-7000-26-12	108	3,5	12	5,48	-



Łyżka do latte
Latte spoon

Nr kat.	l mm	thk mm	op.	PLN	EUR
V-6000-25-12	190	3,5	12	8,82	-



Łyżeczka do herbaty
Tea spoon

Nr kat.	l mm	op.	PLN	EUR
V-6000-3-12	145	12	6,25	-



Łyżeczka do espresso
Espresso spoon

Nr kat.	l mm	thk mm	op.	PLN	EUR
V-6000-26-12	118	3,5	12	5,02	-



Łyżka do latte
Latte spoon

Nr kat.	l mm	thk mm	PLN	EUR
V-5000-25-12	205	4,5	9,04	-



Łyżeczka do herbaty
Table spoon

Nr kat.	l mm	thk mm	PLN	EUR
V-5000-3-12	135	4	6,81	-



Łyżeczka do espresso
Espresso spoon

Nr kat.	l mm	thk mm	PLN	EUR
V-5000-26-12	118	3	6,47	-



Łyżka do latte
Latte spoon

Nr kat.	l mm	thk mm	PLN	EUR
V-4000-25-12	203	3,5	7,26	-



Łyżeczka do herbaty
Tea spoon

Nr kat.	l mm	thk mm	PLN	EUR
V-4000-3-12	137	3,5	5,02	-



Łyżeczka do espresso
Espresso spoon

Nr kat.	l mm	thk mm	PLN	EUR
V-4000-26-12	114	3,5	4,80	-





Łyżka do latte; 18/10
Latte spoon; 18/10

Nr kat.	l mm	thk mm	op.	PLN	EUR
E-3010-25-12	208	2,8	12	19,48	-



Łyżka do latte; 18/10
Latte spoon; 18/10

Nr kat.	l mm	thk mm	op.	PLN	EUR
E-2080-25-12	200	3,2	12	24,68	-



Łyżka do herbaty; 18/10
Tea spoon; 18/10

Nr kat.	l mm	thk mm	op.	PLN	EUR
E-964-3-12	140	2	12	6,33	-



Łyżka do herbaty; 18/10
Tea spoon; 18/10

Nr kat.	l mm	thk mm	op.	PLN	EUR
E-2080-3-12	140	2,5	12	6,52	-



Łyżeczka do espresso; 18/10
Espresso spoon; 18/10

Nr kat.	l mm	thk mm	op.	PLN	EUR
E-964-26-12	110	1,8	12	5,84	-



Łyżeczka do espresso; 18/10
Espresso spoon; 18/10

Nr kat.	l mm	thk mm	op.	PLN	EUR
E-2080-26-12	118	2,2	12	5,89	-



Łyżeczka do latte łamana; 18/0
Coffee spoon, dented; 18/0

Nr kat.	l mm	thk mm	PLN	EUR
E-2111731-12	200	2	10,35	-



Łyżeczka do kawy, łamana; 18/0
Coffee spoon, dented; 18/0

Nr kat.	l mm	thk mm	op.	PLN	EUR
E-391059-12	99	2	12	10,97	-





BarEq

Zestaw do latte art; 18/10
Latte art set; 18/10

Nr kat.	Ø cm	l cm	PLN	EUR
T-JF14	1	20	94,91	-

W zestawie 6 funkcjonalnych narzędzi
Set included 6 functional tool



Syfon Kayser; 18/10
Siphon Kayser; 18/10

Nr kat.	cap ml	PLN	EUR
T-BS4051	500	431,00	-
T-BS4101	1000	456,00	-

Rewelacyjna jakość i dopracowanie technologiczne. Niezawodność i wytrzymałość, gwarancja szybkiego, higienicznego i taniego przygotowania naturalnej, lekkiej i puszystej bitej śmietany. W komplecie 2 różne końcówki do dekoracji. Śmietana pozostaje w syfonie świeża 10 dni, jeśli jest przechowywana w niskiej temp. i bez dopływu powietrza.



Naboje do syfonu (kpl. 10szt.)
Cartridges for siphon (10 pcs)

Nr kat.	PLN	EUR
T-BSN-1111	25,00	-



Filizanka
Cup

Nr kat.	Ø cm	cap ml	op.	PLN	EUR
R-MECU35-12	9,9	350	12	32,60	-



Filizanka
Cup

Nr kat.	Ø cm	cap ml	op.	PLN	EUR
R-MECU09-12	5,4	90	12	17,55	-
R-MECU20-12	7,8	200	12	26,33	-



Spodek do filizanki
Espresso saucer

Nr kat.	Ø cm	op.	PLN	EUR
R-MESA13-12	13	12	16,30	-
R-MESA15-12	15	12	18,81	-
R-MESA17-12	17	12	22,57	-



KUP ON-LINE





Filiżanka
Cup

Nr kat.	h cm	cap ml	op.	PLN	EUR
R-116CU20-12	6	200	12	23,61	-
R-116CU23-12	6,1	230	12	23,61	-
R-116CU28-12	6,3	280	12	24,85	-
R-116CU37-12	6,7	370	12	27,34	-
R-116CU45-12	7,5	450	12	37,28	-



R-CLSA01-12

R-CLSA02-12

Spodek uniwersalny
Universal saucer

Nr kat.	Ø cm	op.	PLN	EUR
R-CLSA01-12	15,7	12	17,55	-
R-CLSA02-12	17	12	18,81	-



Spodek do espresso
Espresso saucer

Nr kat.	Ø cm	op.	PLN	EUR
R-CLSA13-12	13	12	15,05	-



Filiżanka do espresso
Espresso cup

Nr kat.	h cm	cap ml	op.	PLN	EUR
R-116CU08-12	5,3	80	12	16,15	-



Uniwersalny spodek do filiżanki
Saucer

Nr kat.	l cm	w cm	op.	PLN	EUR
R-SPRP24IN-6	24	14	6	85,27	-

Spodek posiada trzyna walebienia o średnicy 5 cm; 6,7 cm oraz 9 cm.



Filiżanka
Cup

Nr kat.	Ø cm	h cm	cap ml	op.	PLN	EUR
R-KR116CU20-12	8,7	6	200	12	41,38	-
R-KR116CU23-12	9	6,1	230	12	46,39	-



Filiżanka do espresso
Espresso cup

Nr kat.	Ø cm	h cm	cap ml	op.	PLN	EUR
R-KR116CU08-12	6,5	5,3	80	12	27,59	-



Spodek do filiżanki
Saucer

Nr kat.	Ø cm	op.	PLN	EUR
R-KRCLSA02-12	17	12	35,11	-
R-KRCLSA13-12	13	12	23,83	-



Więcej filiżanek/kubków w dziale PORCELANA I DODATKI STOŁOWE

See more cups in PORCELAIN & TABLEWARE section





N

Sentido

Nr kat.	Ø mm	h mm	cap ml	kosz	op.	PLN	EUR
ON-21066VCH08-12	75	75	80	305318	12	8,74	-
ON-21066VCN22-6	108	89	220	165318	6	10,40	-
ON-21066VCN37-6	126	111	370	95434	6	12,16	-
ON-21066VCN26-6	111	143	260	95638	6	12,16	-



N

Country

Nr kat.	Ø mm	h mm	cap ml	kosz	op.	PLN	EUR
ON-2291VCN24-6	104	147	225	165534	6	9,96	-



Bill

Nr kat.	Ø cm	h cm	cap ml	kosz	op.	PLN	EUR
ON-2264VCN24-6 (LB-920338-12)	7,7	14,6	225	165534	6	10,14	-



Mini Bill

Nr kat.	Ø cm	h cm	cap ml	kosz	op.	PLN	EUR
ON-2264VCN12-6 (LB-2264FCN-12)	6	11	120	255434	6	9,56	-



N

Acapulco

Nr kat.	Ø mm	h mm	cap ml	kosz	op.	PLN	EUR
ON-2783VCH08-12	59	65	80	365318	12	8,88	-
ON-2609VCN18-6	75	81	180	305318	6	9,36	-



Acapulco

Nr kat.	Ø cm	h cm	cap ml	kosz	op.	PLN	EUR
ON-2302VCN28-6 (LB-920314-12)	7,8	15	285	305638	6	9,48	-



Endeavor

Nr kat.	Ø cm	h cm	cap ml	kosz	op.	PLN	EUR
ON-15733-12 (LB-15733-12)	6,9	7,6	110	365318	12	7,96	-



Endeavor

Nr kat.	Ø cm	h cm	cap ml	kosz	op.	PLN	EUR
ON-15711-12 (LB-15711-12)	7	15,9	295	365638	12	9,05	-

KUP ON-LINE



OUTLET

sprzedaż do wyczerpania
zapasów

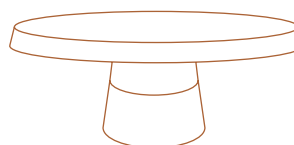
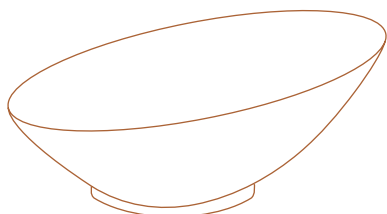
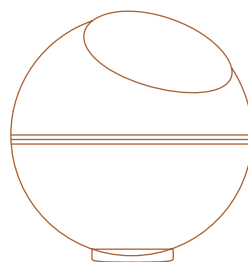
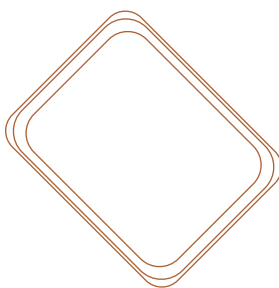
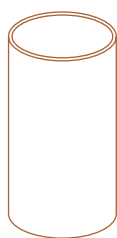



Abella bluzka, krótki rękaw

Nr kat.	kolor	PLN	EUR
U-AB-WTS-XS	czarny	139,00	-
U-AB-WTS-S	czarny	139,00	-
U-AB-WTS-M	czarny	139,00	-
U-AB-WTS-L	czarny	139,00	-
U-AB-WTS-XL	czarny	139,00	-
U-AB-WTS-XXL	czarny	139,00	-

Polibawełna 160 g/m² (50% poliester, 50% bawełna), połączenie najwyższej jakości bawełny z elegancką fakturą „krateczki” i unikalnej, oddychającej tkaniny po bokach • Stójka podszyta wewnątrz miękką tkaniną • Ukryte zatrzaski • Kieszeń na rękawie • Rozcięcia po bokach



Unera, bluzka krótki rękaw

Nr kat.	kolor	PLN	EUR
U-UN-BTS-XXXL	czarny	89,00	-

Polibawełna 195 g/m² • Ukryte zatrzaski • Kieszeń na rękawie



Unera, bluzka krótki rękaw

Nr kat.	kolor	PLN	EUR
U-UN-GTS-XXXL	antracyt	89,00	-

Polibawełna 195 g/m² • Ukryte zatrzaski • Kieszeń na rękawie



Vemax, bluzka krótki rękaw

Nr kat.	kolor	PLN	EUR
U-VM-WTS-XS	biały	109,00	-
U-VM-WTS-S	biały	109,00	-
U-VM-WTS-M	biały	109,00	-
U-VM-WTS-XXL	biały	109,00	-
U-VM-WTS-XXXL	biały	109,00	-

Polibawełna 195 g/m² + nowoczesne włókno X-Static® z warstwą czystego srebra (właściwości antybakteryjne, termoregulacyjne i antystatyczne) • Usztywniona stójka • Ukryte zatrzaski • Przędź asymetryczny • Wywinięte rękawy • Kieszeń na piersi • Rozcięcia po bokach



Usti, bluzka długi rękaw

Nr kat.	kolor	PLN	EUR
U-US-WLS-L	biały	119,00	-
U-US-WLS-XL	biały	119,00	-
U-US-WLS-XXL	biały	119,00	-

Polibawełna ze strezczem 200 g/m² • Ukryte zatrzaski • Kieszeń na rękawie • Rozcięcia po bokach



Monblanc, bluzka długi rękaw

Nr kat.	kolor	PLN	EUR
U-MO-WLS-XS	biały	239,00	-
U-MO-WLS-S	biały	239,00	-
U-MO-WLS-XXL	biały	239,00	-

100% Bawełna 185 g/m² • Obszyte guziki • Zapięcie na dwie strony • Rozcięcia po bokach • Kieszeń na piersi i na ramieniu



Valto, bluzka długi rękaw

Nr kat.	kolor	PLN	EUR
U-VL-WLS-XS	biały	129,00	-
U-VL-WLS-S	biały	129,00	-
U-VL-WLS-XXL	biały	129,00	-

Poliester Tencel 195 g/m² • Ukryte zatrzaski • Rękawy z efektem spinki • Kieszeń na ramieniu



Bluzka Moscow

Nr kat.	rękaw	kolor	PLN	EUR
U-MO-XXXL	długi	biały	159,00	-

Tkanina: 65 % poliester, 35 % bawełna • Ocieplana



Teja bluzka, długi rękaw

Nr kat.	rękaw	kolor	PLN	EUR
U-TE-WLS-XS	długi	biały	109,00	-
U-TE-WLS-S	długi	biały	109,00	-
U-TE-WLS-XXL	długi	biały	109,00	-

Tkanina: 49 % poliester, 49 % bawełna, 2 % jedwab

**SAVOYE, biała, długi rękaw, rozm. XXXL**

Nr kat.	rękaw	kolor	PLN	EUR
U-SA-WLS-XXXL	długi	biały	149,00	-

Tkanina: 100 % bawełna

**Trendy bluza, rozm. XXL**

Nr kat.	rękaw	kolor	PLN	EUR
U-TR-WLS-XXL	długi	biały	69,00	-

Tkanina: Lekka i miękka 210 g/m, lecz wytrzymała, nieprzemakalna i nie przysysająca plam (można je słucać) • Oddychający dżersej na plecach dla komfortu termicznego

**Vego, bluza długi rękaw**

Nr kat.	kolor	PLN	EUR
U-VG-WLS-XS	biały	119,00	-
U-VG-WLS-S	biały	119,00	-
U-VG-WLS-M	biały	119,00	-
U-VG-WLS-L	biały	119,00	-

Polibawełna 140 g/m2 (60% bawełna, 40% poliester) • Ukryte zatrzaski • Kontrfałda na plecach • Rozcięcia po bokach • Kieszeń na ramieniu

**Adagio bluza, długi rękaw**

Nr kat.	kolor	PLN	EUR
U-AD-WLS-XS	biały	119,00	-
U-AD-WLS-S	biały	119,00	-
U-AD-WLS-M	biały	119,00	-
U-AD-WLS-L	biały	119,00	-

Polibawełna ze streczem 200 g/m2 • Frotowa wyściółka stójki • Ukryte zatrzaski • Kieszeń na rękawie • Centralne rozpięcie • Boki w tkaninie Sofidry®

**Ummy, biała, długi rękaw**

Nr kat.	kolor	PLN	EUR
U-UM-WLS-XS	biały	79,00	-
U-UM-WLS-L	biały	79,00	-
U-UM-WLS-XL	biały	79,00	-

Tkanina: Polibawełna 215 g/m2 (65% poliester, 35% bawełna) • Oddychająca tkanina dżersejowa po bokach dla komfortu termicznego

**Energy, bluza długi rękaw**

Nr kat.	kolor	PLN	EUR
U-EN-RLS-XS	czerwona	79,00	-
U-EN-RLS-S	czerwona	79,00	-
U-EN-RLS-M	czerwona	79,00	-
U-EN-RLS-L	czerwona	79,00	-
U-EN-RLS-XL	czerwona	79,00	-
U-EN-RLS-XXL	czerwona	79,00	-

Polibawełna 215 g/m2 • Oddychająca tkanina dżersejowa po bokach dla komfortu termicznego • Ukryte zatrzaski • Kieszeń na piersi i rękawie

**Vintage, bluza długi rękaw**

Nr kat.	kolor	PLN	EUR
U-VT-NLS-XS	biało-niebieska	99,00	-

Polibawełna 195 g/m2, rękawy z dzianinowej bawełny Natura • Kieszeń na ramieniu

**Vintage, bluza długi rękaw**

Nr kat.	kolor	PLN	EUR
U-VT-BLS-S	biało-czarna	99,00	-

Polibawełna 195 g/m2, rękawy z dzianinowej bawełny Natura • Kieszeń na ramieniu

**Vulby, bluza długi rękaw**

Nr kat.	kolor	PLN	EUR
U-VB-GLS-XS	biało-szary	109,00	-
U-VB-GLS-S	biało-szary	109,00	-
U-VB-GLS-M	biało-szary	109,00	-
U-VB-GLS-XXL	biało-szary	109,00	-

Polibawełna 195 g/m2 • Ukryte zatrzaski • Kieszonka na rękawie • Rozcięcia po bokach • Można prać przemysłowo

KUP ON-LINE





Briva, bluzka długi rękaw

Nr kat.	kolor	PLN	EUR
U-BI-JLS-XS	batyst	129,00	-
U-BI-JLS-S	batyst	129,00	-
U-BI-JLS-M	batyst	129,00	-
U-BI-JLS-L	batyst	129,00	-
U-BI-JLS-XL	batyst	129,00	-
U-BI-JLS-XXL	batyst	129,00	-

100% Bawełna • Zatraski w kolorze mosiądzu • Listwa z zatraskami, stójka i mankiety od wewnątrz oraz przeszycia w kontrastowym kolorze granatowym



Abella bluzka, długi rękaw

Nr kat.	kolor	PLN	EUR
U-AB-BLS-XS	czarny	139,00	-
U-AB-BLS-M	czarny	139,00	-
U-AB-BLS-L	czarny	139,00	-

Polibawełna 160 g/m2 (50% poliester, 50% bawełna), połączenie najwyższej jakości bawełny z elegancką fakturą „krateczki” i unikalnej, oddychającej tkaniny po bokach • Stójka podszyta wewnątrz miękką tkaniną • Ukryte zatraski • Kieszeń na rękawie • Rozcięcia po bokach



Expression, bluzka długi rękaw

Nr kat.	kolor	PLN	EUR
U-EX-BLS-L	czarny / fuksja	89,00	-
U-EX-BLS-XL	czarny / fuksja	89,00	-
U-EX-BLS-XXL	czarny / fuksja	89,00	-

Polibawełna 215 g/m2 (czarny kolor - 195 g/m2) • Oddychająca tkanina dżersejowa po bokach dla komfortu termicznego • Ukryte zatraski • Kieszeń na piersi i rękawie



Vador, bluzka długi rękaw

Nr kat.	kolor	PLN	EUR
U-VD-BLS-XS	czarny	129,00	-
U-VD-BLS-S	czarny	129,00	-
U-VD-BLS-L	czarny	129,00	-
U-VD-BLS-XL	czarny	129,00	-
U-VD-BLS-XXL	czarny	129,00	-

Polibawełna 195 g/m2, plecy tkanina ze srebrem • Ukryte zatraski • Kieszeń na piersi na telefon • Kieszeń na ramieniu • Rozcięcia po bokach



Abax, bluzka długi rękaw

Nr kat.	kolor	PLN	EUR
U-AX-MLS-XS	mokka	99,00	-
U-AX-MLS-M	mokka	99,00	-
U-AX-MLS-XL	mokka	99,00	-
U-AX-MLS-XXL	mokka	99,00	-
U-AX-MLS-XXXL	mokka	99,00	-

Polibawełna 215g/m2 • Stójka • Ukryte zatraski • Kontrastowe przeszycia: stójka + ramiona + plecy + mankiety • Wstawka z oddychającej tkaniny



Hawaii - Pas sommelierski na akcesoria

Nr kat.	kolor	PLN	EUR
U-HA-B-S	czarny	89,00	-
U-HA-B-M	czarny	89,00	-
U-HA-B-L	czarny	89,00	-

Polibawełna • Zwężany • 6 kieszeni • Elastyczny, szeroki na 8 cm pas • Klamry ze stali nierdzewnej



GARNKI I PATELNIE

TOMGAST



TOMGAST



TOMGAST



Garnek wysoki SILVER; 18/10

Nr kat.	Ø cm	h cm	cap l	PLN	EUR
P2-2101-20	20	17	5	119,00	-
P2-2101-28	28	24	14	199,00	-
P2-2101-32	32	27	20,5	299,00	-



Garnek średni SILVER; 18/10

Nr kat.	Ø cm	h cm	cap l	PLN	EUR
P2-2107-20	20	12,5	4	89,00	-
P2-2107-24	24	15	6,5	119,00	-
P2-2107-28	28	17	10	159,00	-
P2-2107-32	32	19,5	14	239,00	-



Garnek niski SILVER; 18/10

Nr kat.	Ø cm	h cm	cap l	PLN	EUR
P2-2109-20	20	9	2,5	89,00	-
P2-2109-24	24	10,5	4,5	119,00	-
P2-2109-28	28	12	7	159,00	-



POJEMNIKI GASTRONOMICZNE

TOMGAST



Pojemnik GN 1/1; 18/10

Nr kat.	l cm	h cm	w cm	cap l	PLN	EUR
IT-11020	53	2	32,5	2,5	49,00	-

Pokrywa GN 1/1 z wycięciem na łyżkę; 18/10

Nr kat.	l cm	w cm	PLN	EUR
IT-11001L	53	32,5	59,00	-
IT-11001S	53	32,5	89,00	-



TOMGAST



Pojemnik GN 1/2 z uchwytami; 18/10

Nr kat.	l cm	h cm	w cm	cap l	PLN	EUR
IT-12200U	26,5	20	32,5	12,5	79,00	-

Pokrywa GN 1/2 z wycięciem na uchwyt i uszczelką; 18/10

Nr kat.	l cm	w cm	PLN	EUR
IT-12001US	26,5	32,5	79,00	-



TOMGAST



Pojemnik GN 1/4 z uchwytami; 18/10

Nr kat.	l cm	h cm	w cm	cap l	PLN	EUR
IT-14200U	16,2	20	26,5	5,5	29,00	-

Pokrywa GN 1/4 z wycięciem na uchwyt; 18/10

Nr kat.	l cm	w cm	PLN	EUR
IT-14001U	16,2	26,5	10,00	-
IT-14001US	16,2	26,5	19,00	-



TOMGAST



Pojemnik GN 1/6 z uchwytami; 18/10

Nr kat.	l cm	h cm	w cm	cap l	PLN	EUR
IT-16150U	16,2	15	17,6	2,4	39,00	-

Pokrywa GN 1/6 z wycięciem na uchwyt; 18/10

Nr kat.	l cm	w cm	PLN	EUR
IT-16001U	16,2	17,6	14,00	-
IT-16001US	16,2	17,6	39,00	-



KUP ON-LINE



TOMGAST



Pojemnik GN 2/3 z uchwytami; 18/10

Nr kat.	l cm	h cm	w cm	cap l	PLN	EUR
IT-23200U	32,5	20	35,4	18	69,00	-

Pokrywa GN 2/3 z wycięciem na uchwyt i uszczelką; 18/10

Nr kat.	l cm	w cm	PLN	EUR
IT-23001US	32,5	35,4	49,00	-



TOMGAST



Pojemnik GN z uchwytami i pokrywą

Nr kat.	GN	l cm	h cm	w cm	cap l	PLN	EUR
IT-11200U-POK	1/1	53	20	32,5	28	159,00	-
IT-12150U-POK	1/2	32,5	15	26,5	9,5	79,00	-
IT-13100U-POK	1/3	32,5	10	17,5	4	49,00	-

Stal nierdzewna • Pokrywa z wycięciem na uchwyty

TOMGAST



Pojemnik GN z uchwytami i pokrywą

Nr kat.	GN	l cm	h cm	w cm	cap l	PLN	EUR
IT-12200U-POKSIL	1/2	32,5	20	26,5	12,5	159,00	-
IT-13200U-POKSIL	1/3	32,5	20	17,5	7,8	109,00	-

Stal nierdzewna • Pokrywa z wycięciem na uchwyty i uszczelką silikonową

TOMGAST



Pojemnik GN 1/1 z uchwytami; 18/10

Nr kat.	l cm	h cm	w cm	cap l	PLN	EUR
IT-11150U	53	15	32,5	21	109,00	-
IT-11200U	53	20	32,5	28	129,00	-



TOMGAST



Pojemnik GN z pokrywą

Nr kat.	GN	l cm	h cm	w cm	cap l	PLN	EUR
IT-11150-POKSIL	1/1	53	15	32,5	21	199,00	-
IT-12065-POKSIL	1/2	32,5	6,5	26,5	4	109,00	-
IT-12150-POKSIL	1/2	32,5	15	26,5	9,5	119,00	-
IT-12200-POKSIL	1/2	32,5	20	26,5	12,5	129,00	-
IT-13100-POKSIL	1/3	32,5	10	17,5	4	89,00	-
IT-14150-POKSIL	1/4	26,5	15	16,2	4	85,00	-
IT-16100-POKSIL	1/6	16,2	10	17,6	1,6	69,00	-
IT-23150-POKSIL	2/3	35,4	15	32,5	13	159,00	-
IT-23200-POKSIL	2/3	35,4	20	32,5	18	169,00	-

Stal nierdzewna • Pokrywa z uszczelką silikonową

TOMGAST



Pojemnik GN z pokrywą

Nr kat.	GN	l cm	h cm	w cm	cap l	PLN	EUR
IT-14150-POK	1/4	26,5	15	16,2	4	59,00	-
IT-19100-POK	1/9	17,6	10	10,8	0,8	55,00	-

Stal nierdzewna • Pokrywa standardowa



POJEMNIKI GASTRONOMICZNE

TOMGAST



Pojemnik GN 2/3; 18/10

Nr kat.	l cm	h cm	w cm	cap l	PLN	EUR
IT-23040	32,5	4	35,4	3	39,00	-
IT-23065	32,5	6,5	35,4	5,5	45,00	-
IT-23100	32,5	10	35,4	9	59,00	-

Pokrywa GN 2/3 z wycięciem na łyżkę; 18/10

Nr kat.	l cm	w cm	PLN	EUR
IT-23001L	32,5	35,4	29,00	-



TOMGAST



Pojemnik GN 2/4; 18/10

Nr kat.	l cm	h cm	w cm	cap l	PLN	EUR
IT-24100	53	10	16,2	5,8	49,00	-

Pokrywa GN 2/4; 18/10

Nr kat.	l cm	w cm	PLN	EUR
IT-24001	53	16,2	19,00	-



TOMGAST



Pojemnik GN 2/3 z pokrywą

Nr kat.	l cm	h cm	w cm	cap l	PLN	EUR
IT-23065L-POK	35,4	6,5	32,5	5,5	69,00	-

Stal nierdzewna • Pokrywa z wycięciem na łyżkę

TOMGAST



Pojemnik GN 1/3; 18/10

Nr kat.	l cm	h cm	w cm	cap l	PLN	EUR
IT-13020	17,5	2	32,5	0,7	25,00	-
IT-13100	17,5	10	32,5	4	39,00	-
IT-13200	17,5	20	32,5	7,8	79,00	-



TOMGAST



Pojemnik GN 1/4; 18/10

Nr kat.	l cm	h cm	w cm	cap l	PLN	EUR
IT-14065	16,2	6,5	26,5	1,8	25,00	-
IT-14150	16,2	15	26,5	4	49,00	-



TOMGAST



Pojemnik GN 2/1; 18/10

Nr kat.	l cm	h cm	w cm	cap l	PLN	EUR
IT-21040	65	4	53	10	99,00	-
IT-21065	65	6,5	53	19	149,00	-
IT-21100	65	10	53	31	159,00	-
IT-21150	65	15	53	42,5	199,00	-



TOMGAST



Pojemnik GN 2/3 perforowany; 18/10

Nr kat.	l cm	h cm	w cm	cap l	PLN	EUR
IT-23100P	32,5	10	35,4	9	39,00	-



TOMGAST



Pokrywa GN 1/6 z wycięciem na łyżkę; 18/10

Nr kat.	l cm	w cm	PLN	EUR
IT-16001L	16,2	17,6	15,00	-



TOMGAST



Pokrywa GN 1/2 z uszczelką silikonową; 18/10

Nr kat.	l cm	w cm	PLN	EUR
IT-12001S	26,5	32,5	69,00	-



KUP ON-LINE





Pojemnik HACCP GN 1/1 PP

Nr kat.	l cm	h cm	w cm	cap l	PLN	EUR
HR-11100	53	10	32,5	13,3	29,00	-
HR-11150	53	15	32,5	20	32,00	-
HR-11200	53	20	32,5	26,4	39,00	-



Pojemnik HACCP 1/2 PP

Nr kat.	l cm	h cm	w cm	cap l	PLN	EUR
HR-12100	26,5	10	32,5	6,1	15,00	-



Pojemnik HACCP GN 1/3 PP

Nr kat.	l cm	h cm	w cm	cap l	PLN	EUR
HR-13065	17,5	6,5	32,5	2,5	9,00	-
HR-13100	17,5	10	32,5	3,8	12,00	-

Pokrywa szczelna GN 1/3; PP

Nr kat.	l cm	w cm	PLN	EUR
MP-13001	17,5	32,5	5,00	-



Pojemnik HACCP GN 1/4 PP

Nr kat.	l cm	h cm	w cm	cap l	PLN	EUR
HR-14065	16,2	6,5	26,5	1,7	8,00	-
HR-14100	16,2	10	26,5	2,6	10,00	-



Pojemnik HACCP GN 1/6 PP

Nr kat.	l cm	h cm	w cm	cap l	PLN	EUR
HR-16065	16,2	6,5	17,6	1	7,00	-
HR-16100	16,2	10	17,6	1,6	8,00	-
HR-16150	16,2	15	17,6	2,3	9,00	-



100%Chef

Słoik Jogurt Pot (36 szt)

Nr kat.	Ø cm	h cm	cap ml	op.	PLN	EUR
C1-100-0052	7	10	400	36	159,00	-



Range pojemnik GN 1/1 - 150 z poliwęglanu

Nr kat.	l cm	h cm	w cm	cap l	PLN	EUR
M2-11150	53	15	32,5	21	29,00	-



Pojemnik GN 1/6 z polipropylenu

Nr kat.	l cm	h cm	w cm	cap l	PLN	EUR
MP-16065	16,2	6,5	17,6	1	5,00	-



Pojemnik GN 1/6 - 100 z polipropylenu

Nr kat.	l cm	h cm	w cm	cap l	PLN	EUR
MP-16100	16,2	10	17,6	1,6	4,00	-



CAMBRO



Range pojemnik GN 1/6 - 150 z poliwęglanu

Nr kat.	l cm	h cm	w cm	cap l	PLN	EUR
M2-16150	16,2	15	17,6	2,4	7,00	-



Pokrywa szczelna GN 1/9; PP

Nr kat.	l cm	w cm	PLN	EUR
MP-19001	10,8	17,6	3,00	-



Pokrywa 1/2 z poliwęglanu z otworem na łyżkę

Nr kat.	l cm	w cm	PLN	EUR
CM-20CWCHN135	26,5	32,5	12,00	-

CAMBRO

CAMBRO



Range pojemnik GN 1/6 z poliwęglanu czarny

Nr kat.	l cm	h cm	w cm	cap l	PLN	EUR
M2-16150B	16,2	15	17,6	2,4	8,00	-



Pojemnik z poliwęglanu Camwear® GN 2/4

Nr kat.	l cm	w cm	cap l	op.	PLN	EUR
CM-22LPCW110	53	16,2	3	6	22,00	-



Pojemnik 2/4 z poliwęglanu czarny

Nr kat.	l cm	w cm	cap l	op.	PLN	EUR
CM-24LPCW110	53	16,2	5	6	28,00	-



Range pojemnik GN 1/1 z poliwęglanu czarny

Nr kat.	l cm	h cm	w cm	cap l	PLN	EUR
M2-11150B	53	15	32,5	21	29,00	-



Pojemnik z poliwęglanu 1/2 czarny

Nr kat.	l cm	h cm	w cm	cap l	PLN	EUR
M2-12200B	26,5	20	32,5	12,5	19,00	-



Pokrywa z poliwęglanu 1/2 czarna

Nr kat.	l cm	w cm	PLN	EUR
M2-12001B	32,5	26,5	7,00	-



Klipsy na pokrywki

Nr kat.	col	PLN	EUR
HR-BLU	niebieski	1,00	-
HR-RED	czerwony	1,00	-
HR-VER	zielony	1,00	-

CAMBRO



Pokrywa szczelna; PP

Nr kat.	PLN	EUR
CM-RFSC12PP do pojemników 0,9 l	12,00	-



Pokrywa do sita bambusowego

Nr kat.	Ø cm	h cm	PLN	EUR
T-PD-552	15	3,5	10,00	-
T-PD-553	20	4	11,00	-



KUP ON-LINE

TRAMONTINA



Łopata ząbkowane krawędzie
dł. 48 cm / TRAMONTINA

Nr kat.	l cm	PLN	EUR
TR-4200	ząbkowana 48	15,00	-

TRAMONTINA

TRAMONTINA



Szufelka dł. 64 cm

Nr kat.	l cm	PLN	EUR
TR-7075	64	49,00	-

TRAMONTINA

TRAMONTINA



Skrobka dł. 72 cm

Nr kat.	l cm	PLN	EUR
TR-7175	72	49,00	-

TRAMONTINA



Nóż gładkie ostrze dł. 45,8 cm

Nr kat.	l cm	PLN	EUR
TR-4407	45,8	12,00	-

Uchwyt: drewno z aluminiowymi nitami • Nie można myć w zmywarce

TRAMONTINA



Podwójny szpikulec z drewnianym
uchwytem dł. 65 cm

Nr kat.	l cm	PLN	EUR
TR-2765	65	15,00	-
TR-2785	85	17,00	-

Nóż ząbkowane ostrze dł. 47,6 cm

Nr kat.	l cm	PLN	EUR
TR-4008	47,6	10,00	-

Uchwyt: drewno z aluminiowymi nitami • Nie można myć w zmywarce



Szpikulec dł. 50 cm (6szt.) / TRAMONTINA

Nr kat.	l cm	PLN	EUR
TR-9906	50	19,00	-

CAMBRO



Ubiak do ziemniaków - stal nierdzewna

Nr kat.	l cm	PLN	EUR
VC-41305PM	35,5	13,00	-

Nóż do sera

Nr kat.	l cm	PLN	EUR
W-MGB08	22,5	3,00	-



Łyżka z poliwęglanu perforowana czarna

Nr kat.	l cm	w cm	PLN	EUR
CM-SPOP11CW110	28,3	7,3	6,00	-



Łyżka z poliamidu 37,5 cm

Nr kat.	l cm	PLN	EUR
NP-8238	37,5	10,00	-



Łopata do pizzy prostokątna,
perf. - aluminium 180

Nr kat.	l cm	w cm	PLN	EUR
MG-A45RF180	230	45	339,00	-

Perforowana • Długość uchwyty





Vitamix Drink Machine Two-Speed blender

Nr kat.	l cm	h cm	w cm	cap l	W	obr./m	PLN	EUR
VX-DM1	23	44	20	1,4	1200	32000	2 999,00	-

Przycisk przełączania między dwoma prędkościami



Przystawka do pappardelle zębowanego 12 mm

Nr kat.	PLN	EUR
T-IM098	239,00	-

Do makaroniarki Imperia T-IM010



100%Chef

Macarron Kit; 18/0

Nr kat.	l cm	w cm	PLN	EUR
C1-5001	20	14	99,00	-



Tarcza do kostek; stal nierdzewna

Nr kat.	PLN	EUR
DY-CL4010	499,00	-

Tarcza do szatkownicy BLEND & MIX



Tarcza do frytek; stal nierdzewna

Nr kat.	PLN	EUR
DY-CL5008	499,00	-

Tarcza do szatkownicy BLEND & MIX

URZĄDZENIA I KUCHNIA NOWOCZESNA

OUTLET



100%Chef

Worki coctail (1000 szt.) - bio polipropylen

Nr kat.	Ø cm	h cm	op.	PLN	EUR
C1-100-0151	80	24	1000	259,00	-



Vacoock - kulki do sous vide; polipropylen nietoksyczny

Nr kat.	Ø cm	g	op.	PLN	EUR
BV-01	7,5	1	500	259,00	-



100%Chef

Szpila- kość; porcelana

Nr kat.	l cm	h cm	w cm	op.	PLN	EUR
C1-2120	18	1	2	3	99,00	-

Replika kości wykonana z porcelany



Koszyk do serwowania; 18/10, PVD

Nr kat.	Ø cm	h cm	PLN	EUR
TF-602	8	7,5	29,00	-

CUKIERNICTWO

de Buyer



Rant cukierniczy perforowany Expert; 18/10

Nr kat.	PLN	EUR
D-3099-84	79,00	-

Drobna perforacja daje efekt jednolitego pieczenia i karmelizacji



Forma do babek - powłoka ceramiczno-silikonową

Nr kat.	Ø cm	h cm	cap l	PLN	EUR
S-12-014	14	5	0,25	19,00	-

KUP ON-LINE



de Buyer



Blacha do pieczenia perforowana; Al

Nr kat.	l cm	w cm	thk mm	PLN	EUR
D-7368-53	53	32,5	1,5	69,00	-

de Buyer



Worek cukierniczy silikonowy

Nr kat.	l cm	w cm	PLN	EUR
D-4347-50	50	28	69,00	-

Zwiększona wytrzymałość, giętkość i miękkość materiału • Wewnątrz śliski dla łatwiejszego wyciskania, na zewnątrz szorstki dla pewniejszego chwytu • Do temperatury maks. 60°C

de Buyer



Worki cukiernicze jednorazowe; PE

Nr kat.	l cm	cap l	PLN	EUR
D-4348-30	30	0,25	59,00	-

Rolka zawiera 100 worków • Do temperatury maks. 70°C



Końcówka stalowa okrągła

Nr kat.	Ø cm	PLN	EUR
S-56-502	4	4,00	-

de Buyer



Podstawa pod misę do miksowania; 18/10

Nr kat.	Ø cm	PLN	EUR
D-3379-01	13,5	49,00	-

Pasuje do mis o śr.: 30-45 cm



Patera; 18/10

Nr kat.	Ø cm	h cm	PLN	EUR
T-53-003	20/22,5/25	40	280,25	-

KUP ON-LINE



CATERING

OUTLET



Pokrowiec na stół okrągły ecru

Nr kat.	Ø cm	col	PLN	EUR
BTO-0180-E	180	ecru	59,00	-

poliester 94%, elastan 6%



Verlo

Pokrowiec na stół; poliester 94%, elastan 6%

Nr kat.	Ø cm	col	PLN	EUR
V-C80-C	81	turkusowy	69,00	-



Norman pokrowiec na krzesło biały

Nr kat.	col	PLN	EUR
BTO-KN-W	biały	25,00	-

poliester 94%, elastan 6%

CAMBRO



Wózek; PP

Nr kat.	l cm	h cm	w cm	PLN	EUR
CM-CD100	73	27	50	799,00	-
CM-CD300	65	26,5	49	799,00	-

CD 100 - do wszystkich termosów oprócz UC1000CD 300
- do UC1000

Termos na pojemniki GN o głębokości 200mm

Nr kat.	l cm	h cm	w cm	kg	PLN	EUR
CAT-349	37	30,8	63	6,3	299,00	-



Wózek na krzesła Alex

Nr kat.	l cm	h cm	w cm	PLN	EUR
RA-104A	95,4	196,8	47,5	499,00	-

BUFET I DODATKI STOŁOWE



White Gold talerz płaski prostokątny

Nr kat.	l cm	w cm	PLN	EUR
R-GDRT42-6	42	32,5	39,00	-



Minimax taca serwisowa

Nr kat.	l cm	w cm	PLN	EUR
R-LXST39-6	39	28	49,00	-



Massilia talerz kwadratowy

Nr kat.	l cm	w cm	op.	PLN	EUR
R-MSSIN22-12	20	20	12	19,00	-



Mazza talerz głęboki podwójny

Nr kat.	l cm	h cm	w cm	op.	PLN	EUR
R-MZTP32-6	32,5	3,5	10	6	29,00	-
R-MZTW53-6	53,3	5,5	30,4	6	49,00	-



Półmisek

Nr kat.	l cm	w cm	cap ml	op.	PLN	EUR
R-BUOV36-2	36	22	1360	2	79,00	-

abert

abert



Półmisek głęboki; 18/10

Nr kat.	l cm	h cm	w cm	PLN	EUR
T-5055	55	3	24	39,00	-

Rant wyskopolowany, dno satynowane



Miseczka stal nierdzewna

Nr kat.	l cm	w cm	PLN	EUR
AB-0505	18,5	18,5	45,00	-



Talerz; plexiglass

Nr kat.	l cm	w cm	PLN	EUR
AB-871-3	30	30	99,00	-

CAMBRO

CAMBRO



Półmisek Showfest ośmiokątny czarny

Nr kat.	l cm	h cm	w cm	cap l	op.	PLN	EUR
CM-SFG820110	50,8	5	20,3	3,7	6	30,00	-

Ośmiokątny



Naczynie ośmiokątne czarne

Nr kat.	l cm	h cm	w cm	cap ml	PLN	EUR
CM-SFG1012110	30,5	5	25,4	2800	22,00	-

Verlo

Verlo



Talerz prezentacyjny; żywica

Nr kat.	l cm	h cm	w cm	col	PLN	EUR
V-3015-G	30	1,8	15	szary	49,00	-
V-3015-O	30	1,8	15	pomarańczowy	49,00	-
V-3015-R	30	1,8	15	czerwony	49,00	-
V-3015-T	30	1,8	15	turkusowy	49,00	-



Panel i pokrywa GN

Nr kat.	l cm	h cm	w cm	col	PLN	EUR	
V-61300-L	<i>pokrywa</i>	32,5	10	18,3	przezroczysty	29,00	-
V-61305	<i>panel</i>	32,5	1	17,6	szary	29,00	-

KUP ON-LINE



Verlo



Podgrzewacz GN 1/1 z podstawą; 18/10

Nr kat.	l cm	h cm	w cm	cap l	PLN	EUR
V-1100-06	75	35	50	9	1 399,00	-

Pokrywa z hydraulicznym systemem hamującym • Nienagrzewający się uchwyt pokrywy • Teleskopy dla łatwego i bezpiecznego sztaplowania • Specjalnie wyprofilowana pokrywa odprowadzająca skropliny do pojemnika barmarowego.

Verlo



Podgrzewacz okrągły z podstawą; 18/10

Nr kat.	l cm	h cm	w cm	cap l	PLN	EUR
V-1100-08	53	35	50	6	999,00	-

Pokrywa z hydraulicznym systemem hamującym • Nienagrzewający się uchwyt pokrywy • Teleskopy dla łatwego i bezpiecznego sztaplowania • Specjalnie wyprofilowana pokrywa odprowadzająca skropliny do pojemnika barmarowego.

abert



Urna do kawy; 18/10

Nr kat.	l cm	h cm	w cm	cap l	PLN	EUR
AB-7605-001	24	61	31	10	999,00	-

Verlo



Dyspenser do soku Supreme; 18/10

Nr kat.	l cm	h cm	w cm	cap l	PLN	EUR
V-1140-12	36	46	36	12	1 480,77	-

Tuba na lód

abert



Dyspenser do soku; 18/10, PC

Nr kat.	l cm	h cm	w cm	cap l	PLN	EUR
AB-7605-002	23,5	50	31	7	2 245,64	-

abert



Dyspenser do płatków; 18/10, PC

Nr kat.	l cm	h cm	w cm	cap l	PLN	EUR
AB-7605-011	18	68	27	7	1 855,38	-



Dyspenser do soku i mleka; 18/10, SAN

Nr kat.	l cm	h cm	w cm	PLN	EUR
TF-864	35	48	45	999,00	-

Pojemniki: na sok wykonany z przezroczystego tworzywa, na mleko z matowego • System chłodzący w podstawie i pokrywach



Dyspenser do mleka; 18/10

Nr kat.	l cm	h cm	w cm	cap l	PLN	EUR
T-VGD41	35	55	26	8	249,00	-

Wewnątrz tuba na lód do schładzania mleka

abert



Panel; MDF

Nr kat.	l cm	w cm	PLN	EUR
AB-M4242	42	42	39,00	-

abert



Panel; lupok

Nr kat.	l cm	w cm	PLN	EUR
AB-L4210	100	42	249,00	-

abert

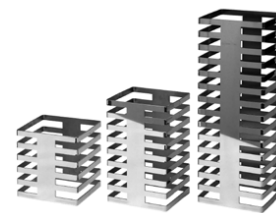

Kolumna; 18/10

Nr kat.	h cm	PLN	EUR
AB-3050-22	22	743,00	-
AB-3050-34	34	1 053,83	-
AB-3050-58	58	1 836,33	-

Verlo



Tuba; akryl

Nr kat.	Ø cm	h cm	col	PLN	EUR
V-7514	20	10	przezroczysty	53,39	-
V-7515	20	20	przezroczysty	105,83	-

abert



Stojak pod pojemnik chłodzący AB-7654; 18/10

Nr kat.	l cm	w cm	PLN	EUR
AB-7615	50	30	239,00	-

Verlo



Podstawa bufetowa - chromowana

Nr kat.	l cm	w cm	PLN	EUR
TF-501	53	32,5	89,00	-

Verlo



Podwyższenie bufetowe; akryl

Nr kat.	l cm	h cm	w cm	PLN	EUR
V-7511	29,5	4	29,5	84,47	-
V-7512	29,5	8	29,5	102,75	-



Stojak bufetowy; 18/0

Nr kat.	l cm	h cm	w cm	PLN	EUR
TF-342	39	17	39	129,00	-

Bez wyposażenia w naczynia



Pokrywa na talerz - poliwęglan

Nr kat.	Ø cm	h cm	op.	PLN	EUR
CM-1007CW152	27	7	12	21,00	-

KUP ON-LINE





Pojemnik kwadratowy

Nr kat.	l cm	h cm	w cm	PLN	EUR
AB-VQ1	23	4	23	109,00	-



Deska kwadratowa z rantem pod skrzynki

Nr kat.	l cm	h cm	w cm	PLN	EUR
AB-SQ1	23	7,5	23	109,00	-



Skrzynka pełna GN 1/4

Nr kat.	l cm	h cm	w cm	PLN	EUR
CL-FF013	26,5	4	16,25	99,00	-

Orzech • Drewno naturalne, sezonowane



CAMBRO

Taca Capri granit węgielny

Nr kat.	l cm	w cm	PLN	EUR
CM-CA3446E82	46	34	15,00	-

Odporność na temperaturę: -10° do +100°C



CAMBRO

Taca samoobsługowa Mykonos; melamina, papier

Nr kat.	l cm	w cm	PLN	EUR
CM-MY3343	43	33	29,00	-



Ambasador taca M (op. 2 szt.)

Nr kat.	l cm	h cm	w cm	PLN	EUR
SL-ES40020	19	1,5	27,5	8,00	-



Ambasador taca L (op. 2 szt.)

Nr kat.	l cm	h cm	w cm	PLN	EUR
SL-ES40010	25,6	1,5	27,5	9,00	-



Taca Ambasador; papier

Nr kat.	l cm	h cm	w cm	op.	PLN	EUR
FF-ES40000	38	1,5	27,5	2	15,00	-

Powyższa cena jest ceną za opakowanie. Ilość szt. w opakowaniu: 2.



Verlo



Tablica informacyjna; dąb, PCV

Nr kat.	l cm	w cm	thk mm	PLN	EUR
V-99223	34	21	40	68,29	-
V-99224	25	14,8	40	35,28	-

Podstawa wykonana z drewna dębowego • tablica ze spienionego PCV

Verlo



Tablica informacyjna; dąb

Nr kat.	l cm	w cm	thk mm	PLN	EUR
V-99226	25	14,8	40	80,89	-

Podstawa wykonana z drewna dębowego • tablica ze sklejki fornirowanej



Zestaw stojaków na menu; akryl

Nr kat.	l cm	w cm	PLN	EUR
TF-044	3	3	54,69	-

Zestaw: 4 stojaki z akrylu i 20 białych etykiet (8,5 x 5,5 cm)



Świecznik; 18/10, szkło

Nr kat.	Ø cm	h cm	PLN	EUR
T-11103	8	13,5	9,00	-

abert



Ring do serwet; 18/10

Nr kat.	Ø cm	PLN	EUR
AB-5801	4	21,19	-



Tabliczka - Zakaz używania telefonów

Nr kat.	Ø cm	PLN	EUR
DH-3903-075	7,5	5,00	-



Tabliczka - przystosowane dla niepełnosprawnych; 18/10

Nr kat.	Ø cm	thk mm	PLN	EUR
T-3904-075	7,5	1	9,76	-



Tabliczka na WC - kobiety; 18/10

Nr kat.	Ø cm	thk mm	PLN	EUR
T-3902-075	7,5	1	9,76	-



Tabliczka na WC - mężczyźni; 18/10

Nr kat.	Ø cm	thk mm	PLN	EUR
T-3901-075	7,5	1	9,76	-



abert

Pyramid - stojak bufetowy

Nr kat.	l cm	h cm	w cm	PLN	EUR
AB-766	29,5	50	36,5	399,00	-

abert



Urban - ekspozytor czarny

Nr kat.	l cm	h cm	w cm	PLN	EUR
AB-8742-22	34	22	34	59,00	-

Stal malowana proszkowo. Błat szklany dostępny oddzielnie.

abert



Podstawa; 18/10

Nr kat.	l cm	h cm	w cm	PLN	EUR
AB-3042-14	34	14	34	326,82	-
AB-3042-22	34	22	34	424,64	-

KUP ON-LINE





Dessert

Nr kat.	Ø cm	h cm	cap ml	kosz	op.	PLN	EUR
LB-3803-12	11,1	8,6	239	95434	12	11,00	-



Pojemnik z pipetą tworzywo

Nr kat.	l cm	h cm	w cm	cap ml	op.	PLN	EUR
161211	6	7	5	80	18	15,00	-



Zeda biała tworzywo (op.20 szt)

Nr kat.	l cm	h cm	w cm	cap ml	op.	PLN	EUR
FF-MB18B	4	8	4	60	20	99,00	-

Powyższa cena jest ceną za opakowanie. Ilość szt. w opakowaniu: 20.
Price per pack. Quantity in package: 20. Price per item: 0,29 EUR



Kula XL tworzywo (op. 100 szt)

Nr kat.	Ø cm	cap ml	PLN	EUR
FF-BPC30	11	300	149,00	-



Kieliszek srebrny (op. 60 szt)

Nr kat.	Ø cm	h cm	cap ml	PLN	EUR
SL-BU50104-10	4,4	6,2	50	39,00	-



Czapka Chefa S (op. 10 szt)

Nr kat.	Ø cm	h cm	cap ml	PLN	EUR
SL-PS32602-30	4	6,2	50	3,00	-



Kubek gniewiony czarny tworzywo (op. 12 szt)

Nr kat.	Ø cm	h cm	cap ml	op.	PLN	EUR
FF-VSK6N	5,8	5,2	60	12	4,00	-

Powyższa cena jest ceną za opakowanie. Ilość szt. w opakowaniu: 12.



Barok czarny M tworzywo (op. 300 szt)

Nr kat.	Ø cm	h cm	cap ml	PLN	EUR
FF-VB6N	4,9	6,2	60	39,00	-





Crystallo pucharek; PS

Nr kat.	Ø cm	h cm	cap ml	op.	PLN	EUR
FF-127724	6	9	200	20	7,00	-

Powyższa cena jest ceną za opakowanie. Ilość szt. w opakowaniu: 20.



Crystallo pokrywka do pucharka; PS

Nr kat.	Ø cm	h cm	op.	PLN	EUR
FF-118890	6	2	20	2,00	-

Powyższa cena jest ceną za opakowanie. Ilość szt. w opakowaniu: 20.



Rożek bambusowy

Nr kat.	Ø cm	h cm	op.	PLN	EUR
FF-VO13401	5	13	100	39,00	-
FF-VO13402	7	17	100	39,00	-

Powyższa cena jest ceną za opakowanie. Ilość szt. w opakowaniu: 100.



Ekspozytor; akryl

Nr kat.	l cm	w cm	PLN	EUR	
FF-SC00004	poj. 30 szt.	38	35	99,00	-



Naczynie; papier

Nr kat.	l cm	h cm	w cm	cap ml	op.	PLN	EUR
FF-KN60	5	4,5	5	60	300	99,00	-

Powyższa cena jest ceną za opakowanie. Ilość szt. w opakowaniu: 300.



Serwetki dwuwarstwowe

Nr kat.	l cm	w cm	PLN	EUR
GS-11712-4	38	38	10,00	-



FINGERFOOD

OUTLET



Brocheta biała tworzywo (op.350 szt)

Nr kat.	l cm	PLN	EUR
CO-SBR18B	18	69,00	-



Patyczek tworzywo(op.1200 szt.)

Nr kat.	l cm	op.	PLN	EUR
FF-159720	9	1200	25,00	-

Powyższa cena jest ceną za opakowanie. Ilość szt. w opakowaniu: 1200.



Patyczek czarny tworzywo (op.500 szt)

Nr kat.	l cm	op.	PLN	EUR
FF-STIKP2	10	500	39,00	-

Powyższa cena jest ceną za opakowanie. Ilość szt. w opakowaniu: 500.



Widelczyki tworzywo(op.250 szt.)

Nr kat.	l cm	op.	PLN	EUR
FF-16693	11	250	7,00	-

Powyższa cena jest ceną za opakowanie. Ilość szt. w opakowaniu: 250.



Śruba czarna L tworzywo (op.1000 szt)

Nr kat.	l cm	op.	PLN	EUR
FF-VIS150	15	1000	149,00	-
FF-VIS80	8	1000	149,00	-

Powyższa cena jest ceną za opakowanie. Ilość szt. w opakowaniu: 1000.



Patyczki bambusowe

Nr kat.	l cm	op.	PLN	EUR
V-30008	12	100	6,41	-

Verlo



Patyczki bambusowe

Nr kat.	l cm	op.	PLN	EUR
V-30010	9	100	6,13	-

Verlo



Verlo

Patyczki bambusowe

Nr kat.	l cm	op.	PLN	EUR
V-30011	9	100	7,41	-



Verlo

Patyczki bambusowe Medium

Nr kat.	l cm	op.	PLN	EUR
V-30021	9	100	5,49	-



Verlo

Patyczki bambusowe Rare

Nr kat.	l cm	op.	PLN	EUR
V-30022	9	100	5,49	-



Verlo

Patyczki bambusowe Well

Nr kat.	l cm	op.	PLN	EUR
V-30020	9	100	5,49	-

KUP ON-LINE





Talerz

Nr kat.	Ø cm	op.	PLN	EUR
V-85010-6	28,5	6	19,00	-



Talerz

Nr kat.	l cm	w cm	op.	PLN	EUR
V-85003-6	43	22,5	6	29,00	-



Talerz

Nr kat.	l cm	w cm	op.	PLN	EUR
V-85012-6	28	20	6	19,00	-



Talerz

Nr kat.	l cm	w cm	op.	PLN	EUR
V-85014-6	34	24	6	19,00	-



Miska

Nr kat.	Ø cm	cap ml	op.	PLN	EUR
V-85004-6	10	200	6	15,00	-



Miska

Nr kat.	Ø cm	cap ml	op.	PLN	EUR
V-85006-4	23	1200	4	19,00	-



White Gold talerz płaski

Nr kat.	Ø cm	PLN	EUR
R-GDRP16-24	16	15,00	-
R-GDRP22-12	22	10,00	-



Line-Z talerz płaski okrągły

Nr kat.	Ø cm	PLN	EUR
R-LZFP17-24	15	8,00	-



Talerz płaski gourmet

Nr kat.	Ø cm	op.	PLN	EUR
R-FDGF29PLA-12	29	12	59,00	-



AllSpice talerz prostokątny Coriandre

Nr kat.	l cm	w cm	op.	PLN	EUR
R-SPRS29-6	28,7	22	6	29,00	-



Talerz kwadratowy ALL SPICE

Nr kat.	l cm	w cm	op.	PLN	EUR
R-SPSP4B-6	30	30	6	39,00	-



Talerz płaski

Nr kat.	l cm	w cm	op.	PLN	EUR
R-AUSP33-6	33	33	6	62,00	-



Giro talerz płaski

Nr kat.	Ø cm	PLN	EUR
R-GIFP15-24	15	9,00	-



Bulionówka z pokrywą

Nr kat.	Ø cm	cap ml	op.	PLN	EUR
R-NNCS27-6	12	270	6	13,00	-

Pokrywka

Nr kat.	op.	PLN	EUR
R-NNCS27LD-12	<i>pokrywka zapasowa</i> 12	8,78	-

Spodek pod bulionówkę

Nr kat.	Ø cm	op.	PLN	EUR
R-NNST16-12	<i>spodek</i> 16	12	12,54	-



White Gold waza do zupy z pokrywą

Nr kat.	cap ml	PLN	EUR
R-GDSB340-1	340	77,00	-



Ska bulionówka

Nr kat.	Ø cm	h cm	cap ml	op.	PLN	EUR
R-SKCS30-12	10	6	300	12	9,00	-



White Gold kubek

Nr kat.	Ø cm	cap ml	PLN	EUR
R-GDCU09M-12	6,4	90	9,00	-



Massilia filiżanka do espresso

Nr kat.	Ø cm	h cm	cap ml	op.	PLN	EUR
R-MSCU10-12	6	5,7	110	12	7,00	-



Nabur filiżanka do kawy/herbaty

Nr kat.	Ø cm	h cm	cap ml	op.	PLN	EUR
R-NBCU26-12	8,7	7,5	260	12	9,00	-



Nabur spodek do filiżanka NBCU09

Nr kat.	l cm	w cm	PLN	EUR
R-NBSA15-12	15	12,5	5,00	-



Nabur spodek do filiżanek NBCU34 i NBCU26

Nr kat.	l cm	w cm	op.	PLN	EUR
R-NBSA18-12	18	15	12	6,00	-



Access Mlecznik

Nr kat.	Ø cm	h cm	cap ml	op.	PLN	EUR
R-ASCR15-12	6,9	7,7	150	12	10,00	-



Access Wazon

Nr kat.	h cm	op.	PLN	EUR
R-ASFV01-12	12	12	14,00	-





Buffet naczynie okrągłe

Nr kat.	Ø cm	cap ml	cap l	PLN	EUR
R-BUSD22-8	22,4	1000	1	49,00	-



Kociotek

Nr kat.	Ø cm	h cm	cap ml	op.	PLN	EUR
R-CFRD10BKBD-12	10	5,2	216	12	19,00	-



Talerz płaski

Nr kat.	Ø cm	h cm	op.	PLN	EUR
R-EACP16FG-24	16,2	2	24	22,00	-
R-EACP32FG-6	31,7	2,3	6	69,00	-



Talerz płaski

Nr kat.	Ø cm	h cm	op.	PLN	EUR
R-EAFP24FG-12	23,7	2,2	12	30,00	-
R-EAFP28FG-12	27,6	2,4	12	42,00	-
R-EAFP32FG-6	31,8	2,3	6	65,00	-



Talerz głęboki

Nr kat.	Ø cm	h cm	cap ml	op.	PLN	EUR
R-EADC24FG-2	23,7	4,6	1300	2	39,00	-



Półmisek

Nr kat.	l cm	h cm	w cm	op.	PLN	EUR
R-EAOP23FG-12	23	3,1	15	12	33,00	-



Karbon miseczka

Nr kat.	Ø cm	h cm	cap ml	op.	PLN	EUR
R-KRNNBW09-12	9	4	110	12	13,00	-



Kubek

Nr kat.	Ø cm	h cm	cap ml	op.	PLN	EUR
R-EACU23MFG-12	7,3	9,2	230	12	21,00	-





Miska

Nr kat.	Ø cm	cap ml	op.	PLN	EUR
R-TWNNBW20CO-6	20	900	6	29,00	-



Talerz płaski

Nr kat.	Ø cm	op.	PLN	EUR
R-TWNNPR15BE-24	15	24	11,00	-



Talerz głęboki

Nr kat.	Ø cm	cap ml	op.	PLN	EUR
R-LEBUBC30BL-6	30	1900	6	39,00	-



NEOFUSION misa płaska brązowa

Nr kat.	Ø cm	cap ml	PLN	EUR
R-NFBUBC30BW-6	30	1900	29,00	-

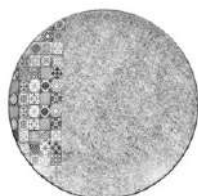

Talerz płaski Splendour

Nr kat.	Ø cm	op.	PLN	EUR
R-SRNNPR21-12	21	12	14,00	-



Miseczka Splendour

Nr kat.	Ø cm	h cm	cap ml	op.	PLN	EUR
R-SRNOBW14-12	14	6	680	12	22,00	-



Contour Łyżka do bulionu

Nr kat.	l cm	op.	PLN	EUR
HP-01-0036-1630	17,2	12	5,00	-



Michelangelo Łyżka deserowa

Nr kat.	l cm	op.	PLN	EUR
HP-01-0043-1050	18,2	12	5,00	-



Baguette Łyżka stołowa

Nr kat.	l cm	op.	PLN	EUR
HP-01-0032-1010	20,5	12	5,00	-



Trend Nóż do ryb

Nr kat.	l cm	op.	PLN	EUR
HP-06-0047-1730	20,3	12	5,00	-



Royal Łyżka do bulionu

Nr kat.	l cm	op.	PLN	EUR
HP-01-0049-1630	17,8	12	5,00	-



Royal Widelec stołowy

Nr kat.	l cm	op.	PLN	EUR
HP-01-0049-1020	20,8	12	5,00	-



Royal Nóż stołowy

Nr kat.	l cm	op.	PLN	EUR
HP-01-0049-1800	23,7	12	5,00	-



Royal Widelec do ryb

Nr kat.	l cm	op.	PLN	EUR
HP-01-0049-1150	17,8	12	5,00	-



Royal Nóż do ryb

Nr kat.	l cm	op.	PLN	EUR
HP-01-0049-1140	20,3	12	5,00	-



Royal Nóż do steków

Nr kat.	l cm	op.	PLN	EUR
HP-01-0049-1950	23,4	12	5,00	-



Royal Widelec deserowy

Nr kat.	l cm	op.	PLN	EUR
HP-01-0049-1060	18	12	5,00	-



Royal Łyżka do latte

Nr kat.	l cm	op.	PLN	EUR
HP-01-0049-1210	19,2	12	5,00	-



SZTUĆCE



SU Widelec do ryby

Nr kat.	l cm	thk mm	PLN	EUR
V-7000-16	18,3	35	4,00	-



Nóż przystawkowy

Nr kat.	l cm	g	op.	PLN	EUR
E-1810-6V-12	21,3	110	12	9,00	-



Atlantis nóż przystawkowy

Nr kat.	l cm	op.	PLN	EUR
E-3010-61	21,3	12	9,00	-



Widelec do steków

Nr kat.	l cm	PLN	EUR
TR-9818	19,5	2,50	-

TRAMONTINA



Jednorazowy zestaw sztućców stalowych z serwetką; 18/10

Nr kat.	PLN	EUR
E-430-S4	3,01	-



Doria nóż do steków

Nr kat.	l cm	op.	PLN	EUR
E-8004-45	21,4	12	8,00	-

eternum



Nóż do trybowania; X50CrMoV15

Nr kat.	l cm	PLN	EUR
W-1010531414	14	359,00	-

WÜSTHOF

KUP ON-LINE





ZWIESEL
GLAS



Sparkling wine

SH-8900-7-6

277 ml, op. 6
h: 170 mm, Ø: 64 mm

PLN/EUR: 5,00 / -

365638



LIBBEY

LB-7518-12

ml, op. 12
PLN/EUR: 8,00 / -

95800



LIBBEY

LB-400-12

244 ml, op. 12
h: 98 mm, Ø: 102 mm

PLN/EUR: 9,00 / -

205434



LIBBEY

LB-15431-12

148 ml, op. 12
h: 73 mm, Ø: 73 mm

PLN/EUR: 8,00 / -

305318



LIBBEY

LB-3060-24

590 ml, op. 12
h: 226 mm, Ø: 99 mm

PLN/EUR: 11,00 / -

165900



LIBBEY

LB-92412-12

237 ml, op. 12
h: 187 mm, Ø: 117 mm

PLN/EUR: 13,00 / -

95800



LIBBEY

LB-15712-12

355 ml, op. 12
h: 105 mm, Ø: 98 mm

PLN/EUR: 6,00 / -

205434



LIBBEY

LB-15454-36

237 ml, op. 36
h: 85 mm, Ø: 79 mm

PLN/EUR: 7,00 / -

305958



LIBBEY

LB-222203-12

540 ml, op. 12
h: 139 mm, Ø: 102 mm

PLN/EUR: 6,00 / -



LIBBEY

LB-3771-12

148 ml, op. 12
h: 132 mm, Ø: 96 mm

PLN/EUR: 11,00 / -

205434



LIBBEY

LB-92405-12

355 ml, op. 12
h: 152 mm, Ø: 73 mm

PLN/EUR: 11,00 / -

305638



LIBBEY

LB-15238-12

350 ml, op. 12
h: 124 mm, Ø: 85 mm

PLN/EUR: 3,00 / -

255434



LIBBEY

LB-613285-4

800 ml, op. 4
h: 154 mm, Ø: 115 mm

PLN/EUR: 11,00 / -

95638Y



LIBBEY

LB-4116SRB-12

480 ml, op. 12
h: 178 mm, Ø: 89 mm

PLN/EUR: 11,00 / -

205800



LIBBEY

LB-51-72

370 ml, op. 72
h: 133 mm, Ø: 73 mm

PLN/EUR: 3,00 / -

305638



LIBBEY

LB-15665-24

590 ml, op. 24
h: 171 mm, Ø: 95 mm

PLN/EUR: 6,00 / -

205638





LB-928020-6
450 ml, op. 6
h: 117 mm, Ø: 85 mm
PLN/EUR: 6,00 / -
 25S434



LB-5130-36
140 ml, op. 36
h: 79 mm, Ø: 73 mm
PLN/EUR: 3,00 / -
 30S318



LB-15795-12
355 ml, op. 12
h: 110 mm, Ø: 96 mm
PLN/EUR: 6,00 / -
 20S434



LB-933208-12
237 ml, op. 12
h: 92 mm, Ø: 70 mm
PLN/EUR: 5,00 / -
 36S418



LB-5310-24
340 ml, op. 24
h: 181 mm, Ø: 83 mm
PLN/EUR: 13,00 / -
 25S738



LB-3722-6
470 ml, op. 6
h: 181 mm, Ø: 87 mm
PLN/EUR: 8,00 / -
 25S738



LB-19-12
340 ml, op. 12
h: 171 mm, Ø: 84 mm
PLN/EUR: 6,00 / -
 25S738



LB-92417-12
414 ml, op. 12
h: 177 mm, Ø: 73 mm
PLN/EUR: 13,00 / -
 30S800



LB-92103-12
473 ml, op. 12
h: 134 mm, Ø: 78 mm
PLN/EUR: 5,00 / -
 30S434



MB-20W
200 ml, op.
h: 88 mm, Ø: 80 mm
PLN/EUR: 6,62 / -
 25S318
Materiał: poliwęglan



MB-20B
200 ml, op.
h: 88 mm, Ø: 80 mm
PLN/EUR: 6,62 / -
 25S318
Materiał: poliwęglan



Szlanka do shakera; szkło

Nr kat.	cap ml	op.	PLN	EUR
LB-15647-1	592	12	10,00	-



100%Chef

Zestaw do aromatyzowania dymem Perfect Smoking

Nr kat.	PLN	EUR
C1-1038	259,00	-

W skład zestawu wchodzi butelka: 1l, szklany cybuch, popielnik, nakładka na butelkę, pompka • Idealne do aromatyzowania dymem większej ilości płynu.

BarEq



Dyspenser barmański z miejscem na butelki; 18/10

Nr kat.	l cm	h cm	w cm	PLN	EUR
T-111-12	88,5	13,5	25,5	169,00	-

Możliwość powieszenia na ścianie



Nalewak/porcjomierz czerwony

Nr kat.	cap ml	PLN	EUR
BH-98150	50	8,28	-



100%Chef

Szkło degustacyjne Smoke & Drink

Nr kat.	cap ml	PLN	EUR
C1-1609	100	99,00	-

Wymiary fajki: śr. 5,5 cm, dł. 16 cm, wys. 7 cm



Talerz kwadratowy Tempo

Nr kat.	l cm	h cm	PLN	EUR
LB-1794709-12U	20	1,6	5,00	-



100%Chef

Ekspozytor - szkło borowe

Nr kat.	Ø cm	PLN	EUR
C1-1024-6	15	59,00	-

BAR I KAWIARNIA



Rurki bambus; papier

Nr kat.	Ø cm	l cm	op.	PLN	EUR
FF-2108BB	0,8	21	100	11,69	-
FF-2508BB	0,8	25	100	13,97	-

Powyższa cena jest ceną za opakowanie. Ilość szt. w opakowaniu: 100.



Rurki czarne; papier

Nr kat.	Ø cm	l cm	op.	PLN	EUR
FF-2108PK	0,8	21	100	11,69	-
FF-2508PK	0,8	25	100	13,97	-

Powyższa cena jest ceną za opakowanie. Ilość szt. w opakowaniu: 100.



Rurki natural; papier

Nr kat.	Ø cm	l cm	op.	PLN	EUR
FF-1408P	0,8	14	100	8,12	-
FF-2508P	0,8	25	100	13,97	-

Powyższa cena jest ceną za opakowanie. Ilość szt. w opakowaniu: 100.



Rurki szare; papier

Nr kat.	Ø cm	l cm	op.	PLN	EUR
FF-1408S	0,8	14	100	8,12	-
FF-2508S	0,8	25	100	13,97	-

Powyższa cena jest ceną za opakowanie. Ilość szt. w opakowaniu: 100.



Rurki zielone; papier

Nr kat.	Ø cm	l cm	op.	PLN	EUR
FF-2108PG	0,8	21	100	11,69	-

Powyższa cena jest ceną za opakowanie. Ilość szt. w opakowaniu: 100.



Rurki różowe; papier

Nr kat.	Ø cm	l cm	op.	PLN	EUR
FF-2108PF	0,8	21	100	11,69	-

Powyższa cena jest ceną za opakowanie. Ilość szt. w opakowaniu: 100.

KOSZE NA ŚMIECI



Kosz na śmieci, metalowy okrągły

Nr kat.	Ø cm	h cm	PLN	EUR
8001	25	33,5	15,00	-



Kosz na śmieci, metalowy prostokątny

Nr kat.	l cm	h cm	w cm	PLN	EUR
8002	31,5	25	25	15,00	-



Kosz na śmieci z pokrywą, stal.wysokopolerowana

Nr kat.	Ø cm	h cm	cap l	PLN	EUR
B03S	17	26	3	14,00	-

KUP ON-LINE

